



Modern Concrete Construction

Arch 173: Building Construction 2

Winter 2024

Terri Meyer Boake





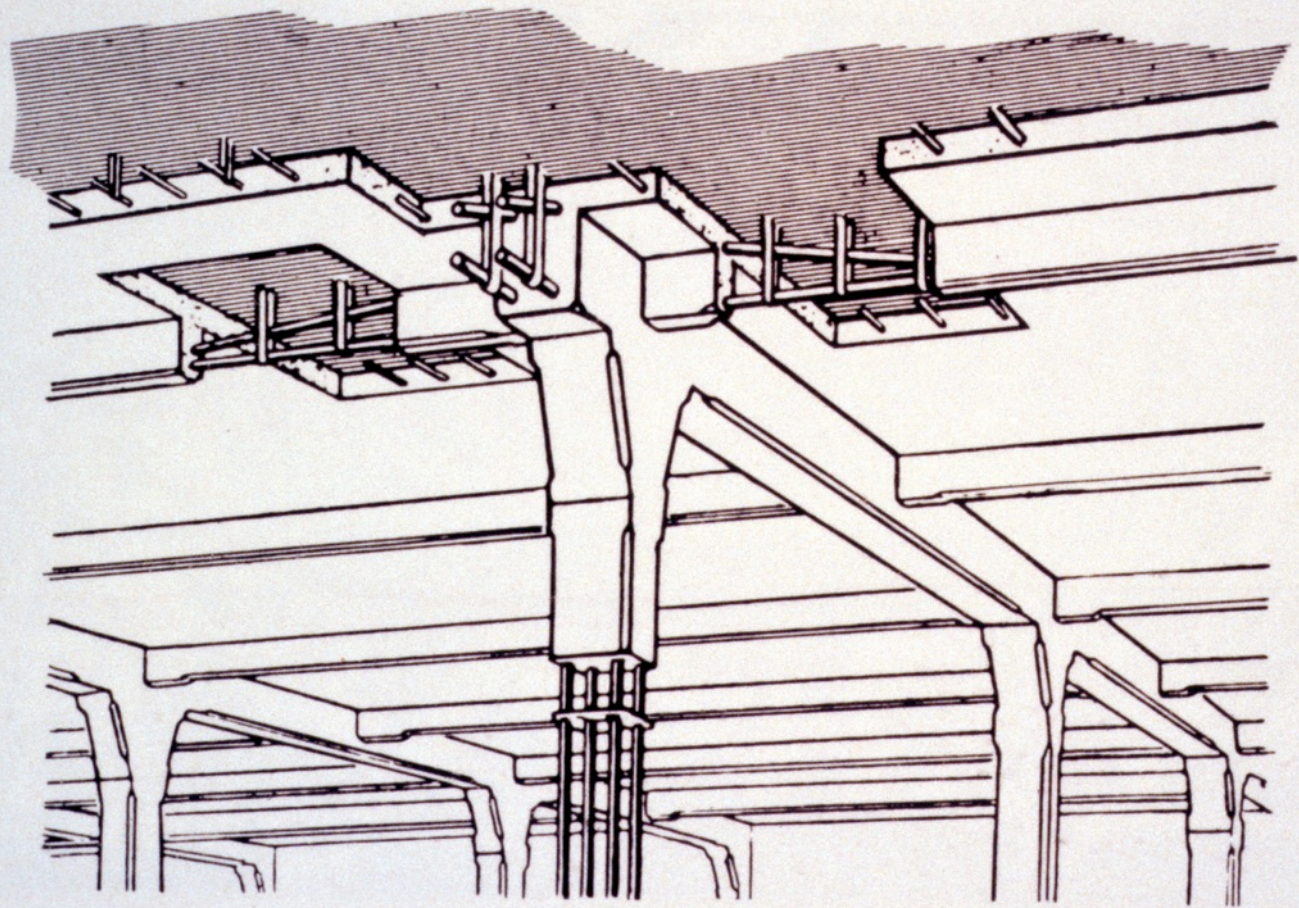

16 *Hennebique, patent reinforced concrete frame construction, 1892.*























Primary ingredients of concrete:

Large aggregates

Small aggregates

Cement

Water





Reinforcing Steel – AKA "rebar"

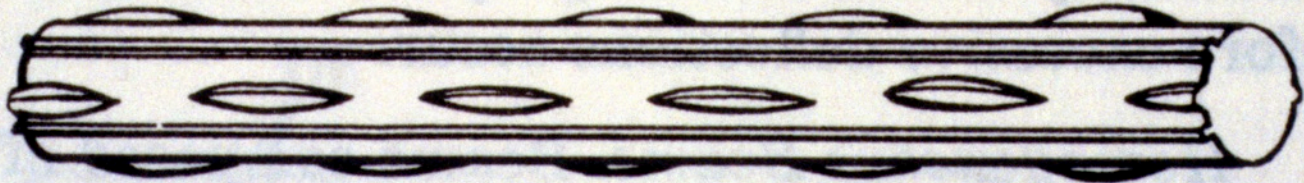

Steel Reinforcing Bars  
Figure 19-2





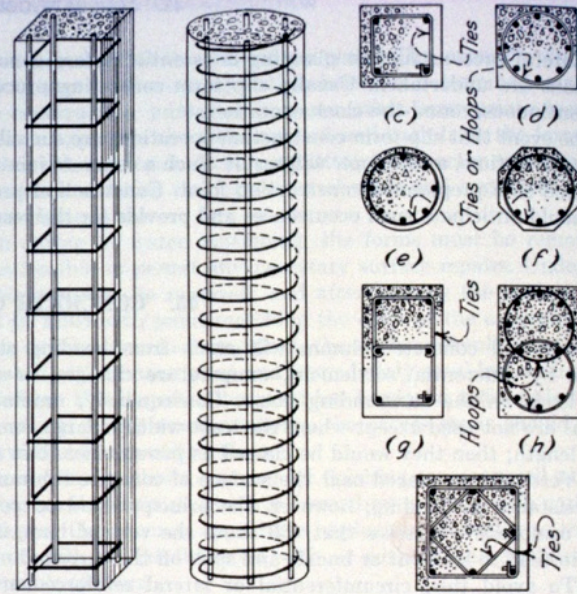

(a) Ties

(b) Spiral

(i)

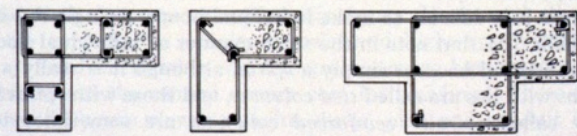

(j) Tied Corner Column

(k) Tied Wall Column  
W-Section

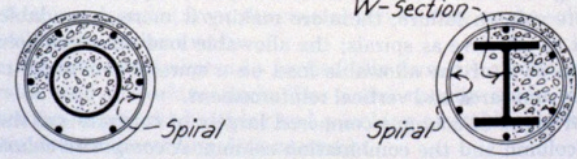

(l) Composite Column-Cast-Iron Core (m) Composite Column-Steel Core

FIGURE 7.4 Reinforced concrete columns.



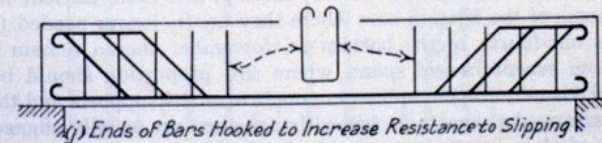
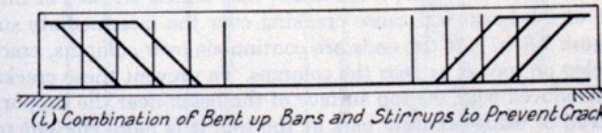
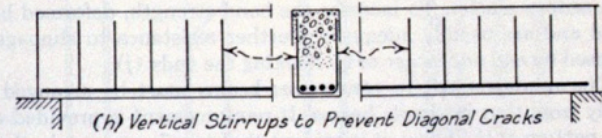
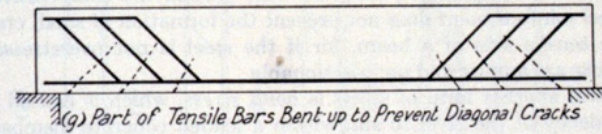
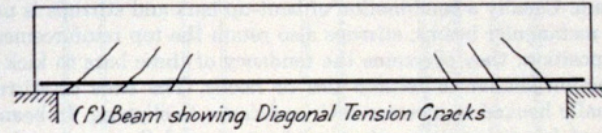
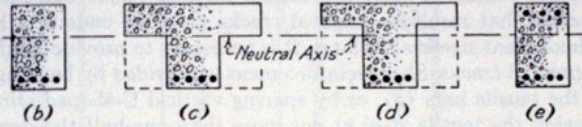
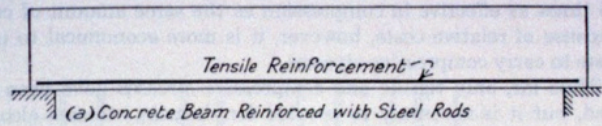

FIGURE 7.5 Simple reinforced concrete beams.



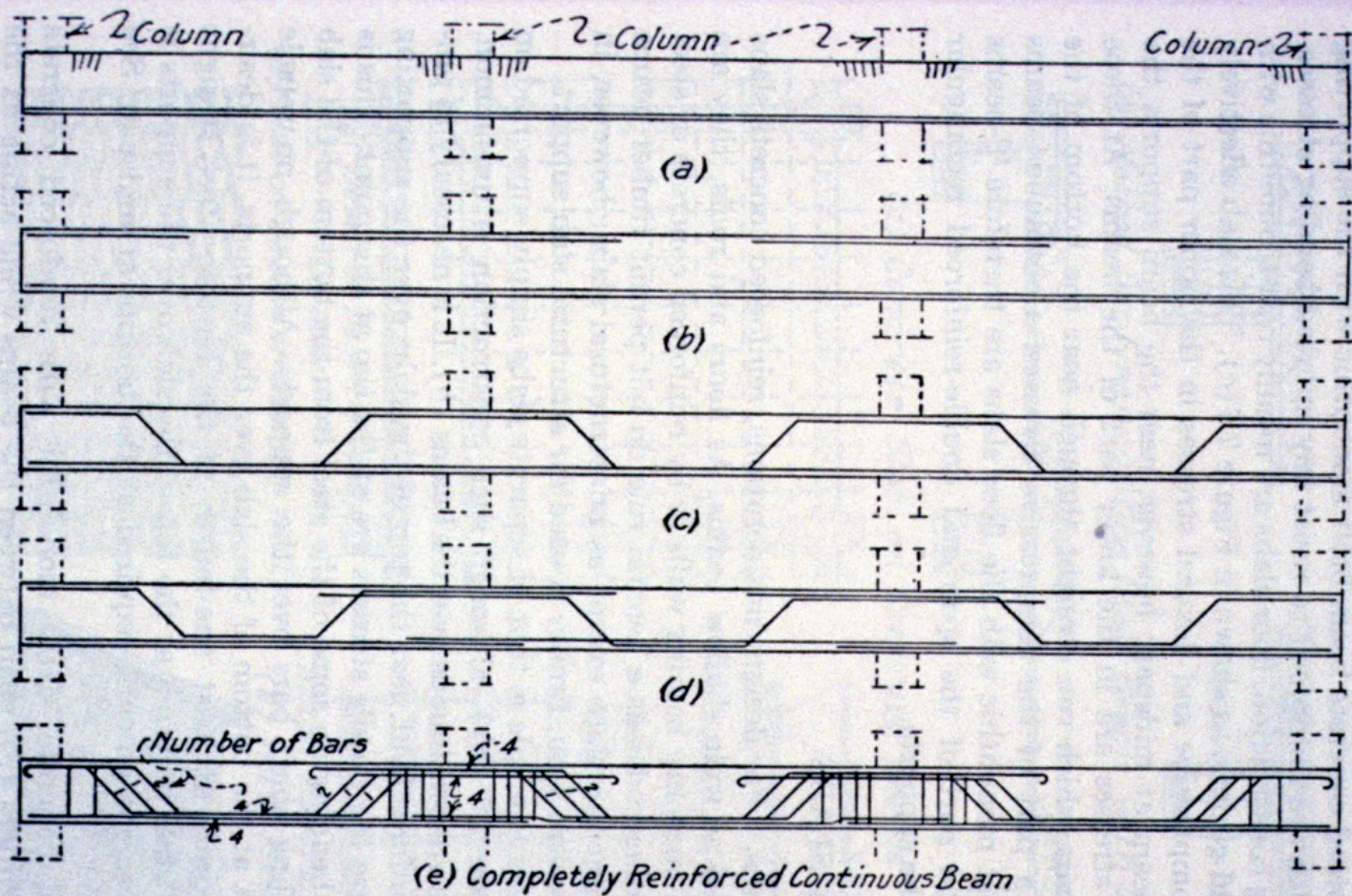
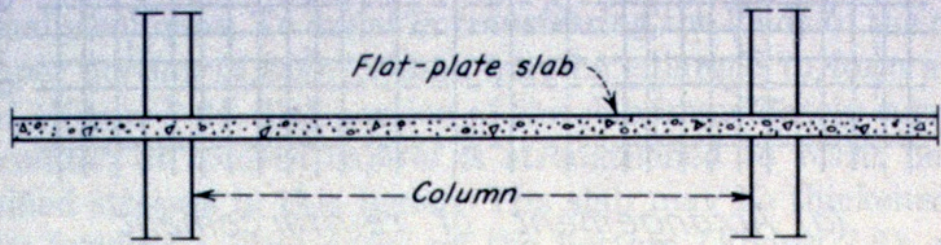
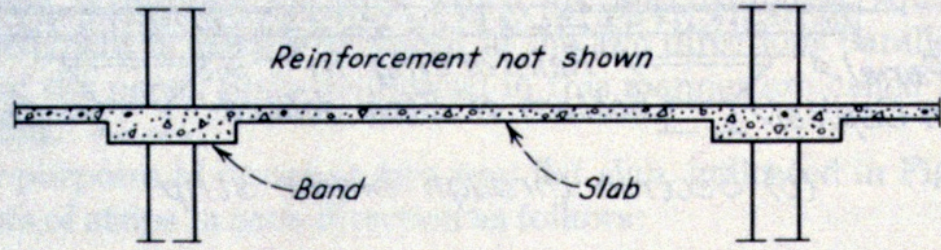

FIGURE 7.6 Continuous reinforced concrete beams.





(a) Flat-plate construction



(b) Slab-band construction

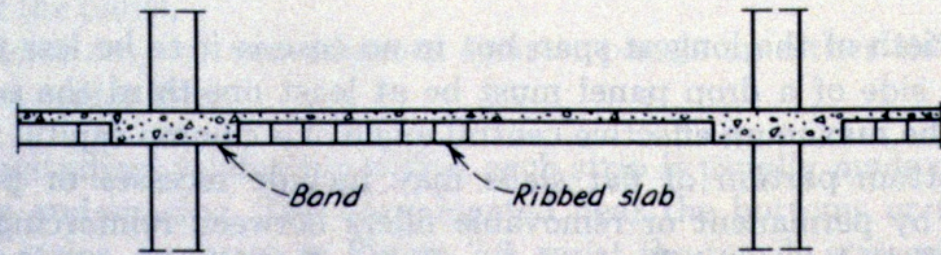

(c) Ribbed slab-band construction

FIGURE 7.9 Flat-plate and slab-band floor construction.



**Two-Way Flat Plate**

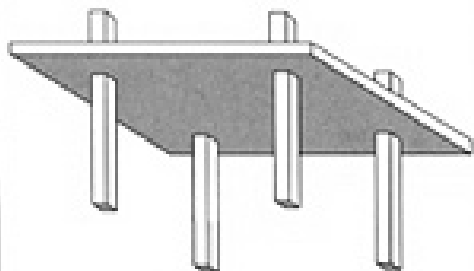

**Two-Way Flat Slab with Drop Panels**

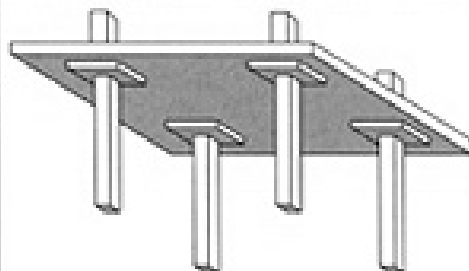

**One-Way Beam and Slab**

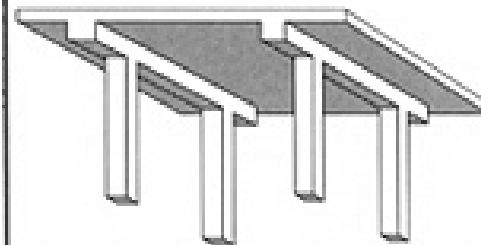

**One-Way Joist Slab**

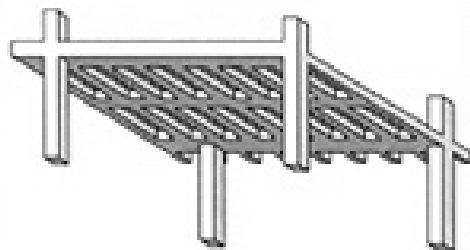

**One-Way Wide Module Joist Slab**

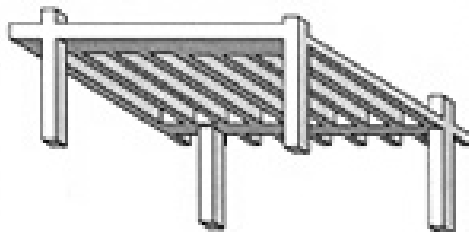

**Two-Way Joist Slab (Waffle)**

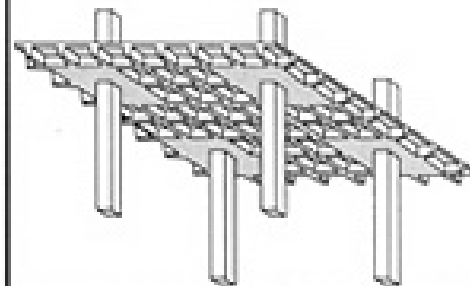

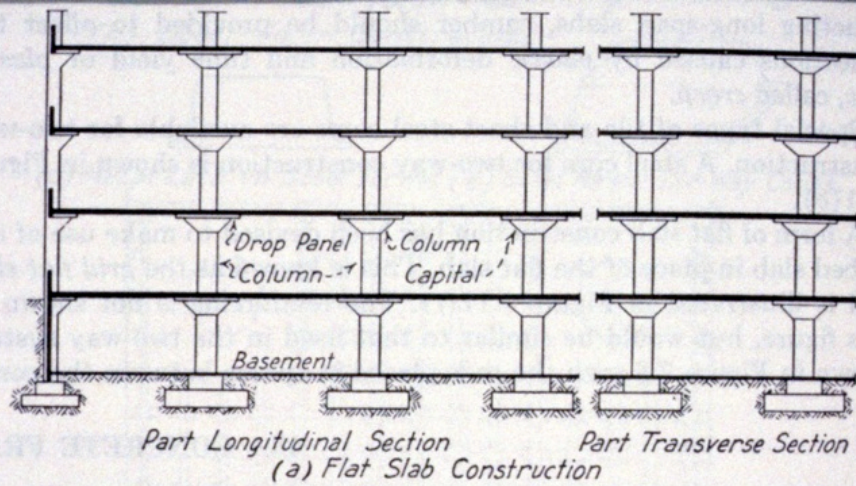

Part Longitudinal Section      Part Transverse Section  
 (a) Flat Slab Construction

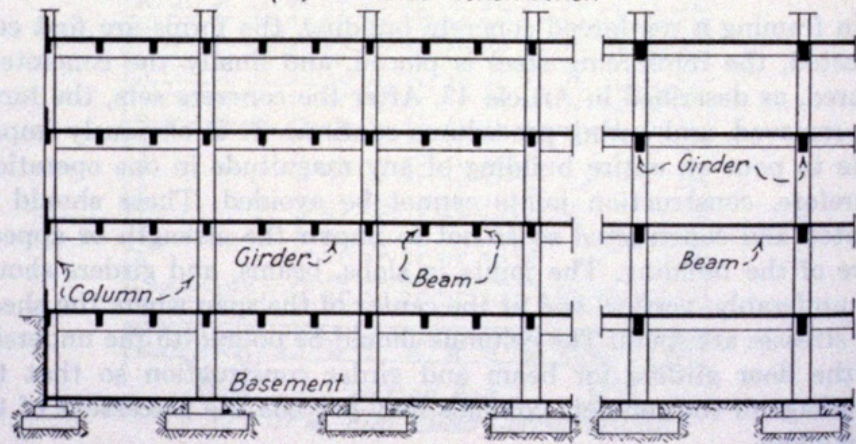

Part Longitudinal Section      Part Transverse Section  
 (b) Beam and Girder Construction

FIGURE 7.12 Types of reinforced concrete framing.



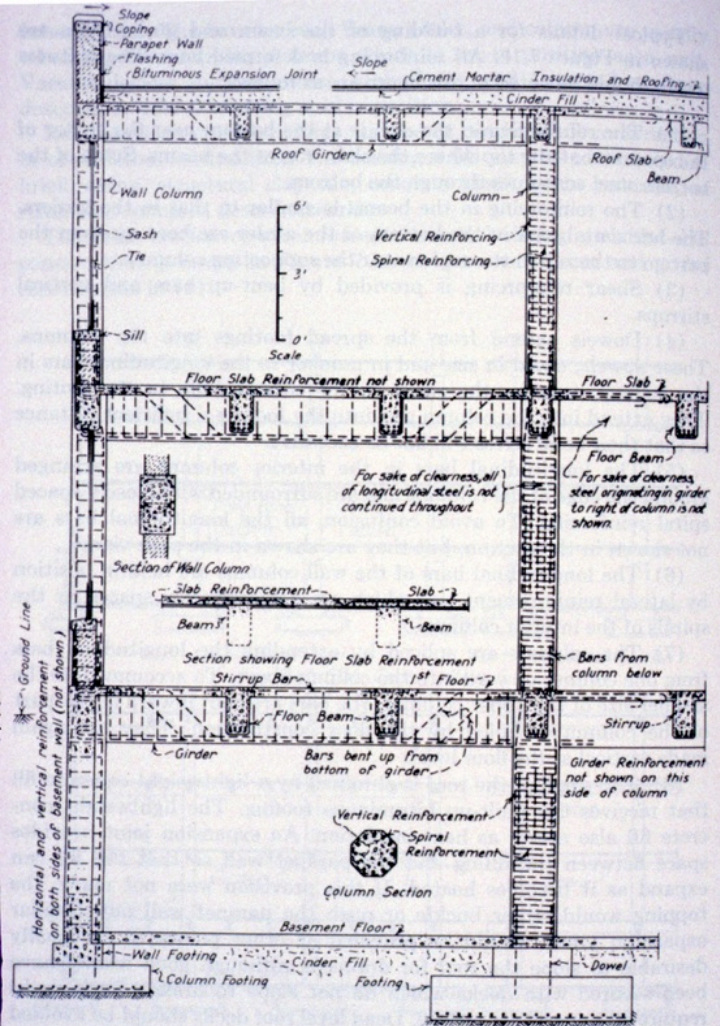

FIGURE 7.13 Beam and girder construction.

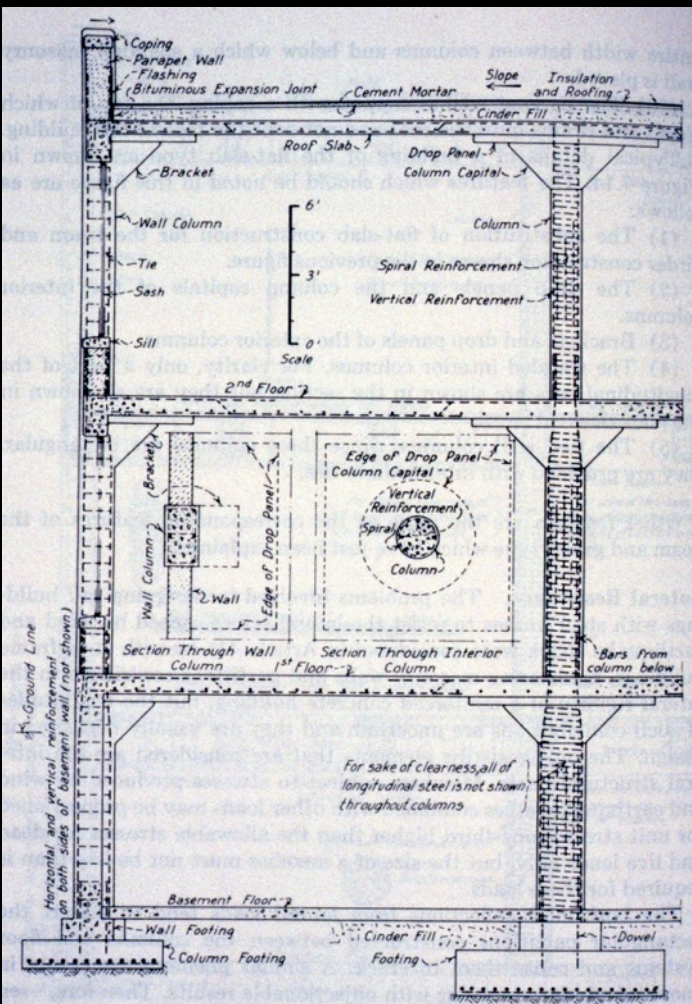
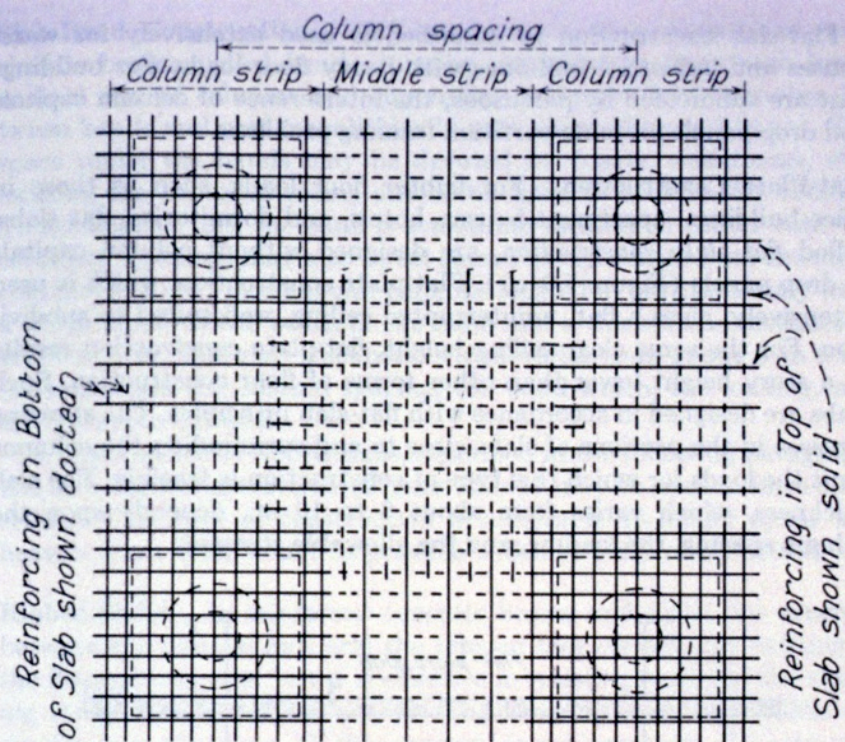

FIGURE 7.14 Flat-slab construction.









(a) Arrangement of reinforcement

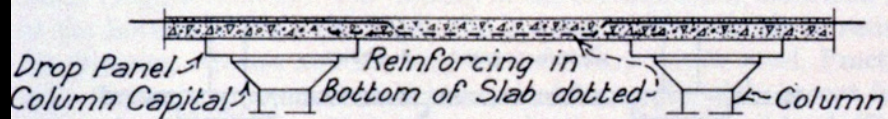

(b) Section through middle strip

FIGURE 7.8 Two-way flat-slab construction.













THERMAL-BONDED POLYMER OUTER LAYER

THERMAL-BONDED GALVANIZED INNER LAYER

CONVENTIONAL REINFORCING STEEL

**100**  
YEARS  
Lab-Tested  
Estimated Life  
Expectancy

MEMBER OF  
**CRSI**





Admixtures are materials other than cement, aggregate and water, that are added to the concrete to alter its properties:

- Workability
- Air entraining
- Curing temperatures range
- Time set
- Colour

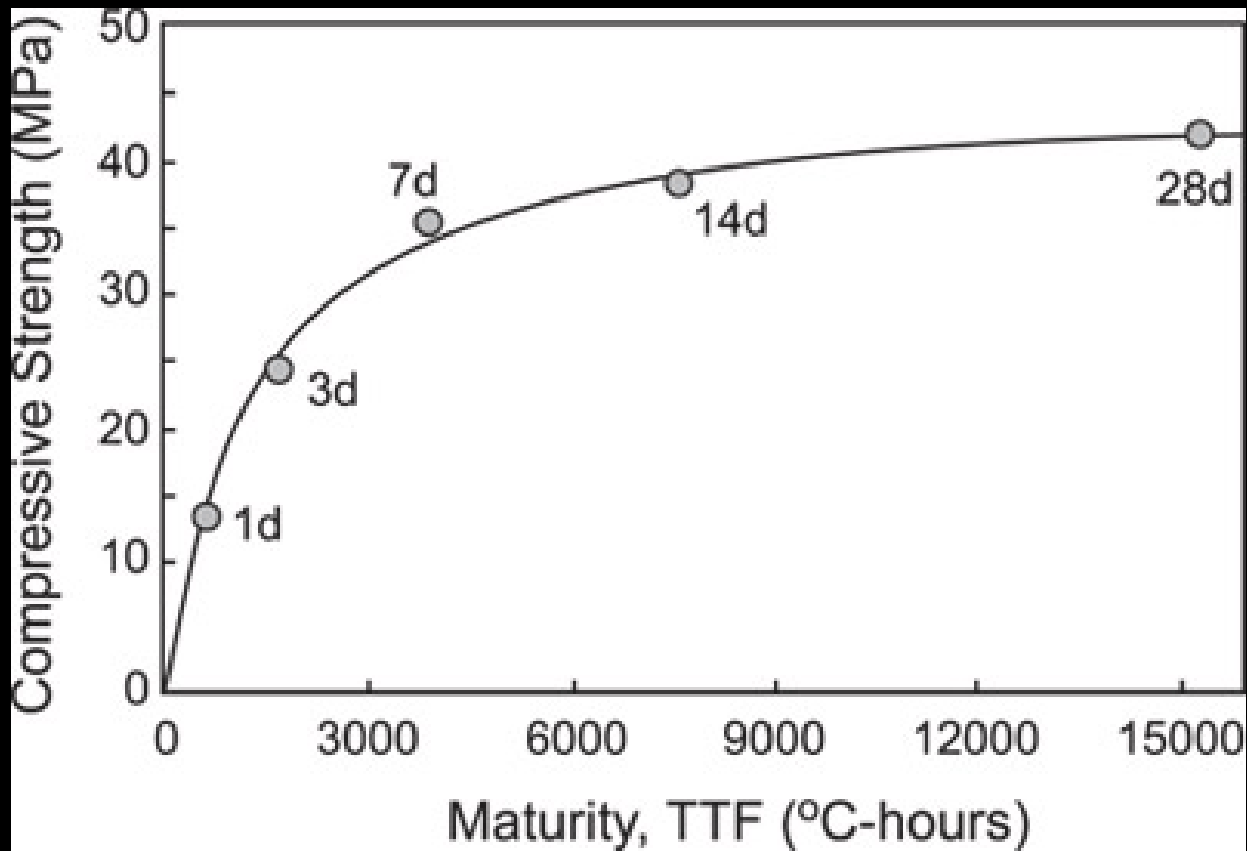

*The compressive strength of concrete improves over time*





The slump test measures the workability/moisture content of the concrete



Cylinder Test is done to verify the strength of the concrete – but after it has reached its 28 day full strength.







The hardened cylinder samples are put in a test machine and crushed to the point of breaking

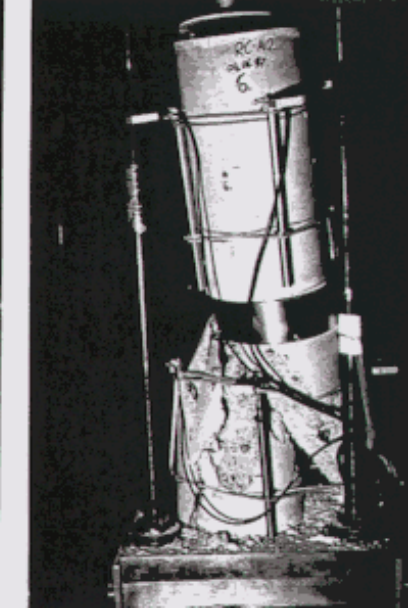
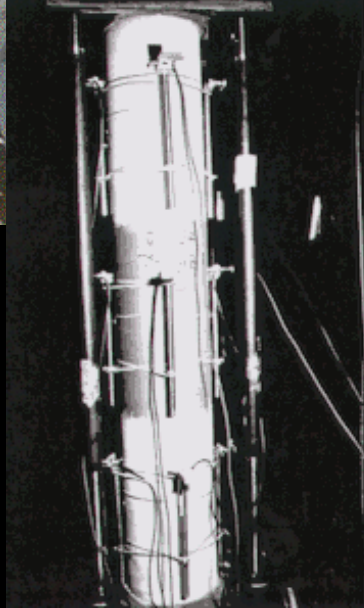

## Concrete CREEP

Concrete continues to "cure" forever. Though its strengthening drops off to nil, it continues to SHRINK over time.

This means buildings get shorter over time.

Must detail for differential shrinkage with cladding materials.



The need for and design of  
**FORMWORK** is a unique aspect  
of concrete construction.

Impacts the time to construct  
and cost of the project.

# Form Tie System (Wall Forming Fastener)

**FT-07  $\phi$  3/8"**

Tie Bolt, Nut, Cone-P, Separator, Rubber Washer

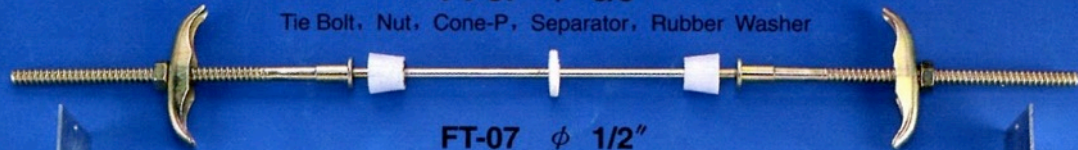

**FT-07  $\phi$  1/2"**

Tie Bolt, Nut, Cone-P, Separator, Rubber Washer



Wing Nuts, Water Stop (WS-68)



Wing Nuts, Cone-S

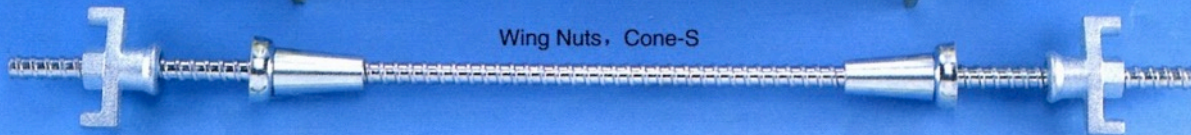

Wing Nuts, Cone-H

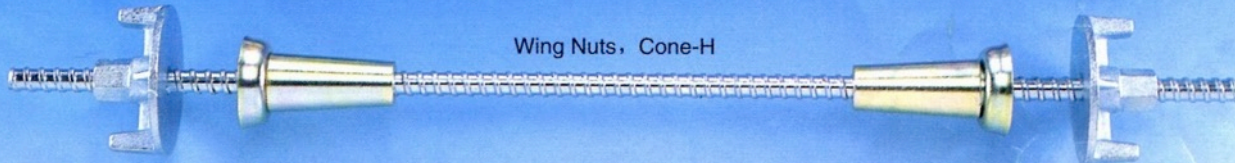











Insulated concrete forms for cold weather pouring at  
Skydome (Rogers Centre) Toronto



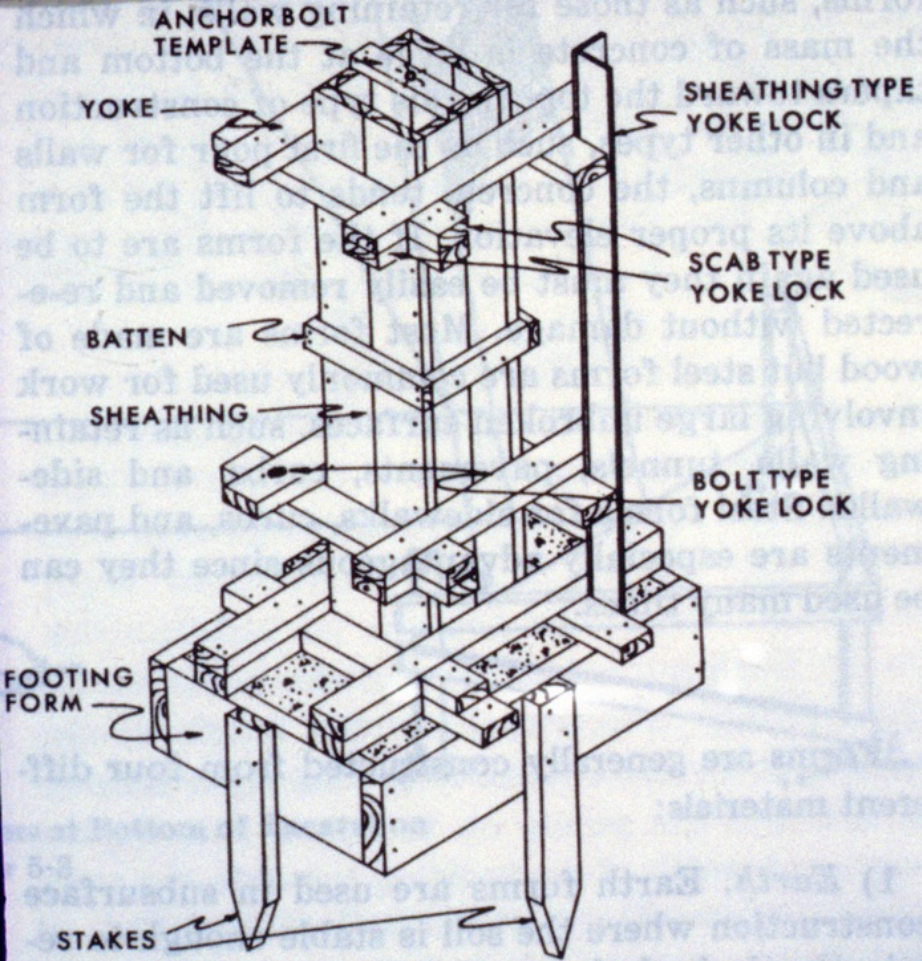

Form for a concrete column  
Figure 6-2

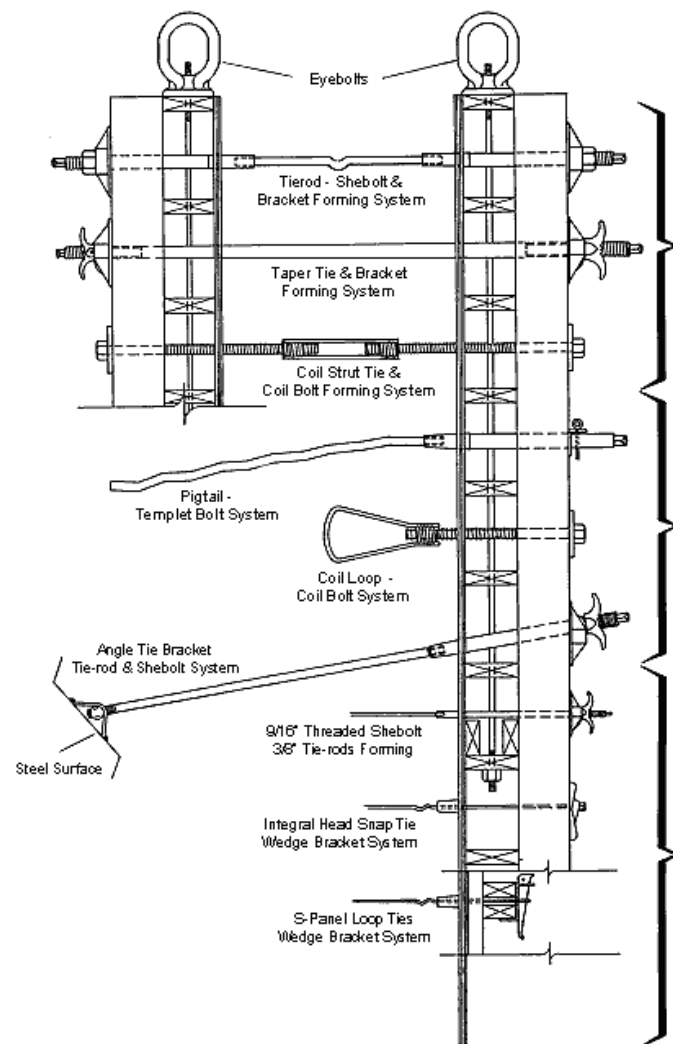



# ***Fast & Simple Framing Around Columns and Walls.***

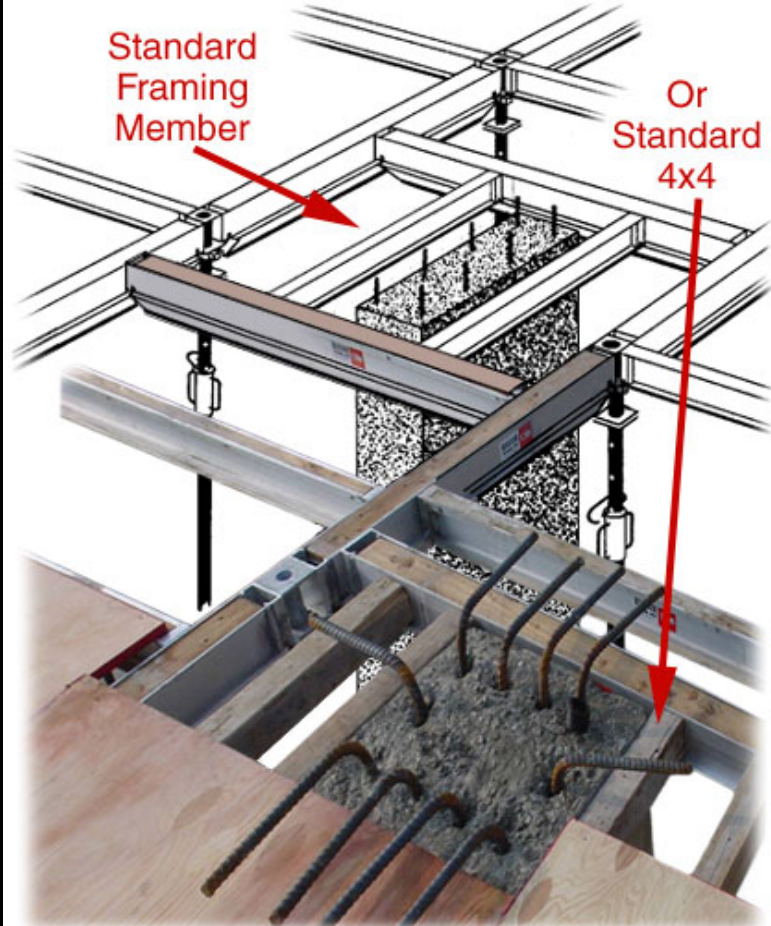

Sonotube forms





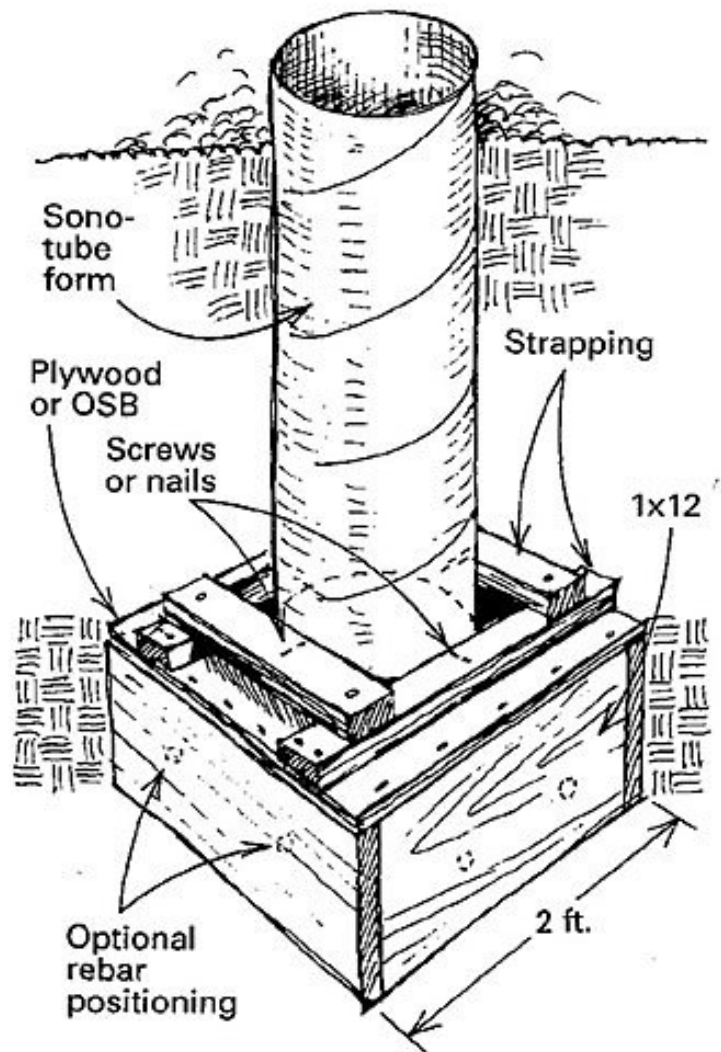

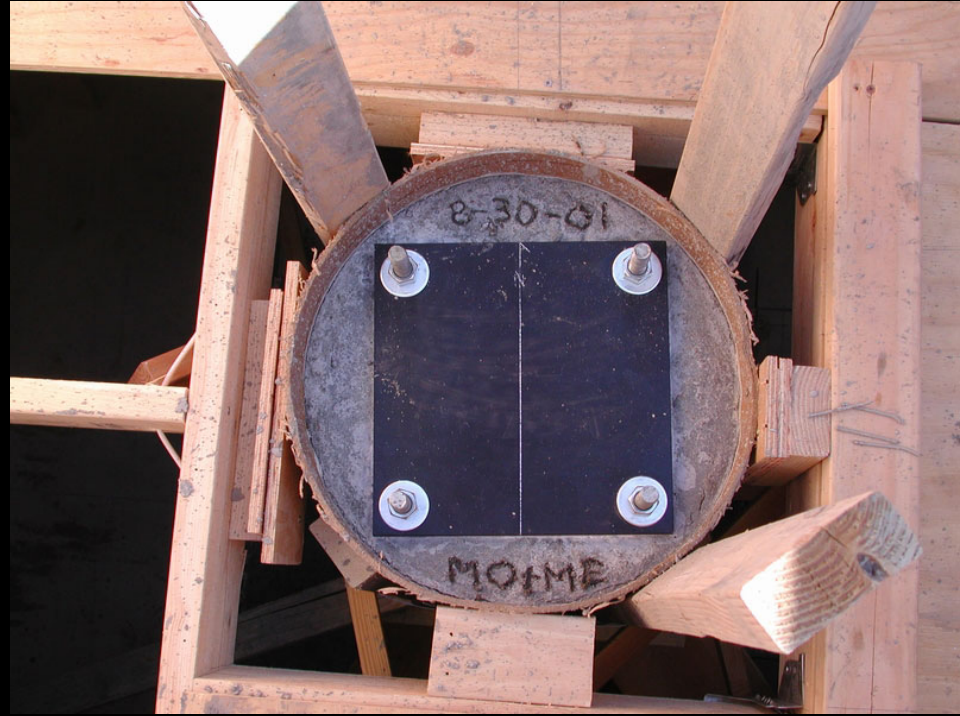
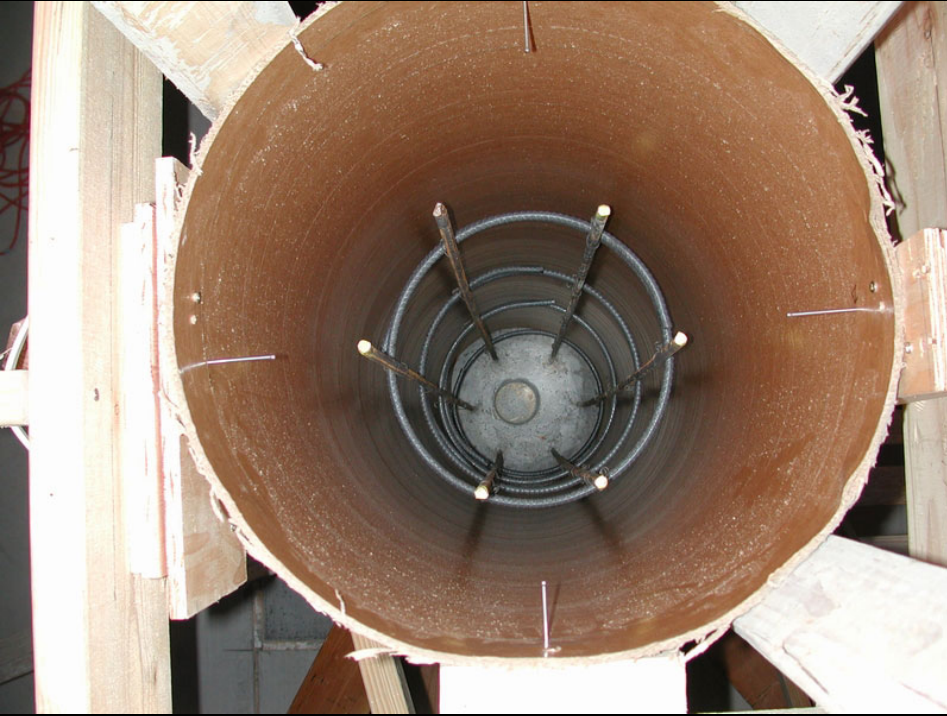



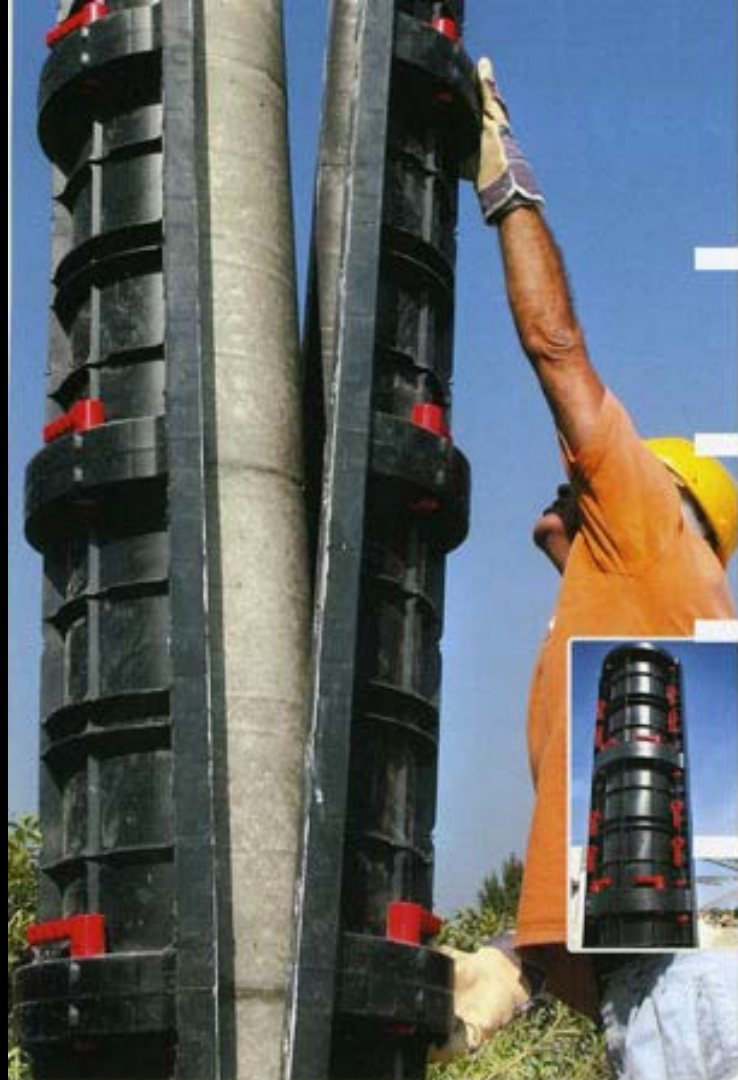





## Reusable Metal Forms

















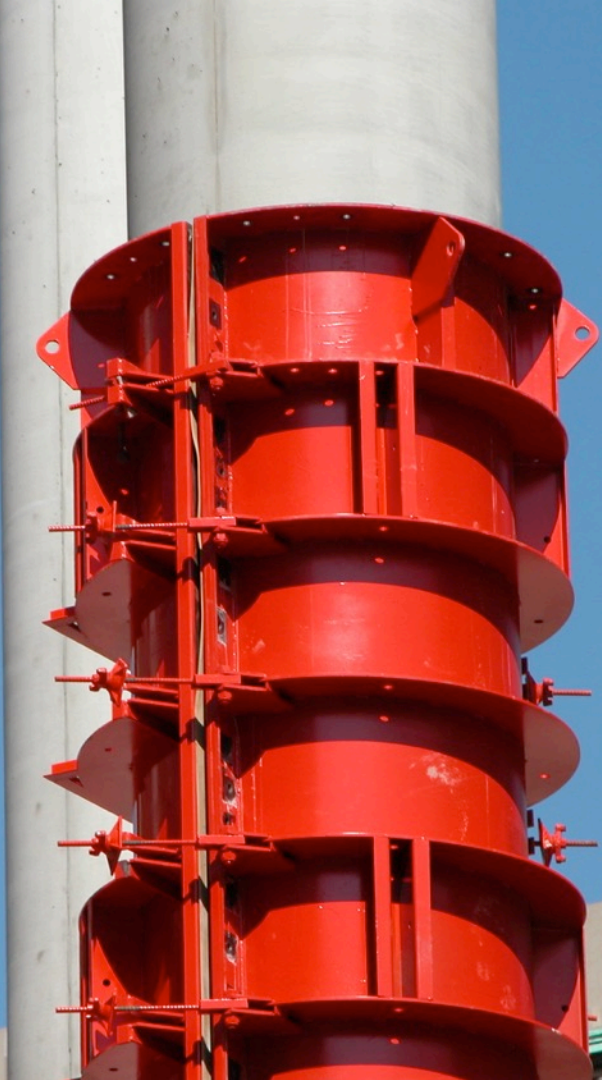









STOP

PROTECTING THE ENVIRONMENT OF ONTARIO  
CONSERVATION

CONS

5M2





**Slip forms**, as this name suggests, is a sliding-form construction method of supporting the pouring of concrete structures. Slip forms are pulled along horizontally or raised vertically as concrete is placed.





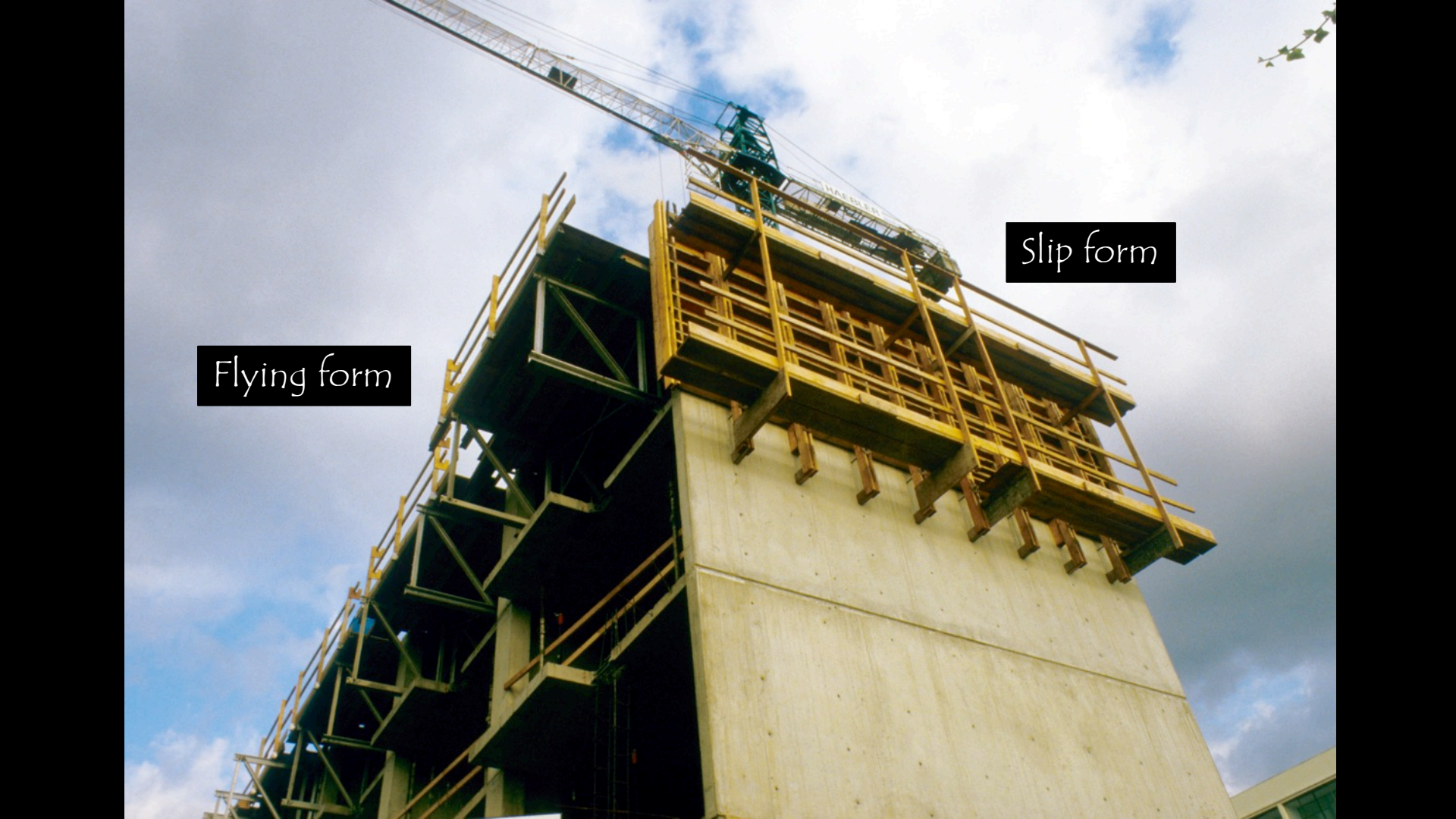

Flying form

Slip form



# Flying forms







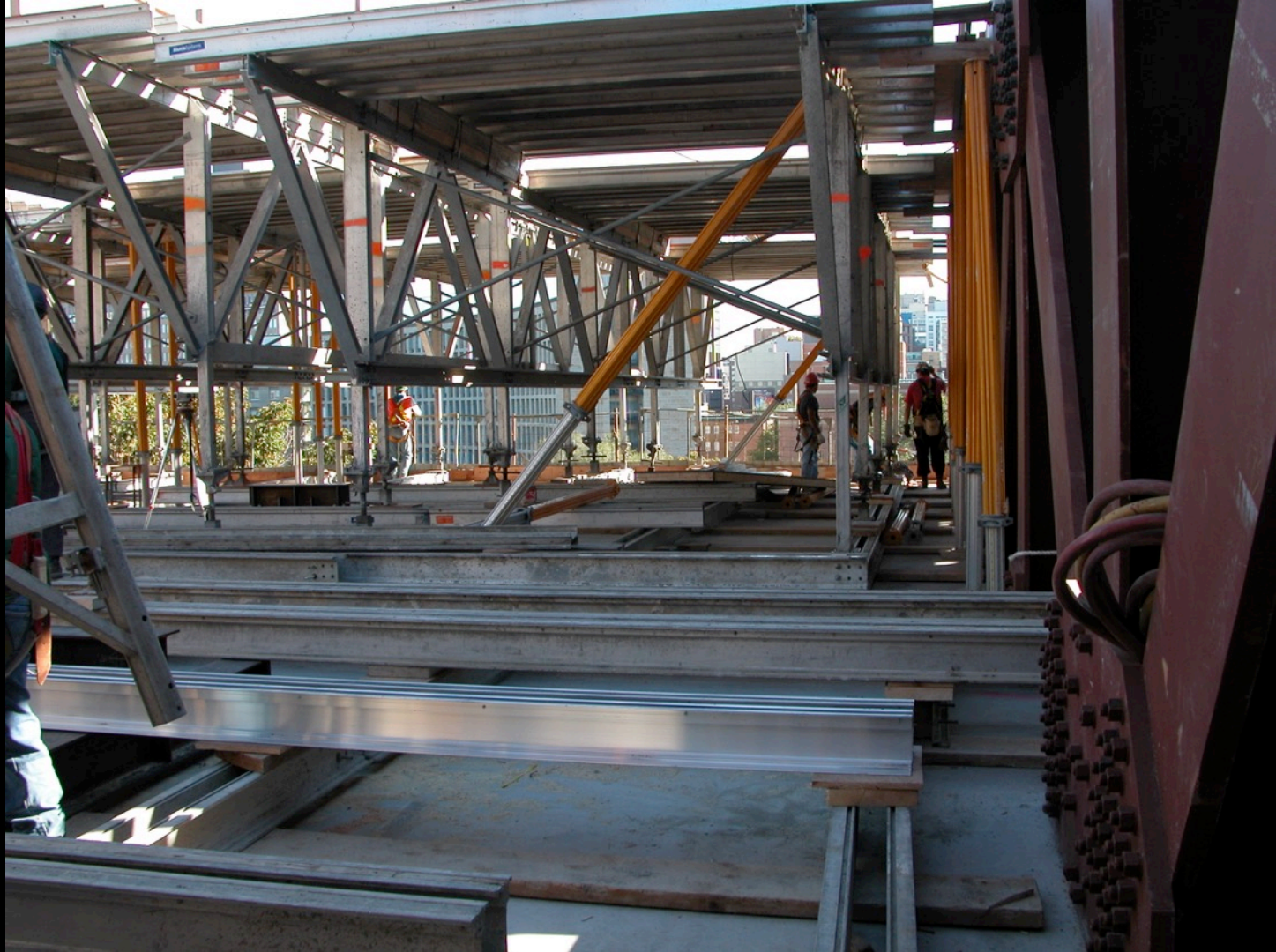









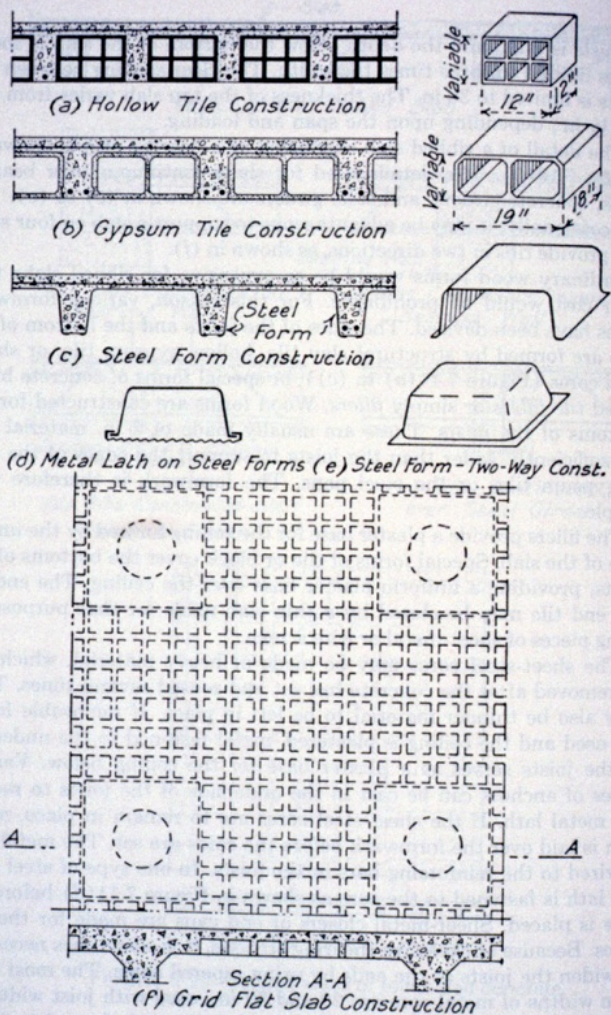

FIGURE 7.11 Cores for ribbed slabs and grid flat-slab construction.

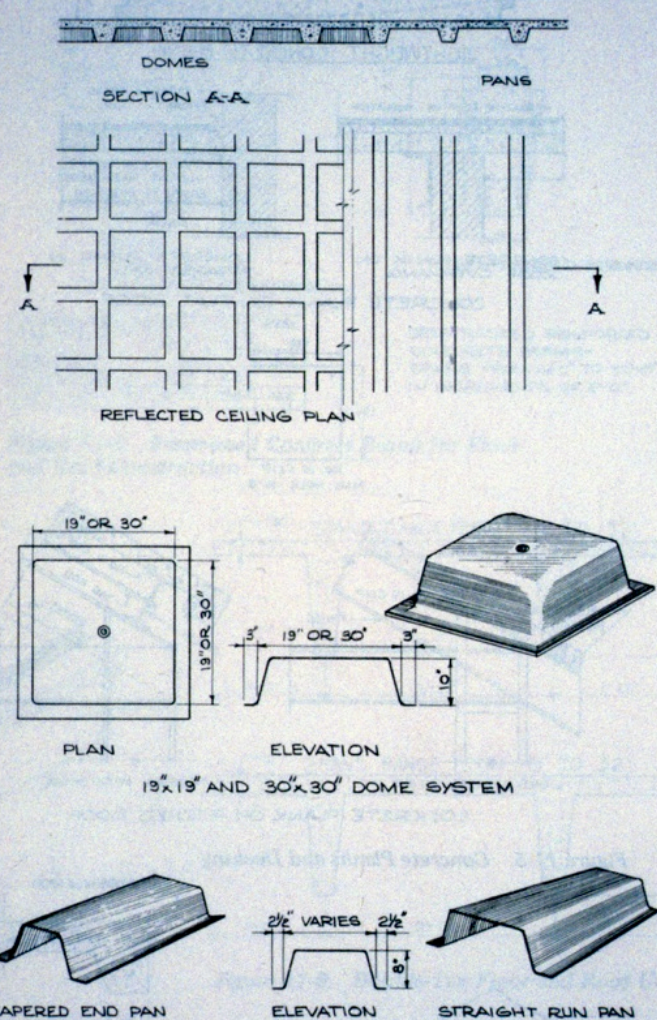
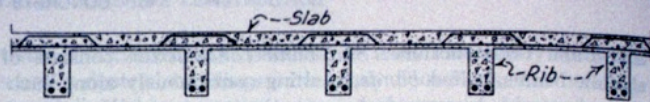
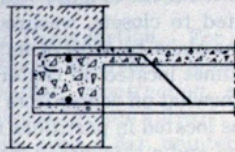

Figure 11-3. Steel Domes and Pans





(a) Concrete Ribbed Slab



(b) Ribs Supported on Bearing Wall

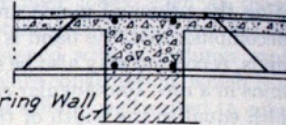

(c) Ribs Continuous over Bearing Wall

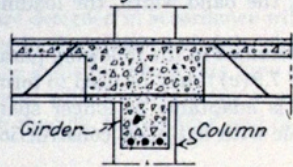

(d) Ribs Continuous over Concrete Girder

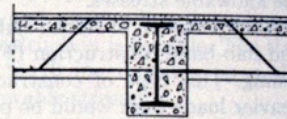

(e) Ribs Continuous over Steel Girder

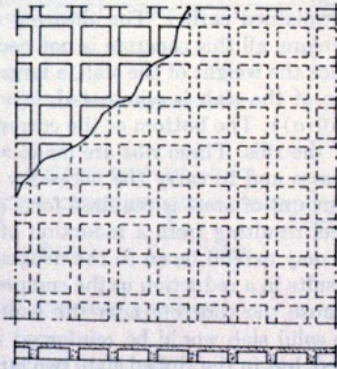

(P) Two-Way Rib Construction

FIGURE 7.10 Ribbed slabs of reinforced concrete.









Exit to D



Exits to Maryland Avenue or 9th and D Streets

THIS EXIT IS CLOSED ON SATURDAYS AND SUNDAYS.  
PLEASE USE THE EXIT AT 7th and MARYLAND AVENUE OR 9th AND D STREETS.











**Composite decks** use the combined strength of steel decking, reinforcing and the concrete slab

The steel deck acts as a permanent form as well as adding strength



















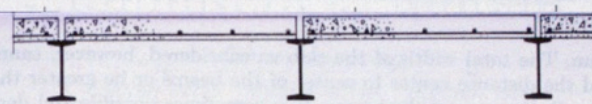

(a) Concrete Slab on Steel Beams

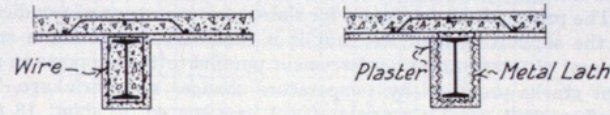

(b) Method for Fireproofing Steel Beams with Concrete

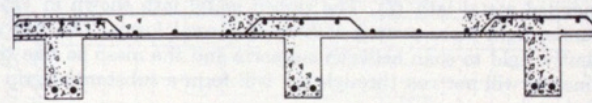

(c) Concrete Slab on Concrete Beams

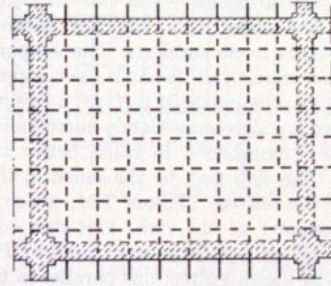

(d) Slab on Beams or Bearing Wall  
 Beam or Bearing Wall  
 Column

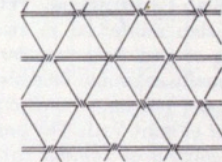

Triangle Mesh

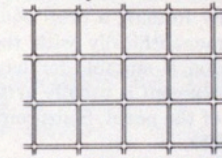

Clinton Electric Welded Wire Mesh

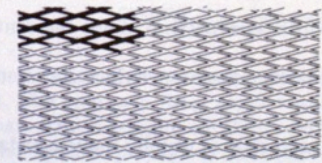

(f) Expanded Metal

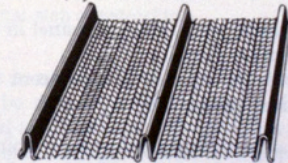

(g) Ribbed Metal Lath

FIGURE 7.7 Reinforced concrete slabs.

Shear walls are solid concrete walls that are placed perpendicular to the long dimension of the building to make the rectangular form stiffer to resist collapse



*Shear walls continuous to foundation  
Openings through walls are required*

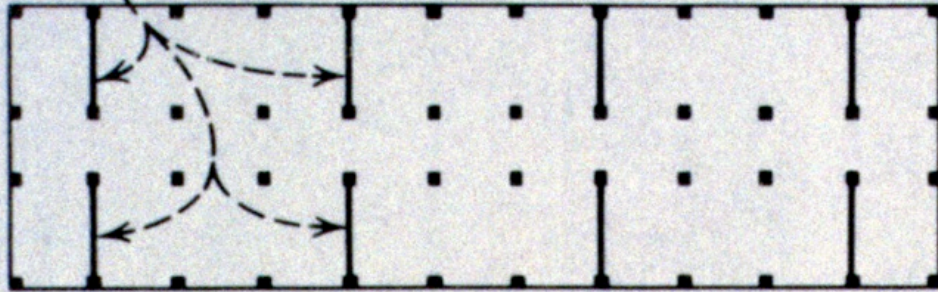

*(a) Transverse shear walls*

Wind direction

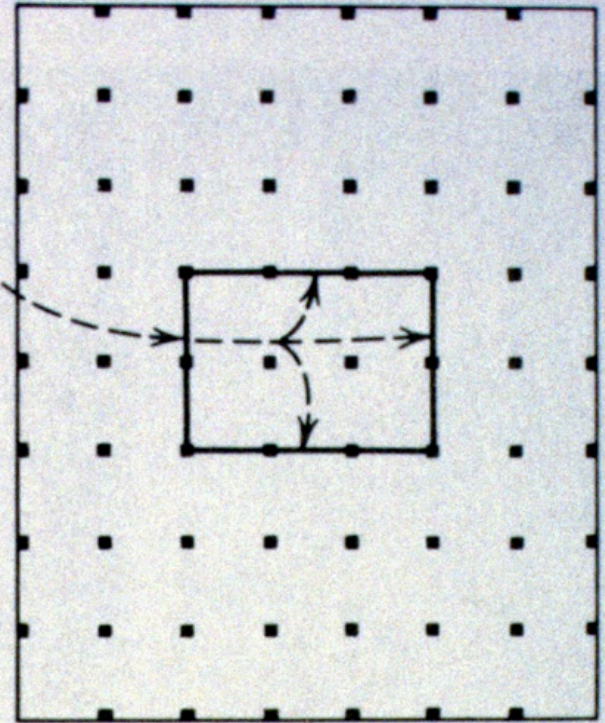

*(b) Shear walls  
around central core*

FIGURE 7.16 Shear walls.

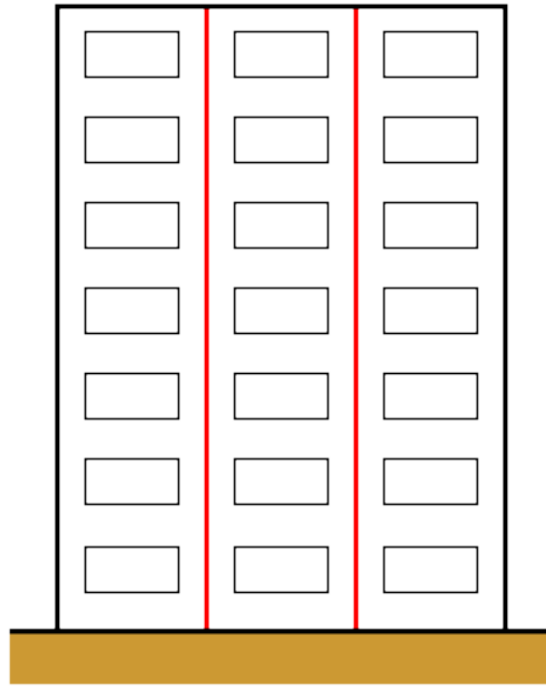

Elevation

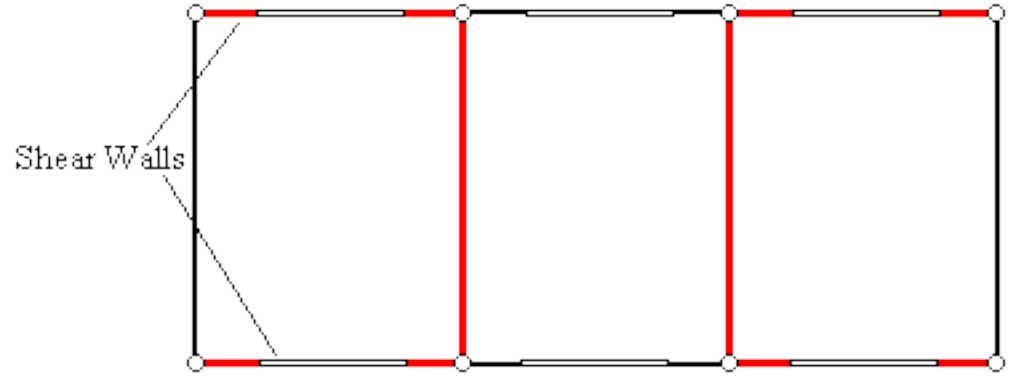

Plan

Wind direction



Fig 2. Typical arrangement of shear walls



Thin shell roofs get their strength from the geometry of their shape or cross section

–

Material is moved away from the centre of gravity of the section

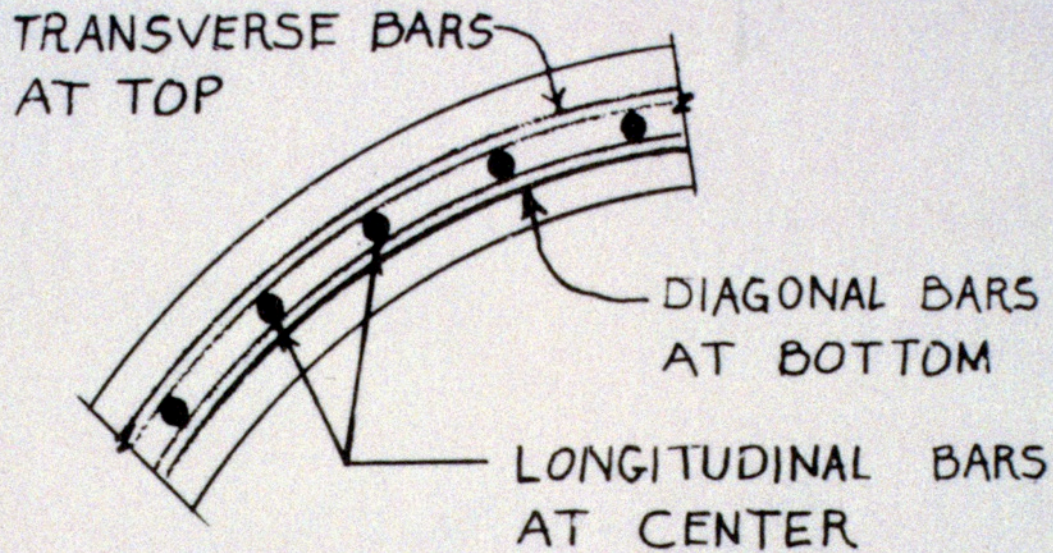

*Figure 11-16. Placement  
of Reinforcing Bars in  
Thin Shell*









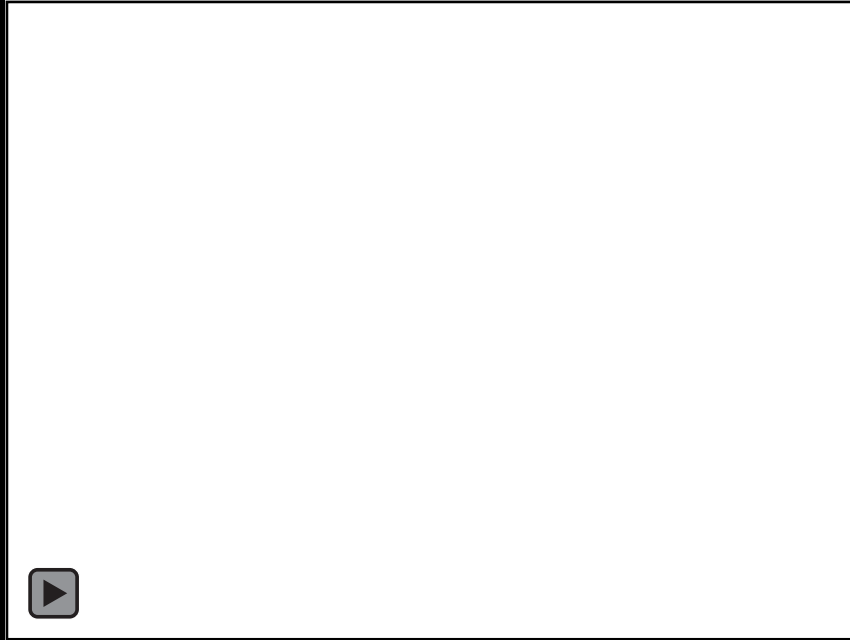

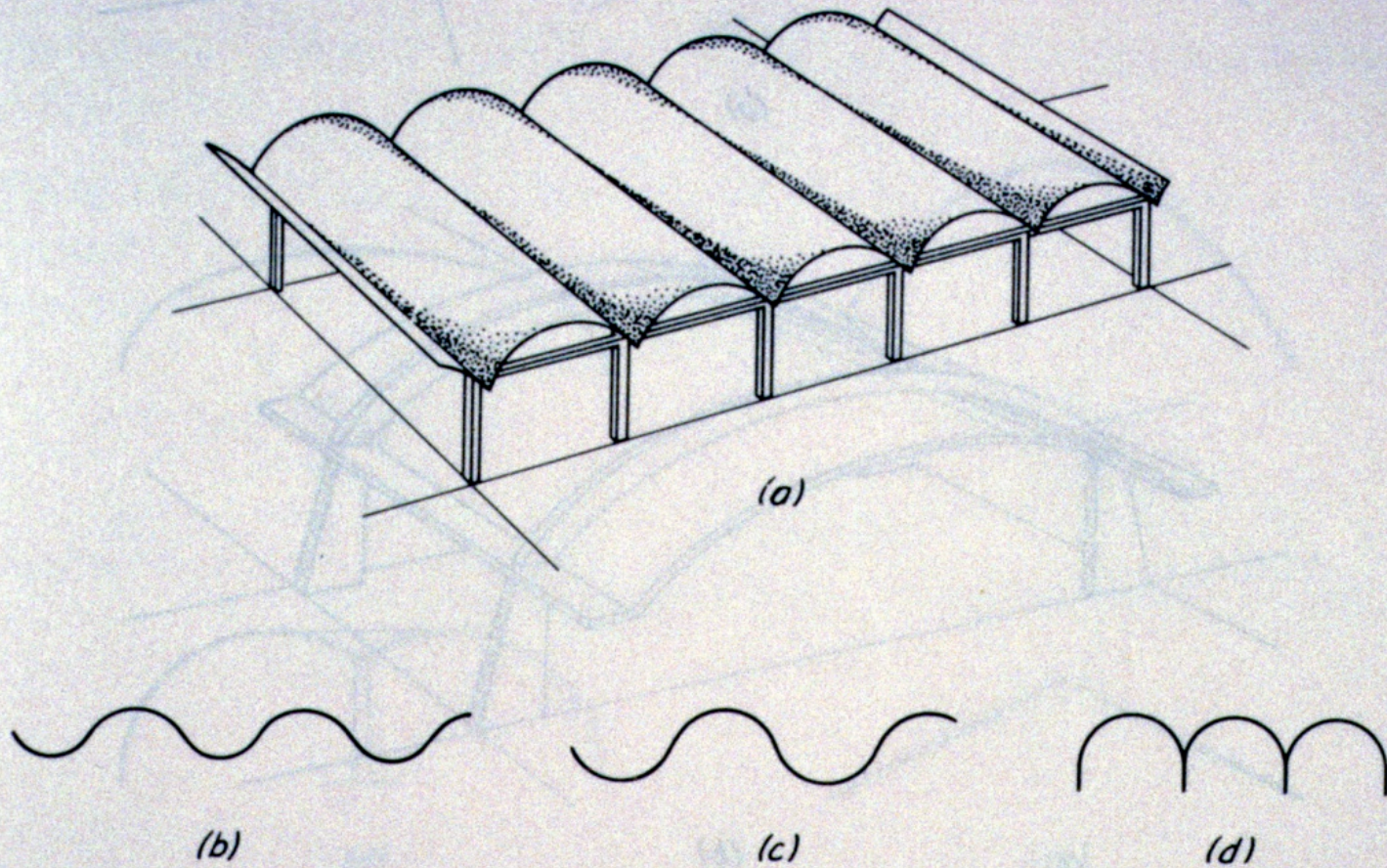
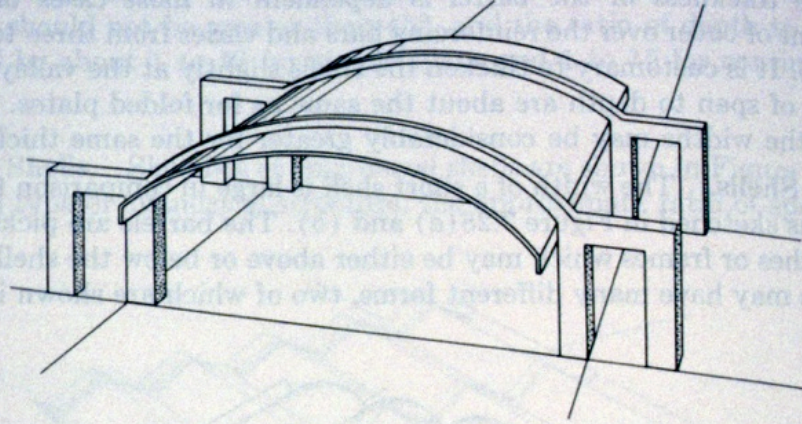
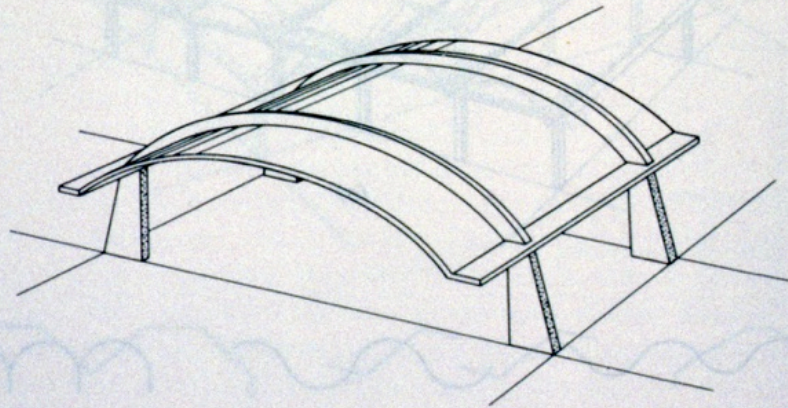

FIGURE 7.25 Long-barrel shell roof.





(a)



(b)

FIGURE 7.26 Short-shell roofs.

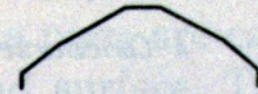
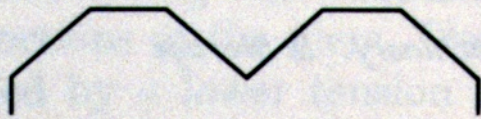
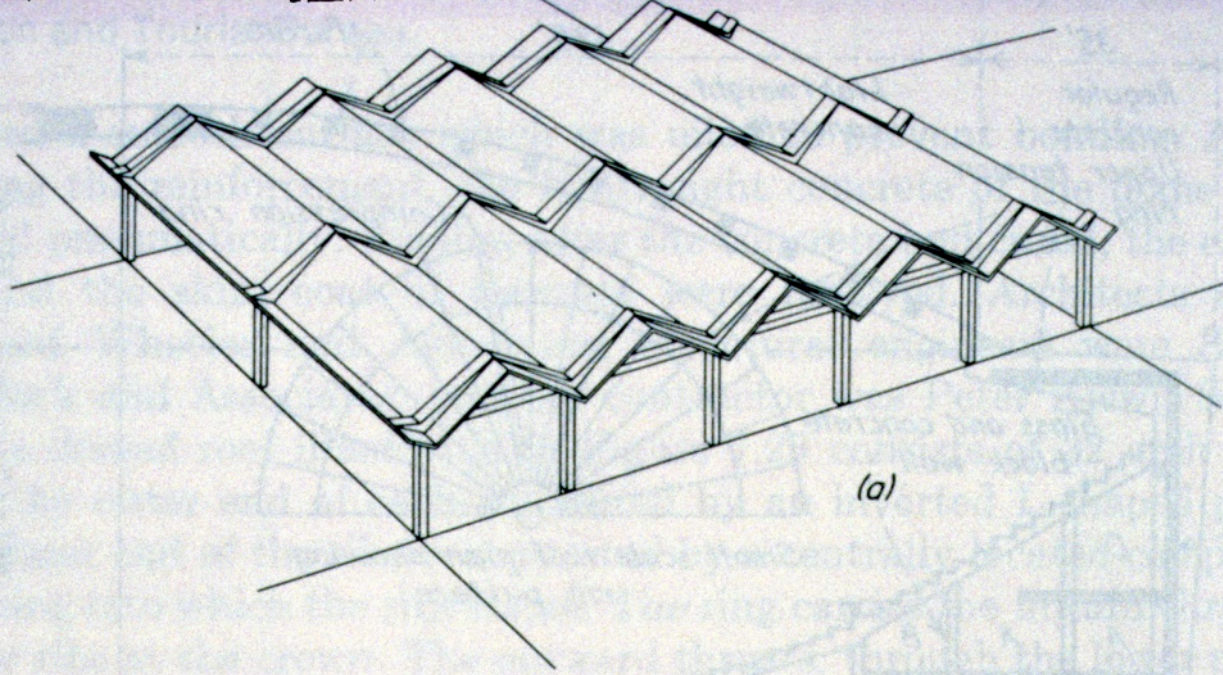

FIGURE 7.24 Folded plate roofs.











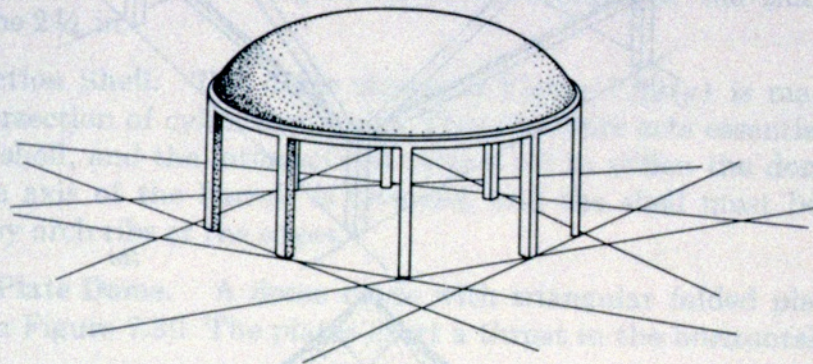

(a)



(b)

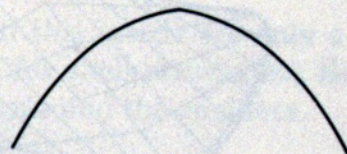

(c)



(d)

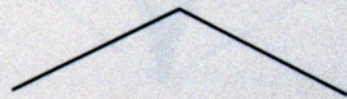

(e)

FIGURE 7.27 Domes of revolution.









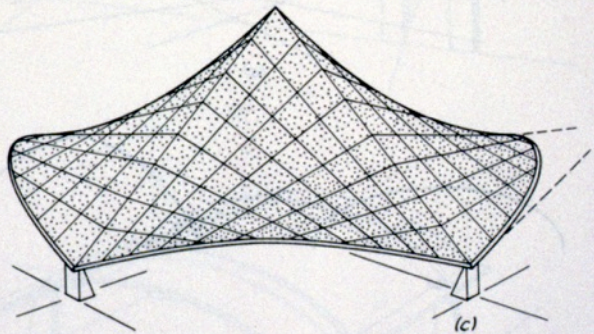
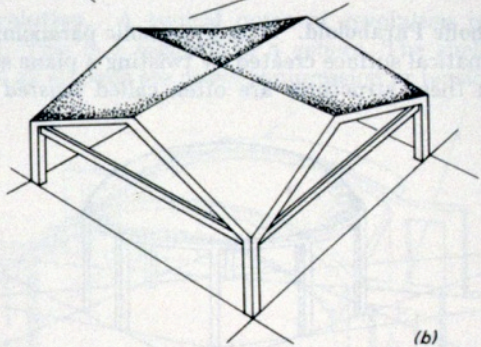
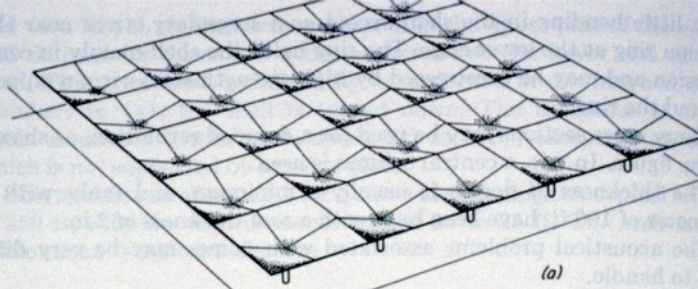

FIGURE 7.28 Hyperbolic paraboloid roofs.







the details of construction practice





























Expansion joint



28 day closure strip



Expansion joint













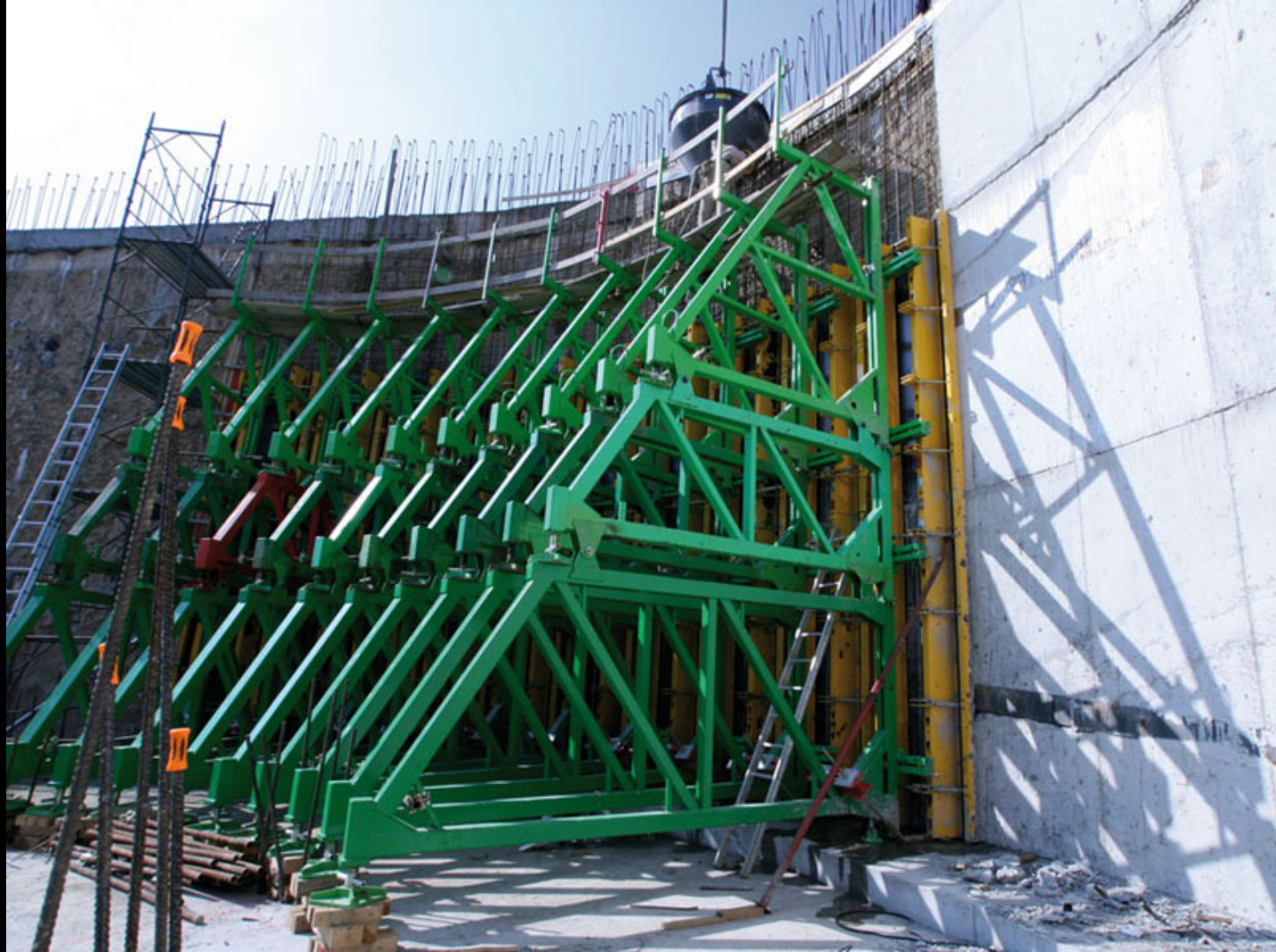













O-14 Tower,  
Dubai



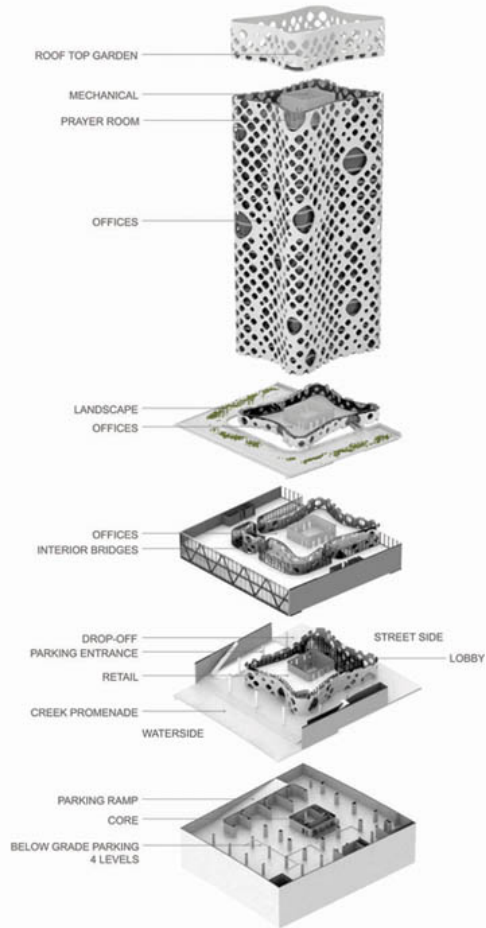

TOWER ISOMETRIC

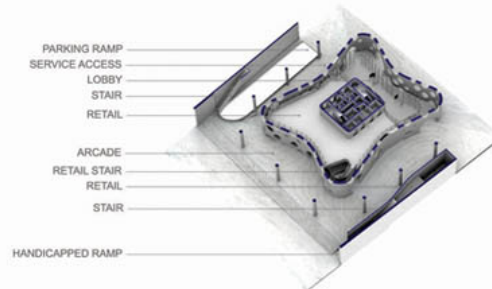
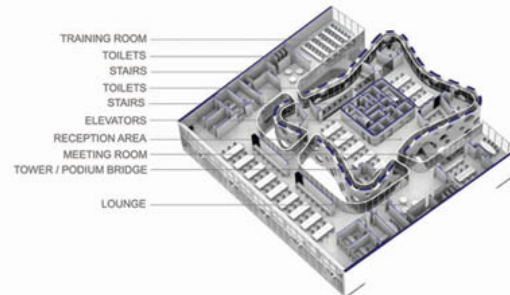
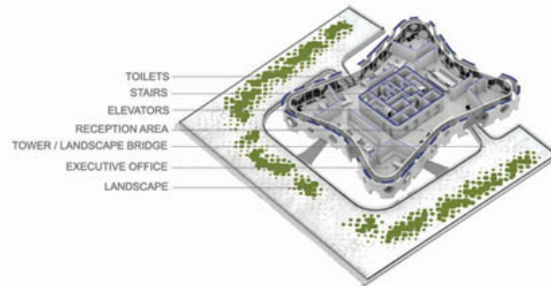

PODIUM ISOMETRIC





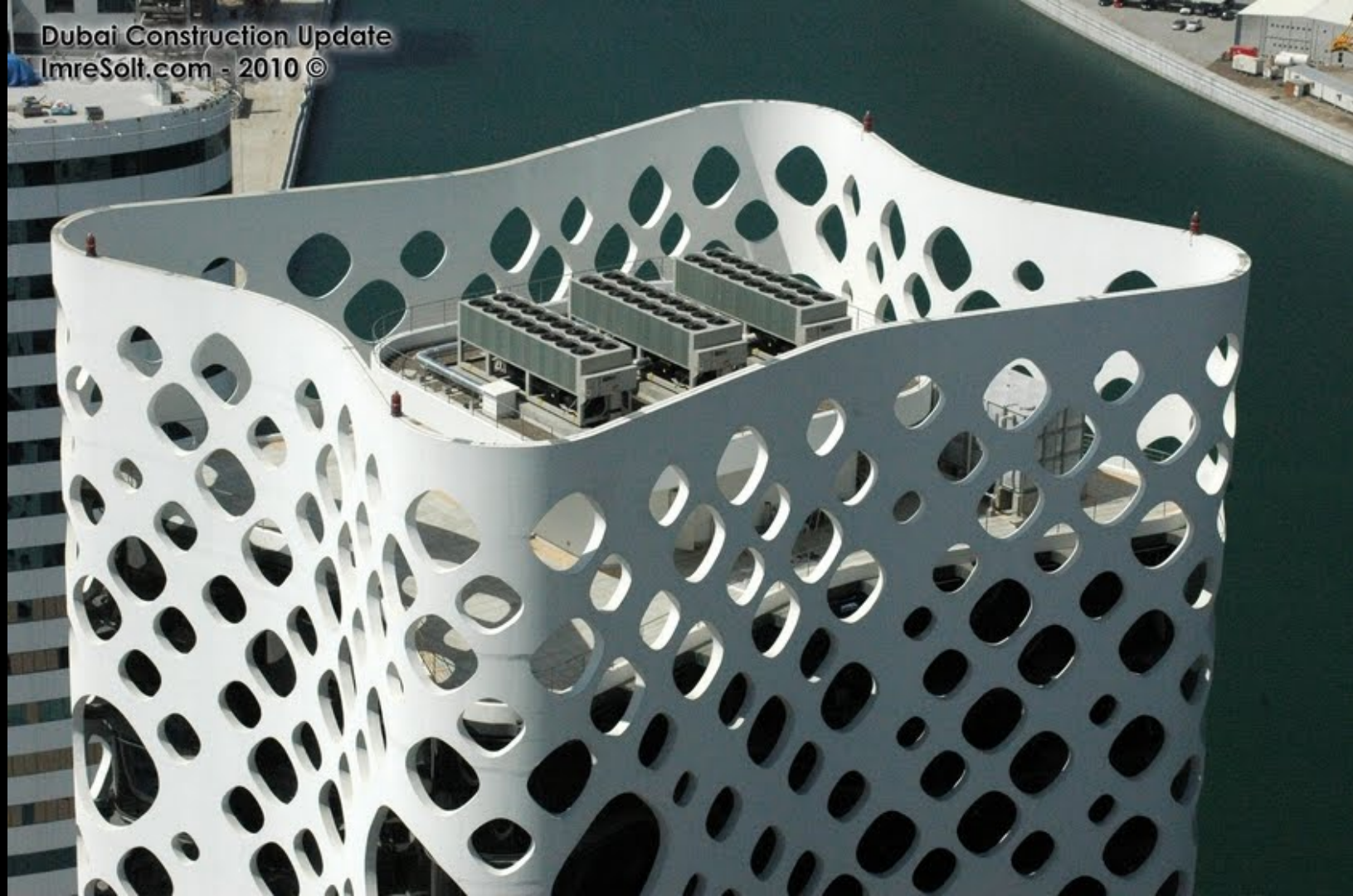



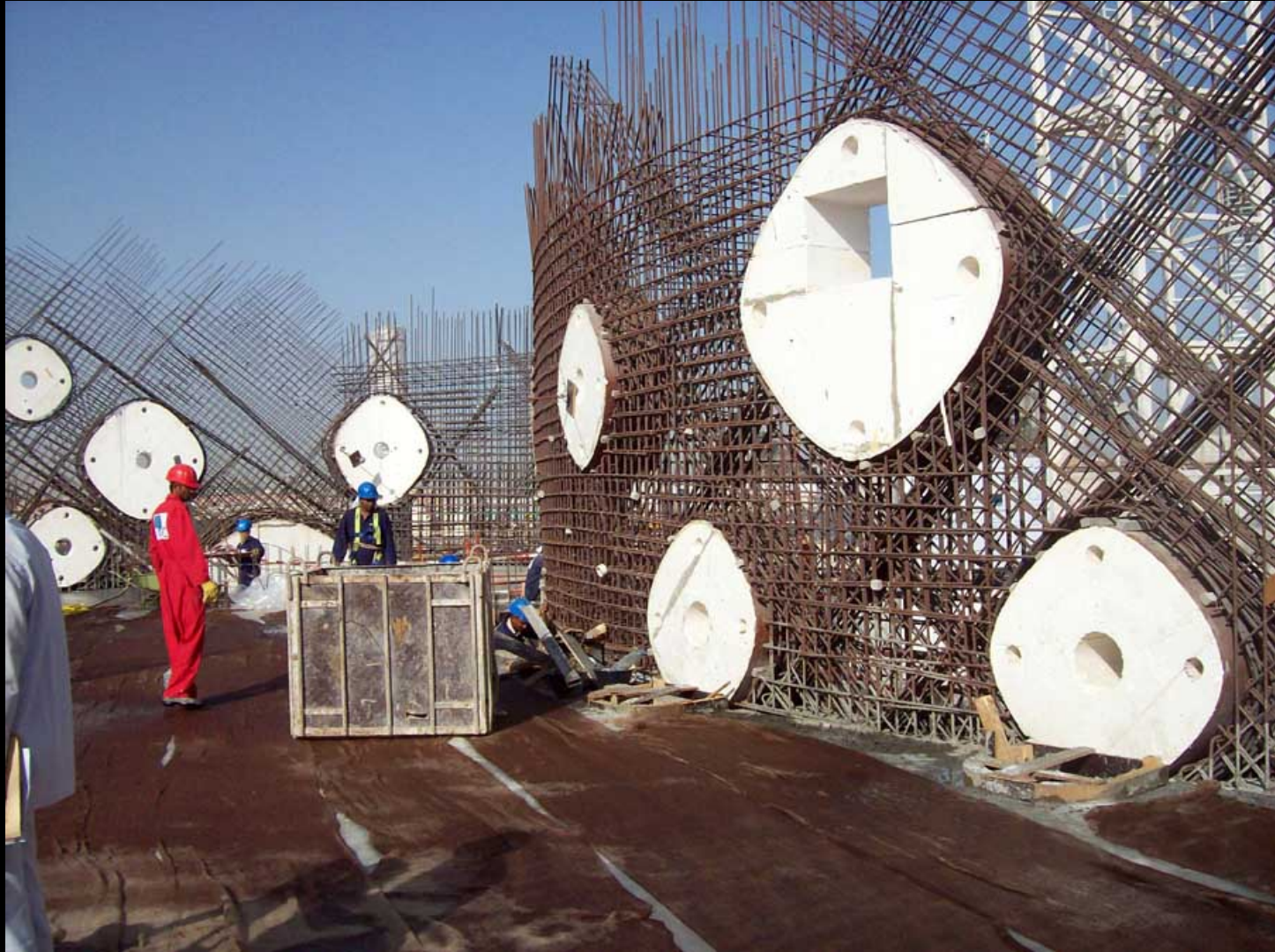















Makomanai Takino Cemetery  
Sapporo, Japan  
Tadao Ando  
2017





足元  
注意

足元  
注意

























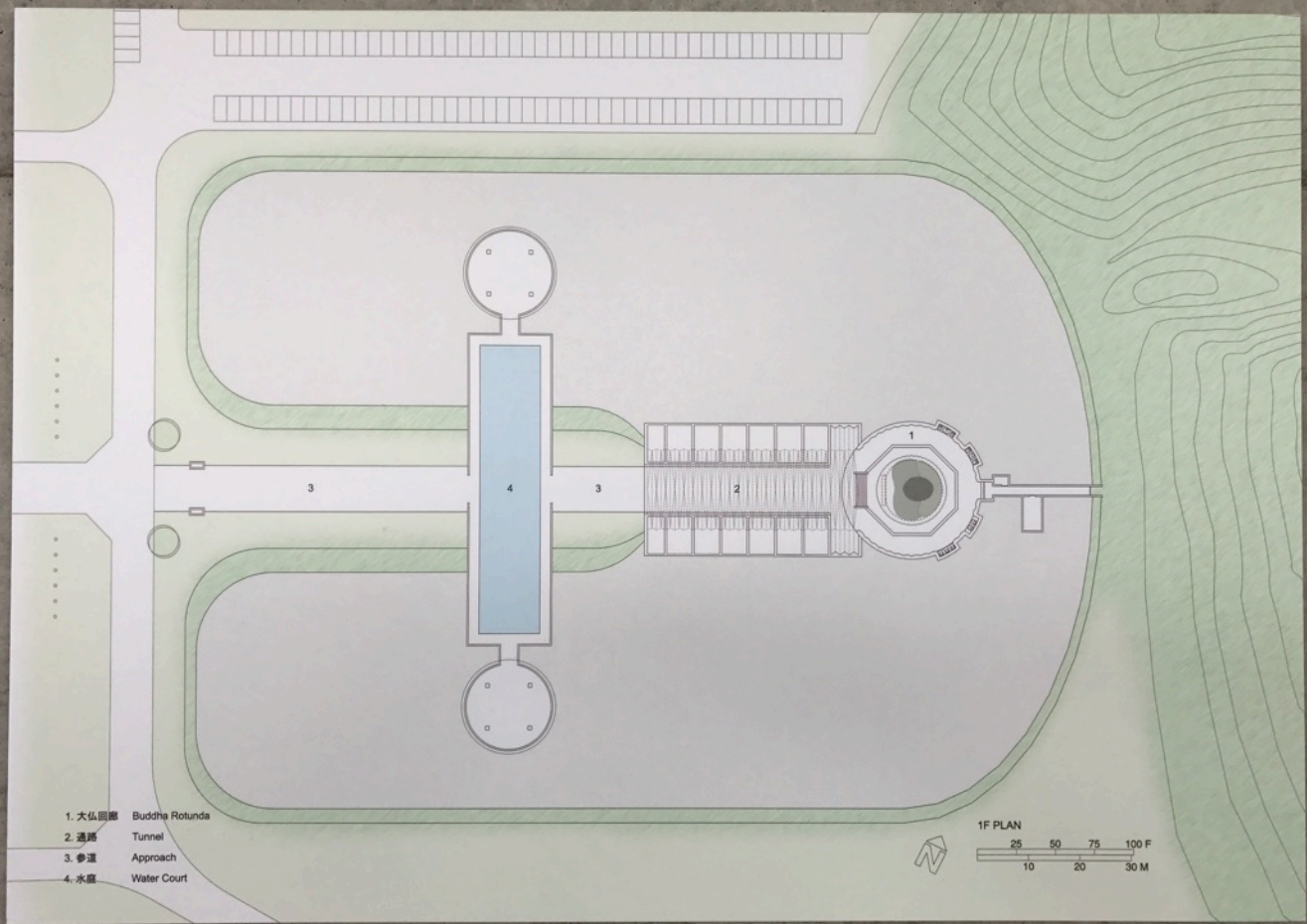

- 1. 大仏圓廊 Buddha Rotunda
- 2. 通路 Tunnel
- 3. 參道 Approach
- 4. 水庭 Water Court

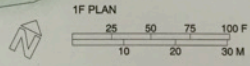





































































Roy Thomson Hall, Toronto  
Arthur Erickson













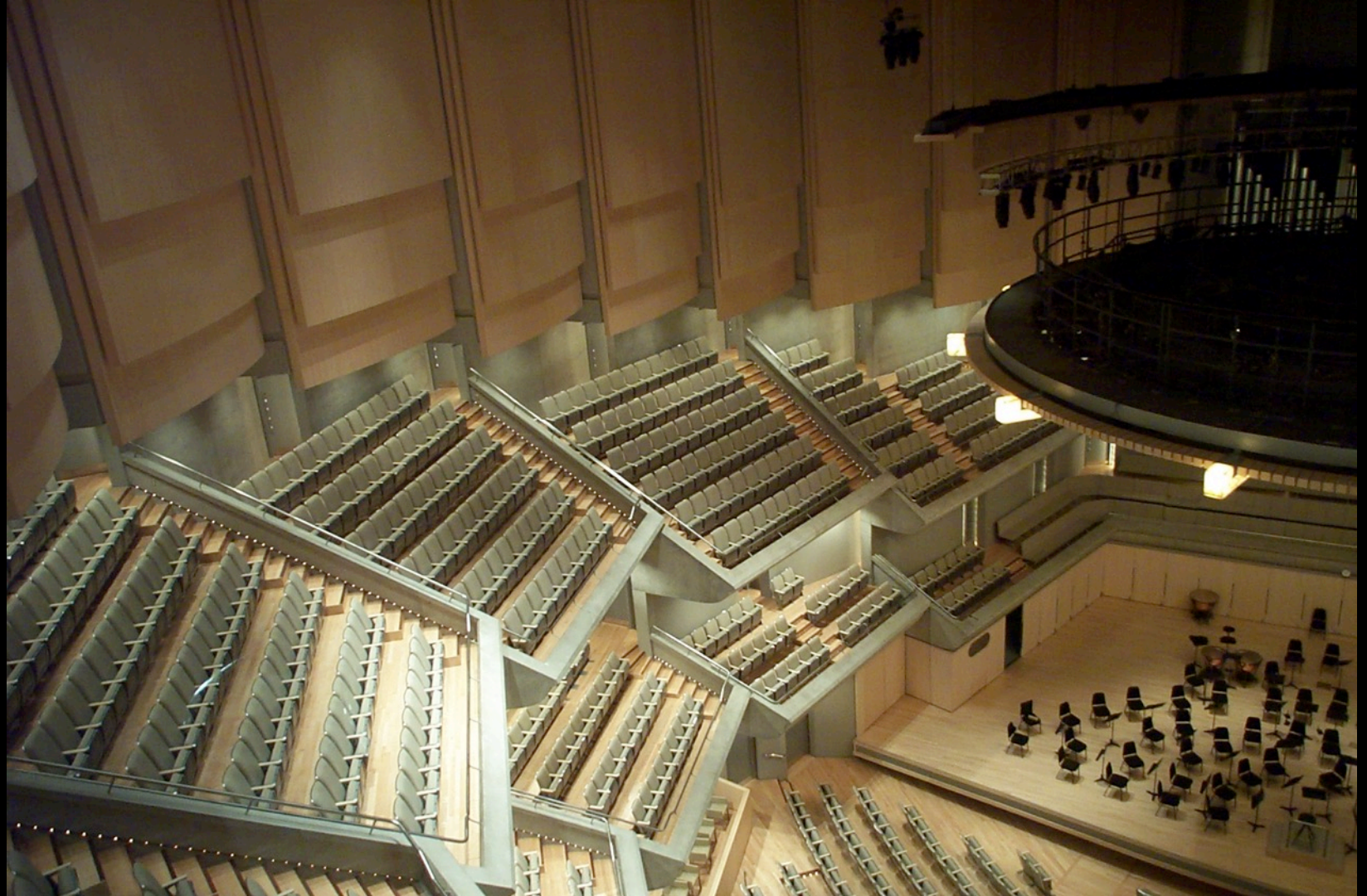



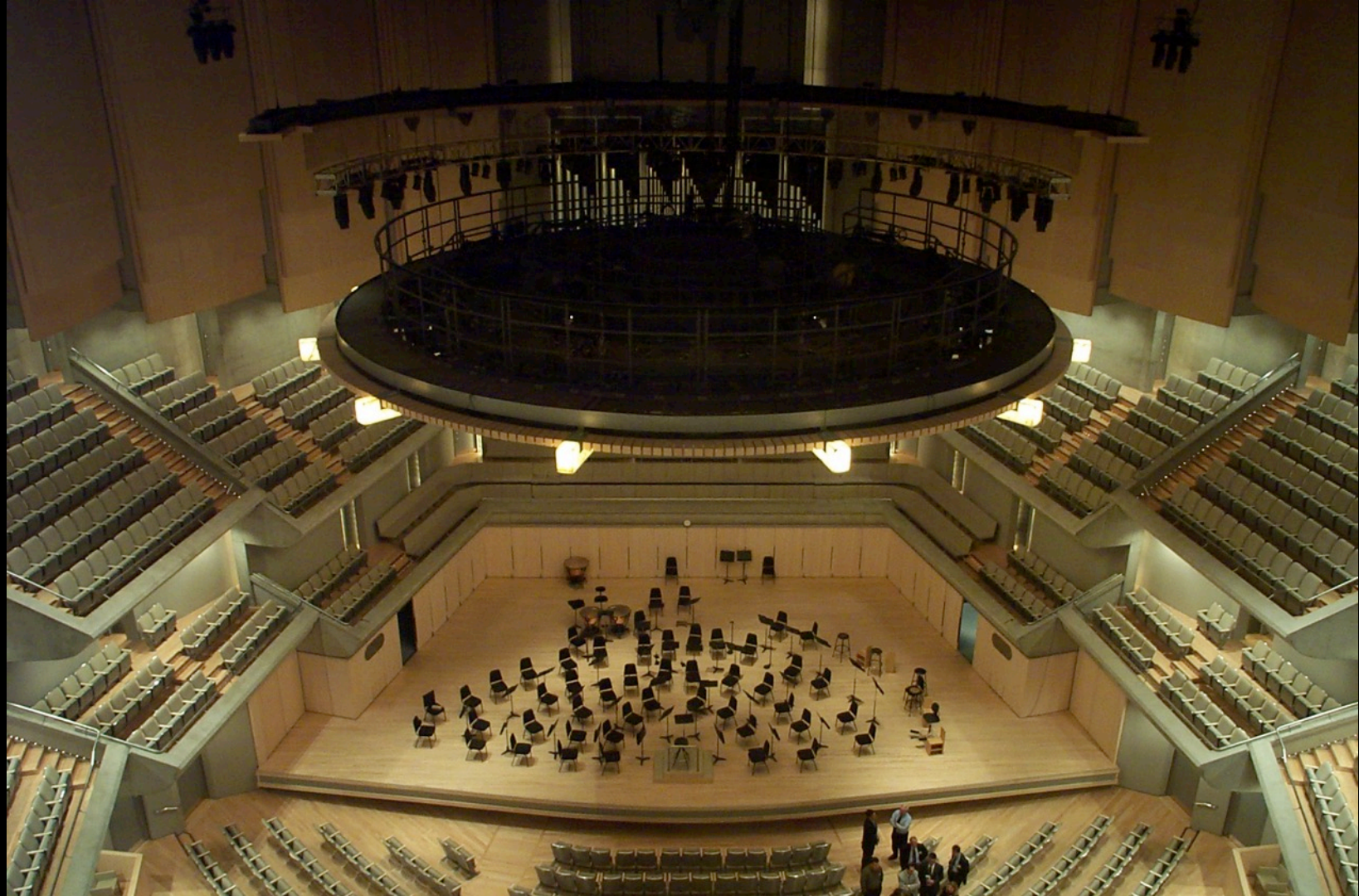











University of Lethbridge, Alberta  
Arthur Erickson





















Information  
Accessibility  
Security  
Health & Safety  
Sustainability  
Governance  
Partnerships  
Community  
Research & Innovation  
Student Experience  
Employment  
Marketing & Communications  
Legal & Compliance  
IT & Digital  
Finance & Operations  
Human Resources  
Facilities Management  
Risk Management  
Quality Assurance  
External Relations  
Corporate Social Responsibility  
Legal & Compliance  
IT & Digital  
Finance & Operations  
Human Resources  
Facilities Management  
Risk Management  
Quality Assurance  
External Relations  
Corporate Social Responsibility

Cafe  
CAFE

Computer Lab

STUDY CENTRE  
STUDY CENTRE







Hyatt Regency Hotel,  
San Francisco









Robson Square, Vancouver





















Law Courts, Vancouver  
Arthur Erickson











































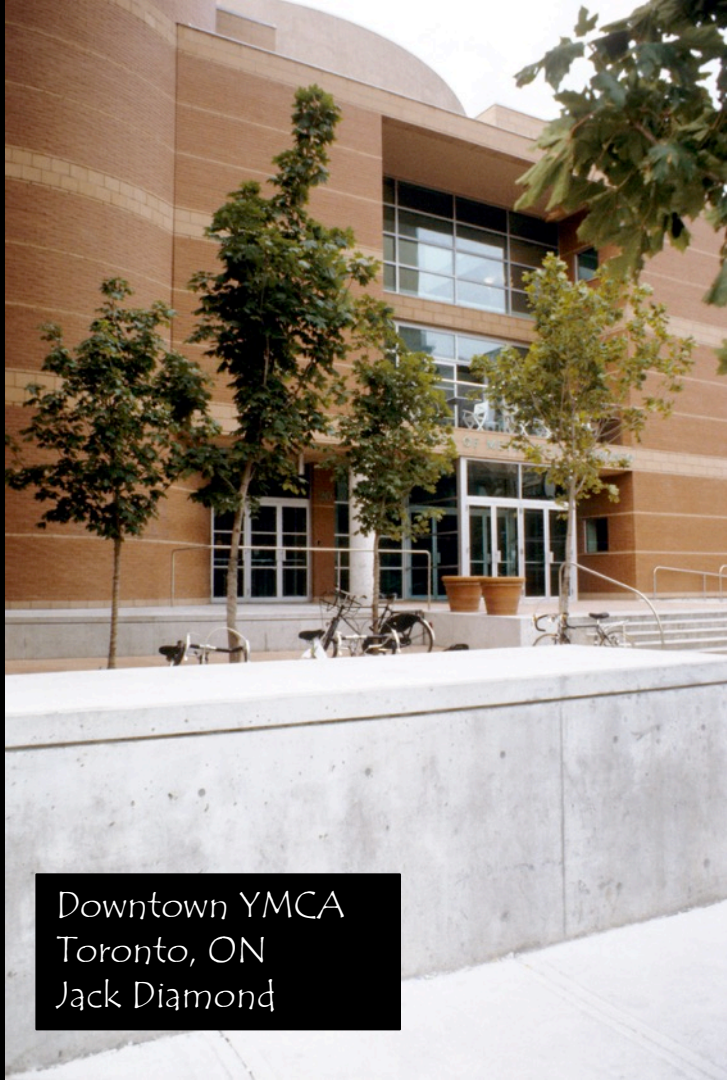

Downtown YMCA  
Toronto, ON  
Jack Diamond























National Gallery  
Ottawa, ON  
Moshe Safdie





















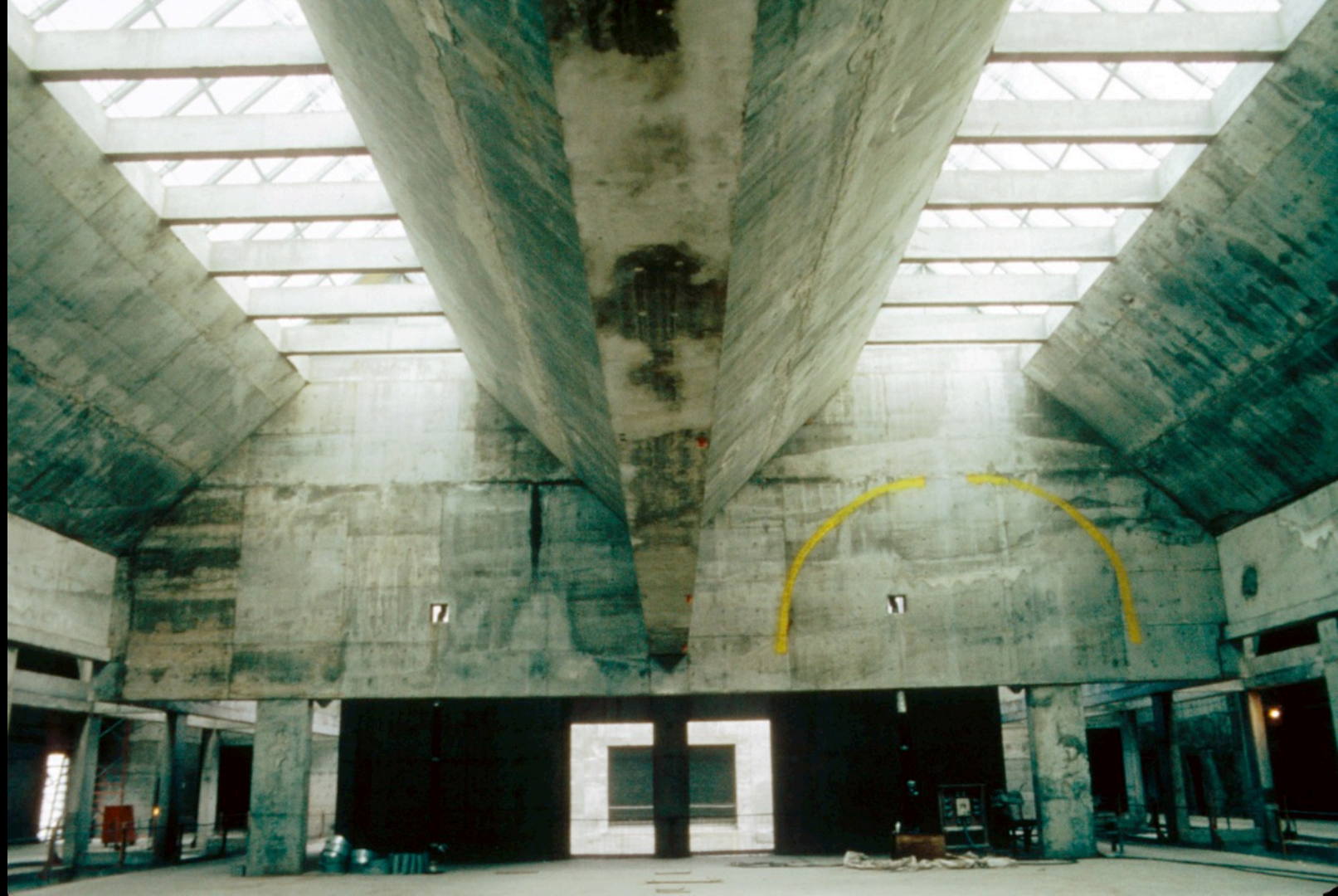









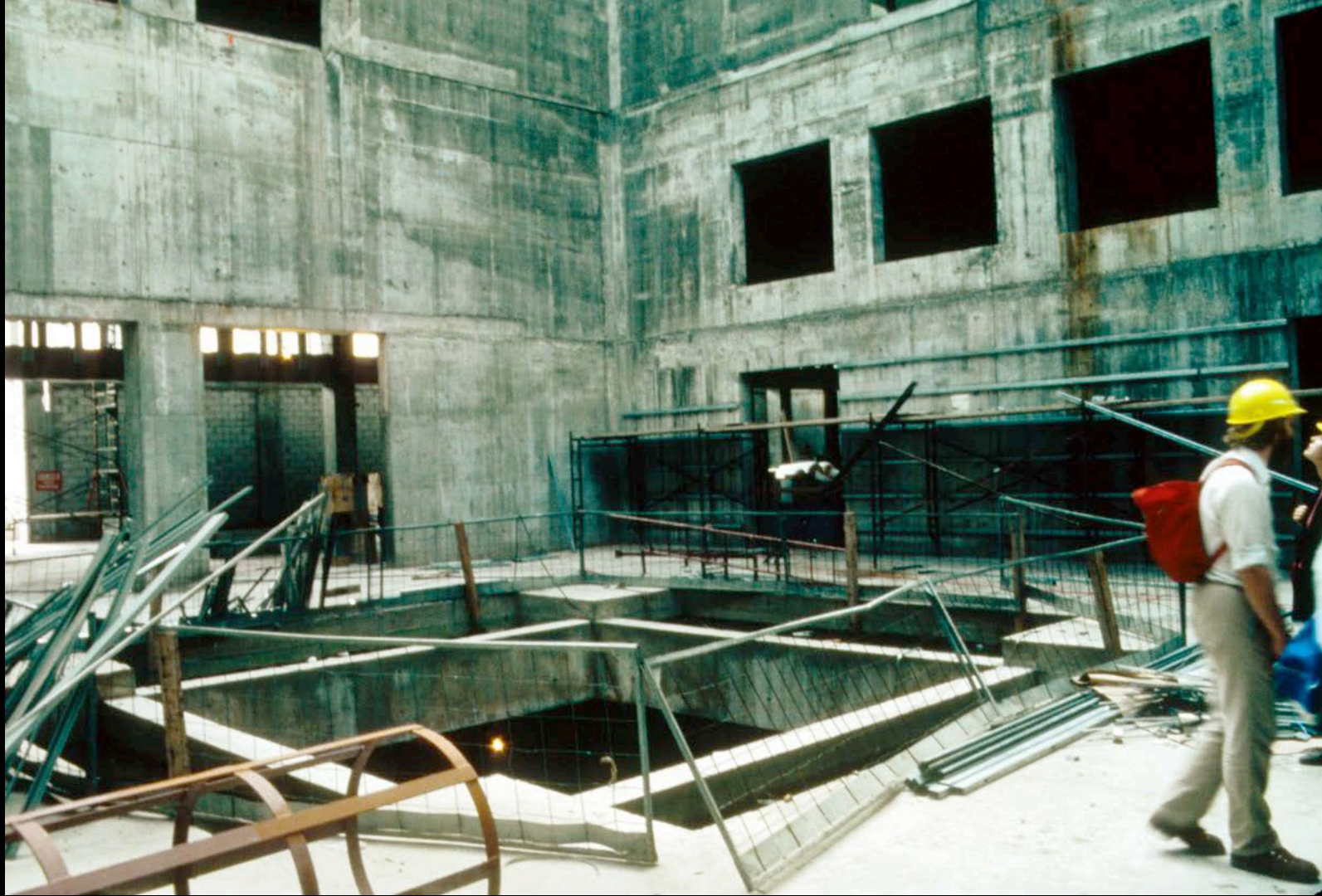











Brunswick Ave. Toronto





























Office Building  
Washington, D.C.

























Miami Aquarium



























Ryerson Student Centre, Toronto  
Snohetta

RYERSON UNIVERSITY STUDENT LEARNING CENTRE









**EllisDon**  
We build on great relationships™

CHRYSLER  
SCHEIDT &  
BONNEMAN  
800-782-1500

Visit the market **AUGUST 21**  
& **SEPTEMBER 18,**  
and join us for a special event on  
**OCTOBER 16.**  
.....  
**11 A.M. - 3 P.M.**  
**RYERSON SQUARE**  
VICTORIA AND GOULD STREETS

STREET CLOSURE  
TEMPORARY

**DANGER**  
DO NOT  
REVERSE  
EQUIPMENT

















**STARBUCKS**























1111 Franklin Road, Miami  
Herzog and deMeuron





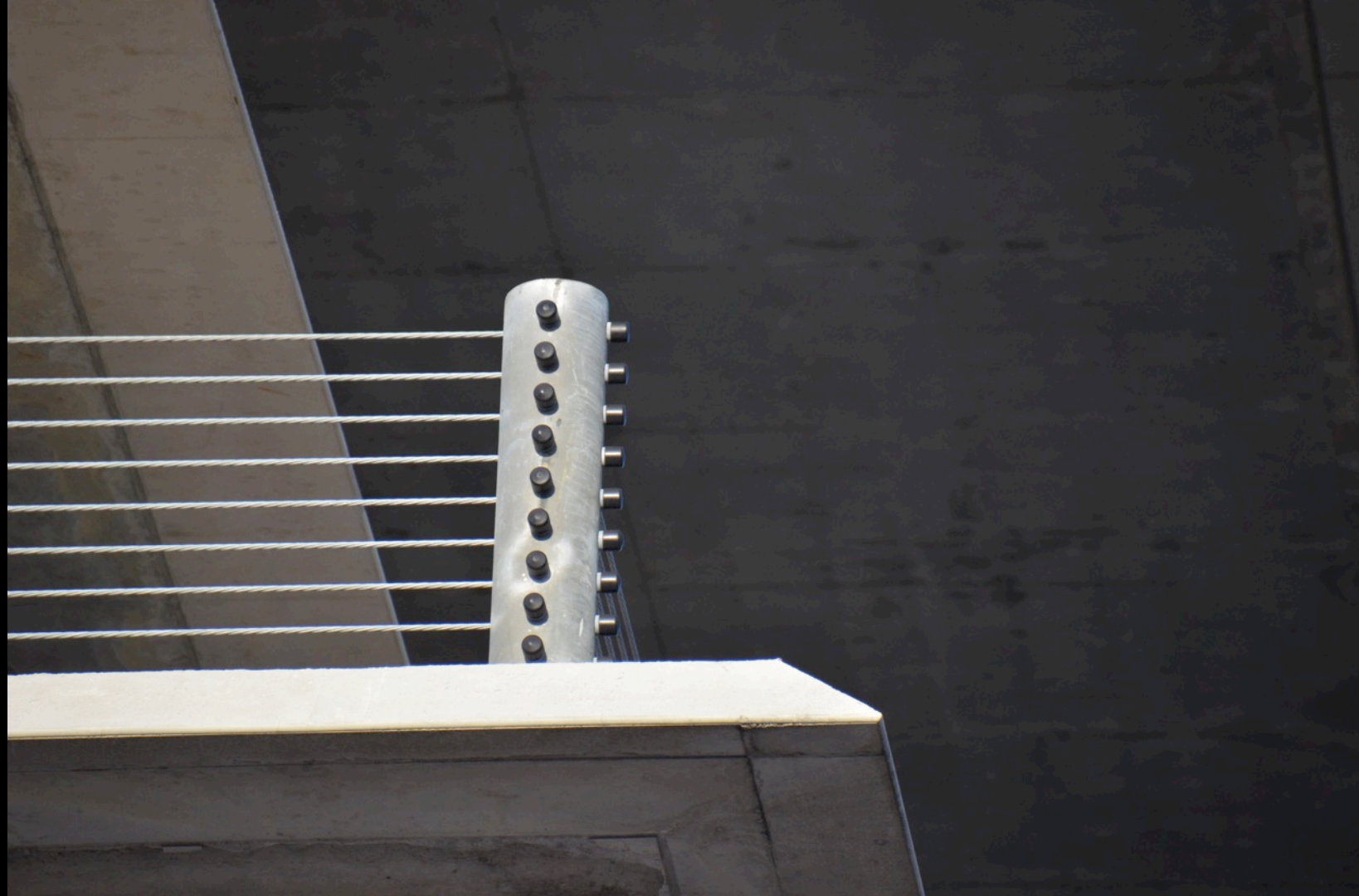











EXIT









Miami Art Gallery  
Herzog and deMeuron









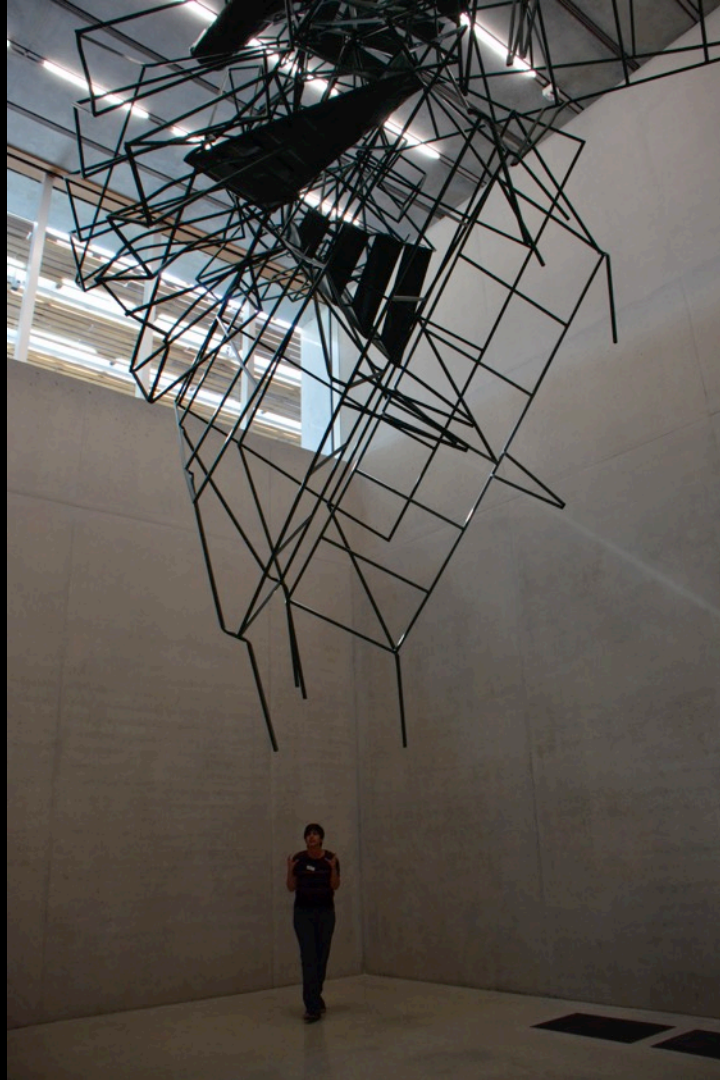





10 Hudson Yards  
New York City, USA  
KPF Architects  
2015  
267.7m









**Self cleaning concrete** is called photocatalytic concrete  
Invented in Italy  
Depends on titanium oxide additive to "eat" pollution

It was touted as a technological miracle to keep concrete from getting stained by pollution, but not working as well as expected.



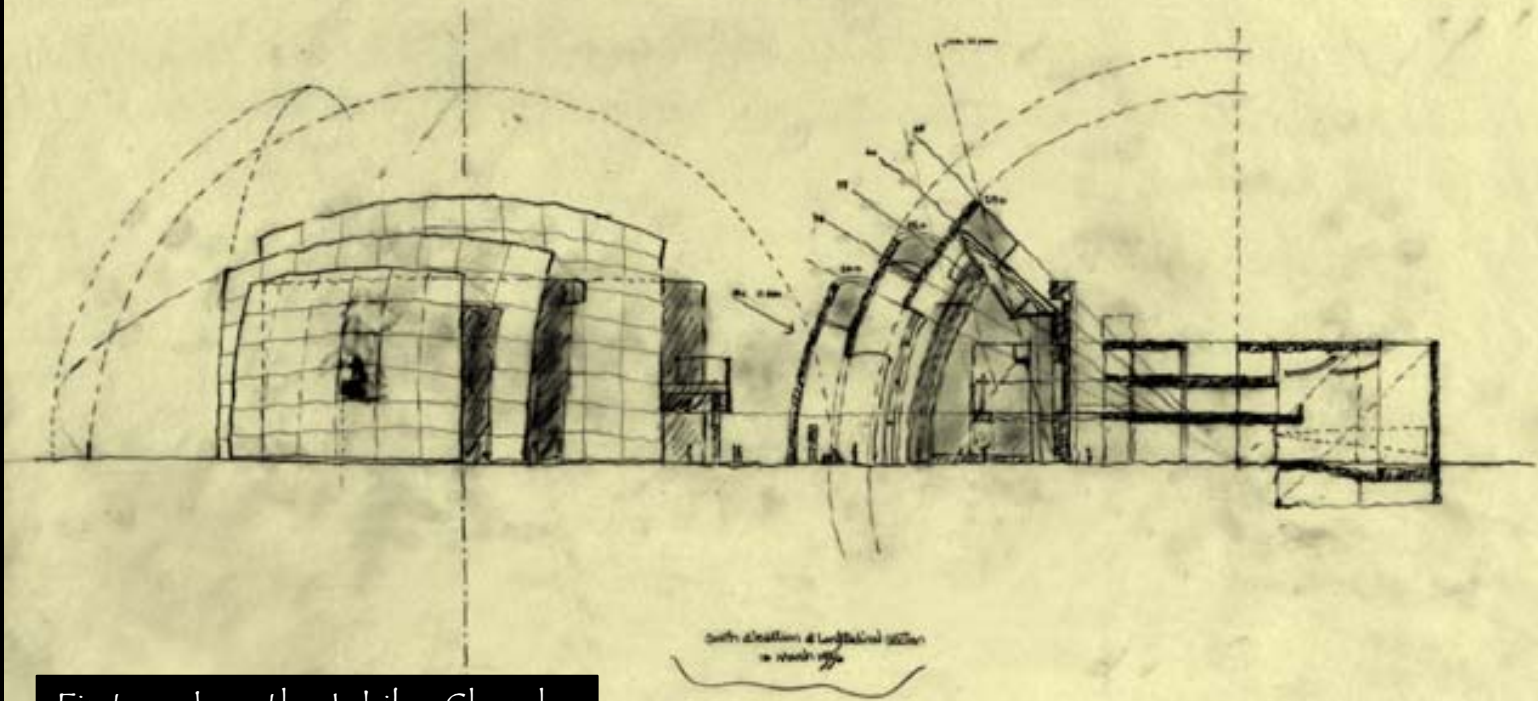

First used on the Jubilee Church  
by Richard Meier in Rome, Italy  
2003

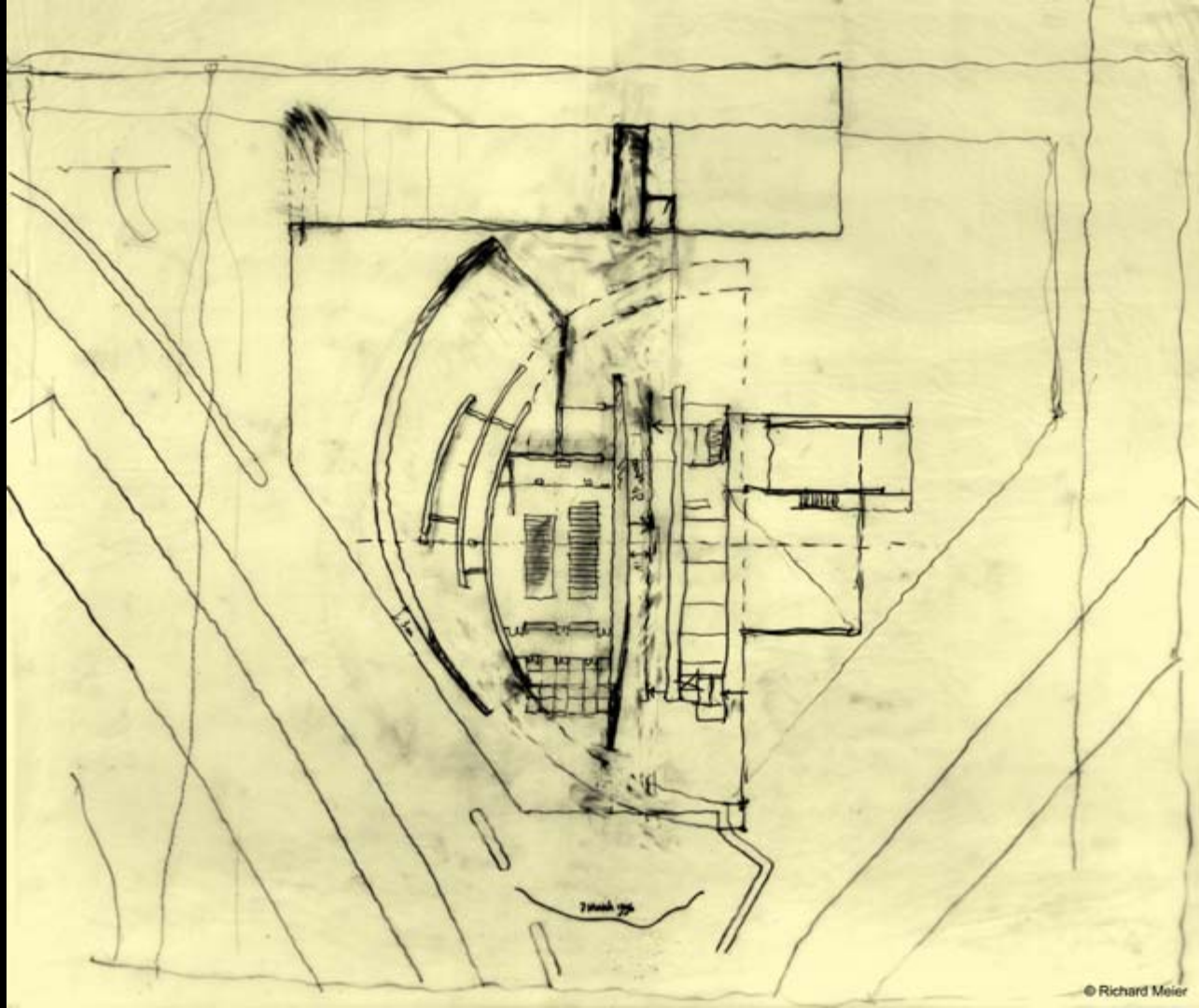



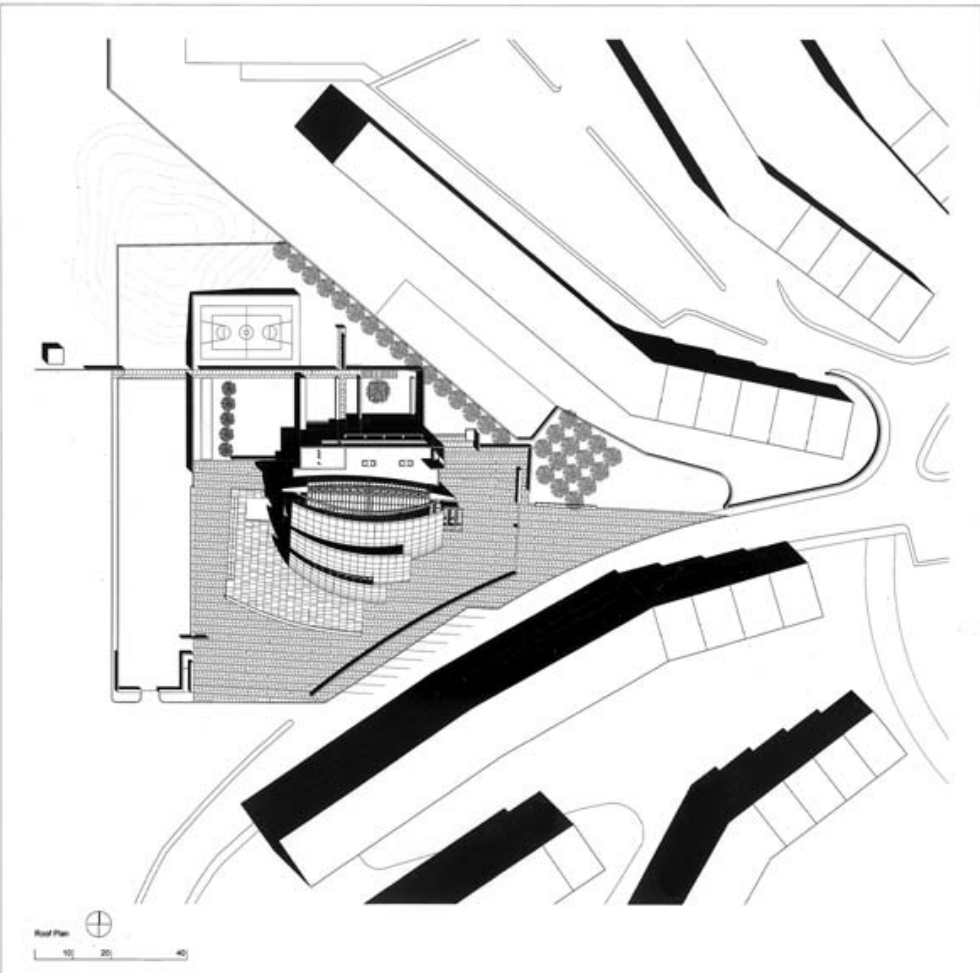

© Richard Meier & Partners, Architects

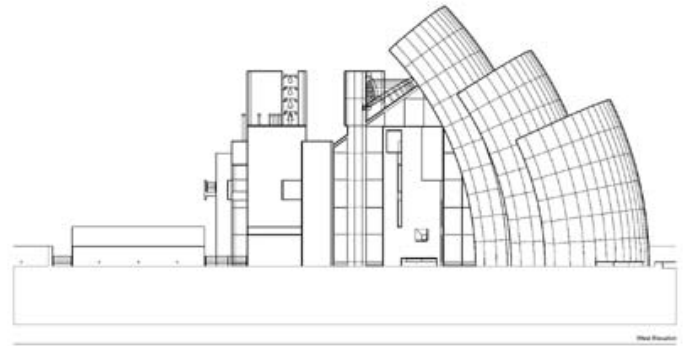
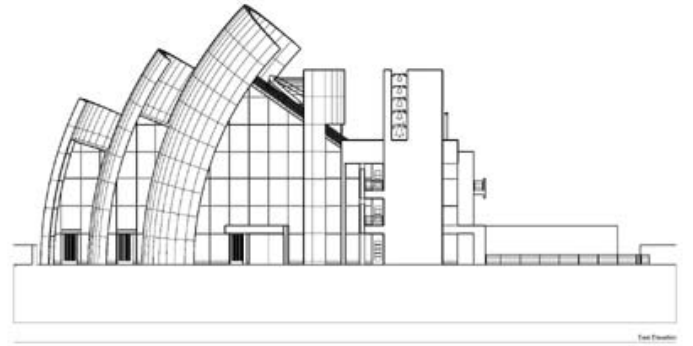

© Richard Meier & Partners, Architects

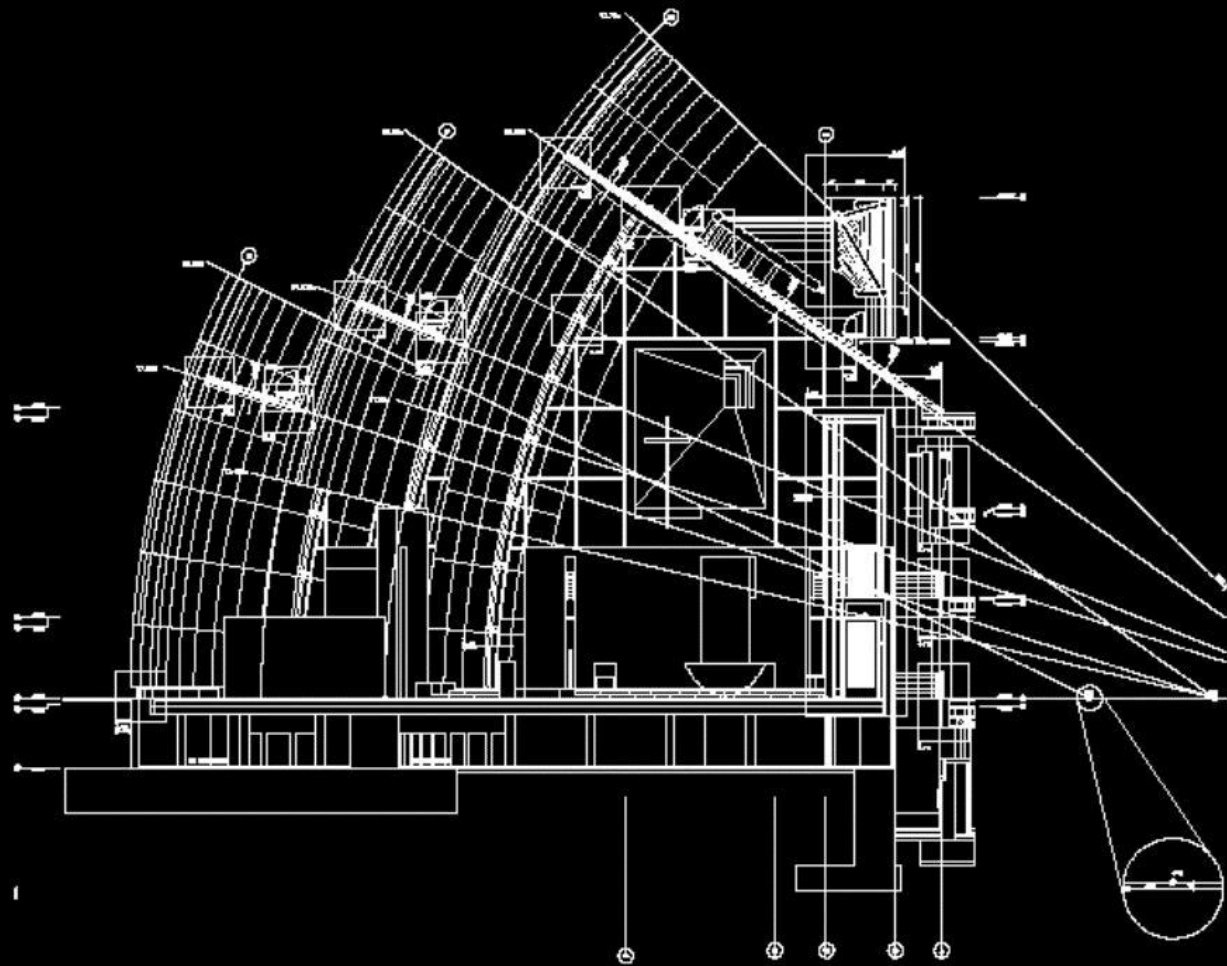























[https://www.researchgate.net/figure/View-of-the-damages-on-the-surface-of-the-self-cleaning-concrete-shells-of-Jubilee-Church\\_fig29\\_337427859](https://www.researchgate.net/figure/View-of-the-damages-on-the-surface-of-the-self-cleaning-concrete-shells-of-Jubilee-Church_fig29_337427859)

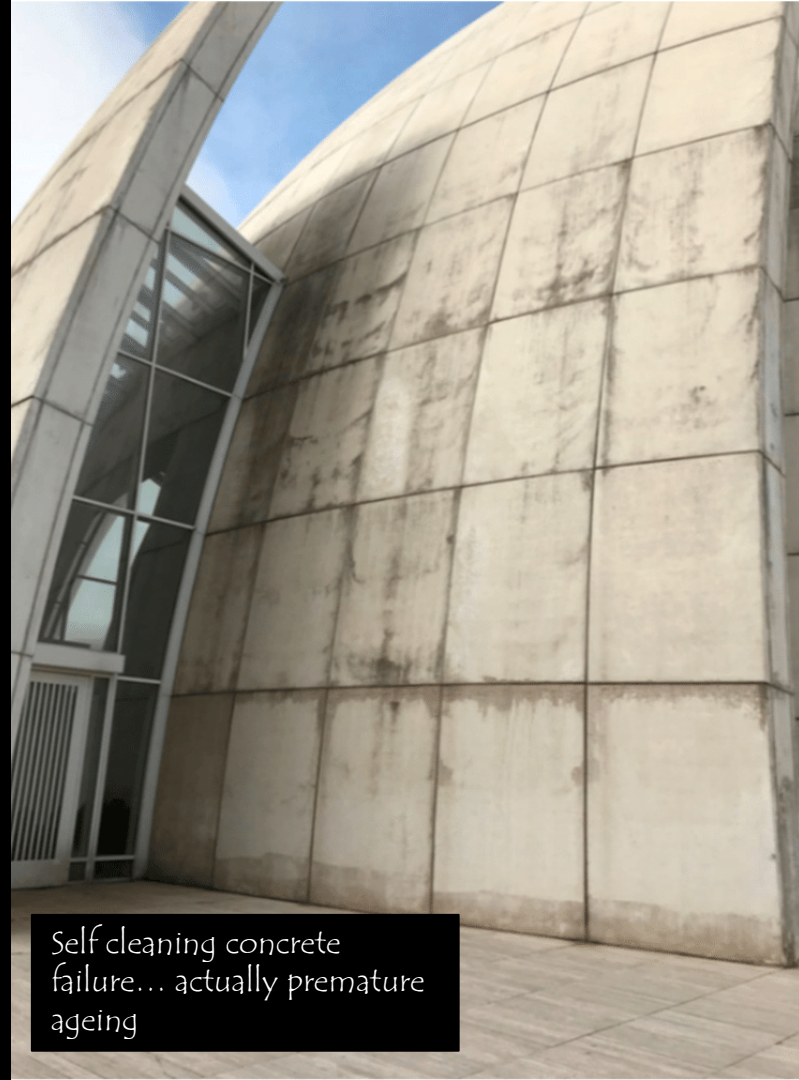

Self cleaning concrete  
failure... actually premature  
ageing