

Arch 173: Building Construction 2

Introduction to Building Science

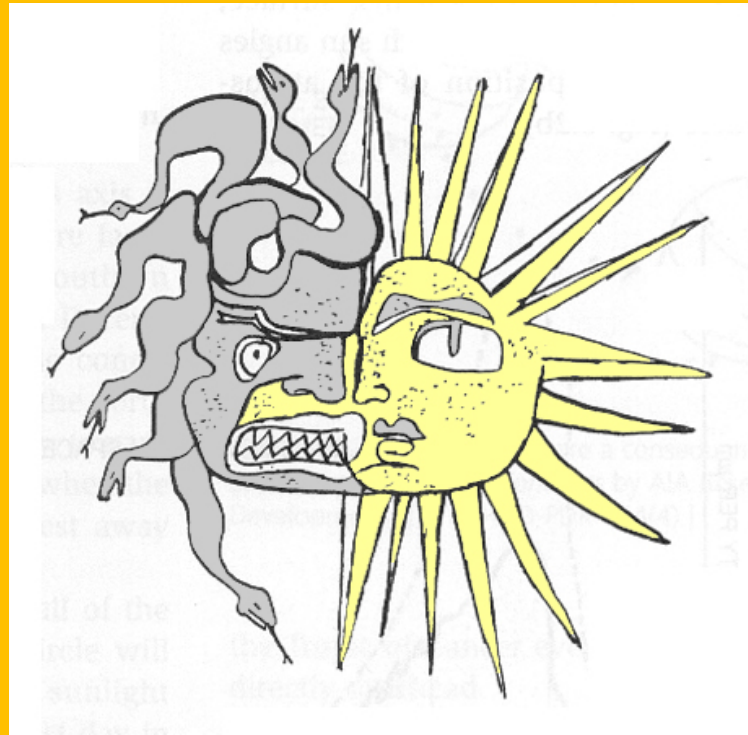

The Building Envelope –
where Building Construction meets
Environmental Design

Welcome to the world of the juggler!!



- Let sun in for free heat
- Keep sun out for free cooling
- Let wind pass through for free ventilation
- Block winter wind to keep the place warm
- Thermal mass vs insulation placement
- Daylight for light when glass also lets heat escape



HOT-HUMID



TEMPERATE



HOT-ARID



COLD

ENVELOPES FOR DIFFERENT CLIMATES ARE DIFFERENT!

Understanding Your Climate

What is Climate?

- Temperature
- Solar radiation
- Humidity
- Pressure
- Rain, snow, fog
- Visibility
- Wind speed and direction

Weather vs. Climate

Climate is a Historical Record:

- 30+ years of data
- 24+ records/day

Weather and Climate:

The weather of the world varies by location as relates to the distance from the equator and as influenced by aspects of geography such as the trade winds, adjacency to bodies of water, elevation, etc.

The earth's atmosphere helps to moderate the climate to prevent radical shifts in temperature from season to season and day to night.

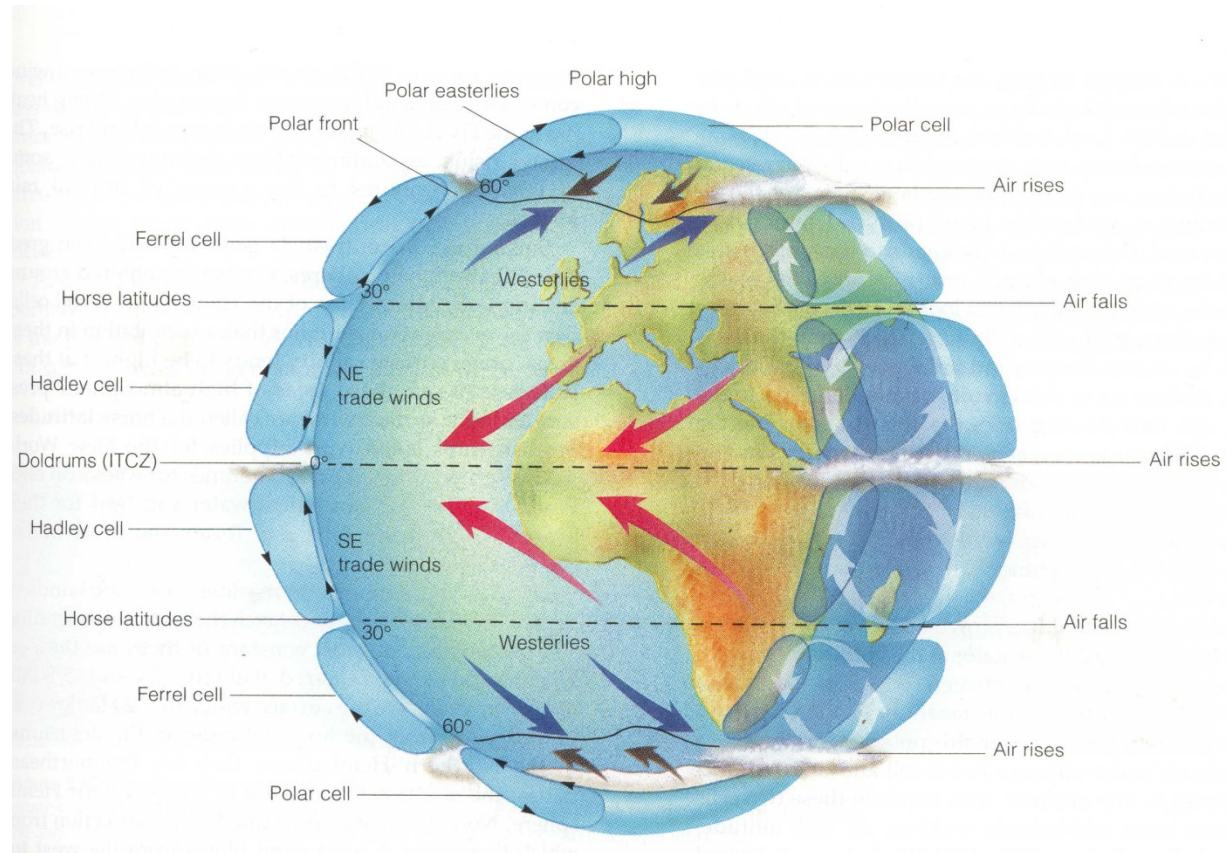

The four seasons...

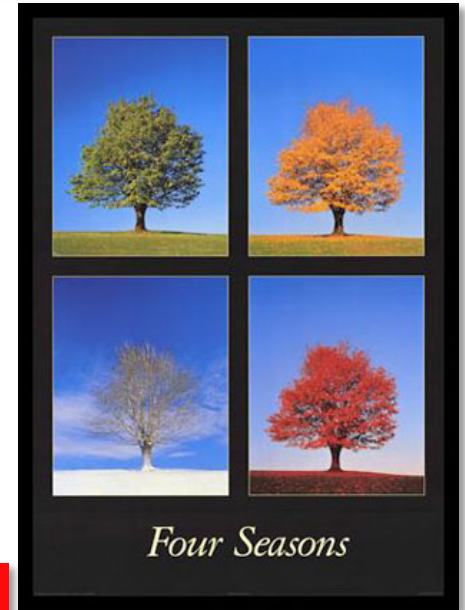

...ask for variance in the performance of our buildings – either in keeping the cold OUT or letting the cool IN.



Degree Days

- These are a measure of the severity of a climate
- Termed as “heating” or “cooling” degree days to reflect requirements in the winter versus summer
- Measure of the deviation from 18°C for the summation for 365 days of the year based on climate data for a typical year
- So for a cold climate like Cambridge the heating degree days will be higher than the cooling degree days

Low technology shelters



Simply put. In Western “civilized” culture, providing *shelter* is no longer enough. Modern buildings must endure the contemporary person’s needs for comfort, separation from outside elements, and accommodation of more demanding daily activities.

High Performance Buildings



Greater London Authority, Norman Foster

These buildings also have “thin skins”. But nowadays, people expect an awful lot **MORE PERFORMANCE** from their buildings – as technological symbols and cultural icons. *Shelter is just not enough.*



Channel 4 News, London, Richard Rogers

Technique vs. Technology



Old stone buildings relied on their **massive** nature to withstand the weather. New buildings are comprised of **thinner** layers, that are individually less able to withstand the elements.



Additional pressures on modern buildings



The “*clean*” lifestyle puts high amounts of moisture into our interior environments that are pressure fed through the walls by high temperatures and deteriorate the envelope on their way through.



From Vitruvius to the present:

A building must satisfy several general requirements. It must be:

- **safe** in respect of structure, fire and health
- **economical** in initial cost and operating cost
- **aesthetically** pleasing,
- **inoffensive** to the senses and an aid in sensory tasks.

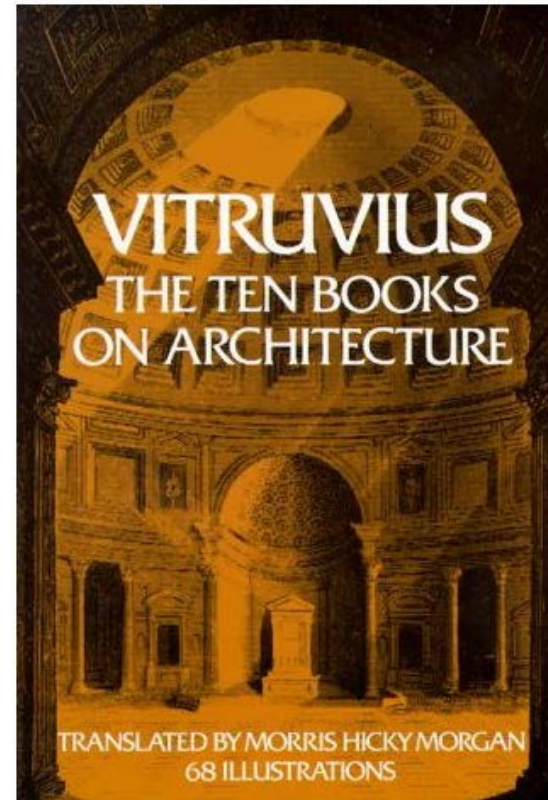

Vitruvius' version was
“strength, utility and aesthetic effect”

Safety:

To achieve **safety** it must provide:

1. structural strength and rigidity
2. resistance to initiation and spread of fire
3. control of air and water quality and means for waste disposal

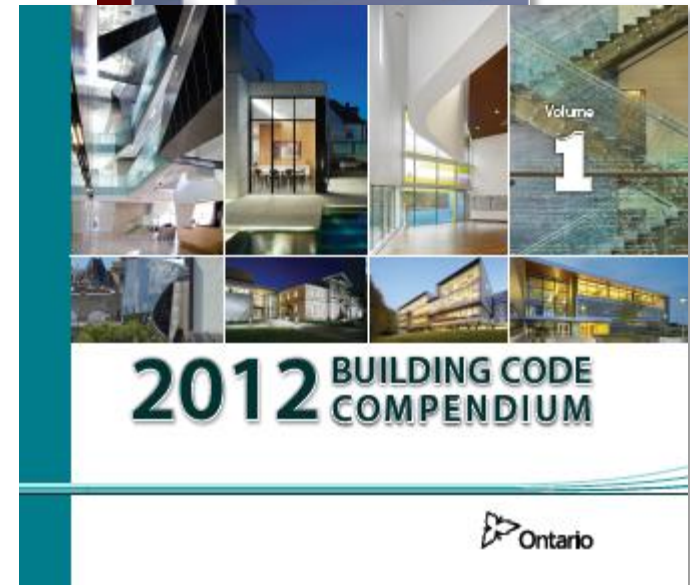

Economy:

To achieve **economy** it must:

1. be well matched to its purpose
2. have durable materials and components
3. have reasonable maintenance and operating costs



Inoffensive:





To be inoffensive and an aid in sensory tasks it must provide control of:

1. odors
2. light
3. sound vibrations



Environmental Moderator:

To function as a moderator of the environment and to satisfy all other requirements, it must provide control of:

1. heat flow 
2. air flow 
3. movement of water as vapour and as liquid 
4. solar and other radiation 

Building envelopes are like balloons...



Building envelopes are like balloons... very thin but their performance is critical!



Performance failure...

Just like the balloon, if the envelope is compromised or punctured, it does not work very well.

Balloons and (cold climate pressurized) buildings both have high pressure on the inside that **DRIVES** the air inside the building to **ESCAPE** to the outside.



Bio-climatic Design: COLD

Where **winter** is the dominant season and concerns for conserving heat predominate all other concerns. **Heating degree days** greatly exceed cooling degree days.

RULES:

- First **INSULATE**
- *exceed* CODE requirements (DOUBLE??)
- minimize infiltration (build tight to reduce air changes)
- Then **INSULATE**
- **ORIENT AND SITE THE BUILDING PROPERLY FOR THE SUN**
- maximize south facing windows for easier control
- fenestrate for **DIRECT GAIN**
- apply **THERMAL MASS** inside the building envelope to store the FREE SOLAR HEAT
- create a sheltered MICROCLIMATE to make it LESS cold



YMCA Environmental Learning Centre,
Paradise Lake, Ontario

...designing for a cold climate...



Designing for a cold climate requires a completely different approach to and respect for the weather. Buildings must be designed with an environmental barrier.



Traditional cold climate design:



At this time heating costs were low, nobody was concerned about CO₂ emissions and global warming, so fossil fuels were burned.

Traditional cold climate design in Canada took to task the shedding of snow from roofs and used minimal windows in the walls to try to keep heat inside the building.



Cold climate cathedrals:



Buttressing systems in stone allowed for the enlargement of glazing systems that were once hindered by the limitations of the wall – giving more light and heat to the interior of cold, draughty cathedrals.

The building envelope is like a fur coat...



Fur was one of the first materials used to provide protection from extreme cold.

It works because it **traps air** between the hair, providing “insulation” from heat loss to the cold outside.



Insulation is the “fur coat” for buildings...



Different types perform different ways, as a function of their materiality and thickness. *More is more...*

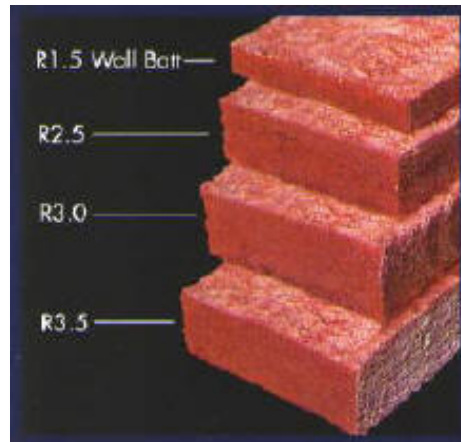



cellulose

fiberglass



Sheep's wool

Insulation is the only real way to keep the heat in. Some types are more environmentally friendly than others.

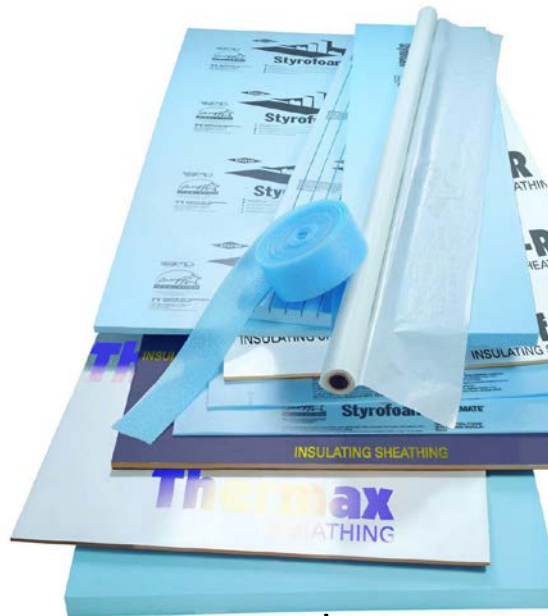

polystyrene

Sustainable Insulation

Alternates are in... – including, recycled paper, recycled denim, soya based, hemp, icynene...

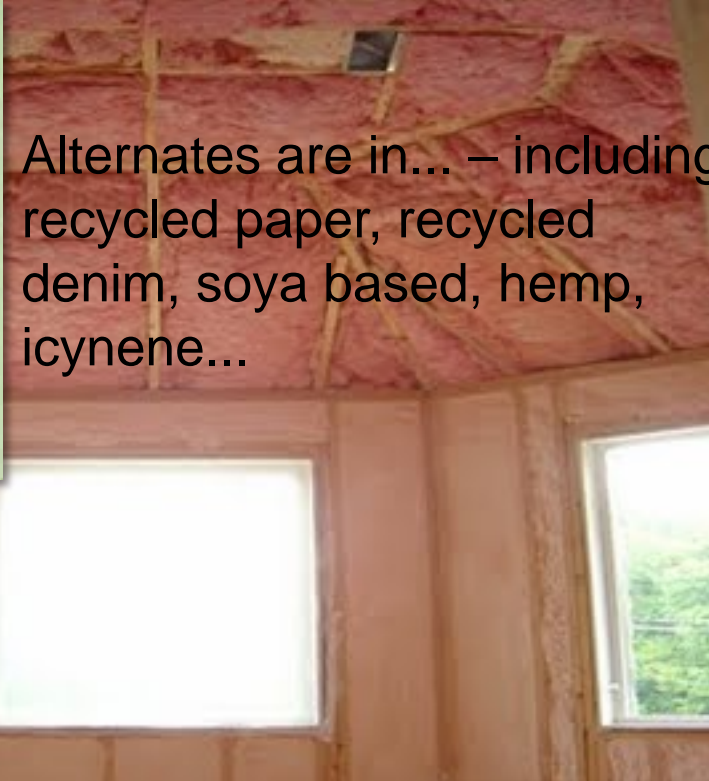

Fibreglass is out!



Buildings must provide shelter from rain



Identifying “the enemy”

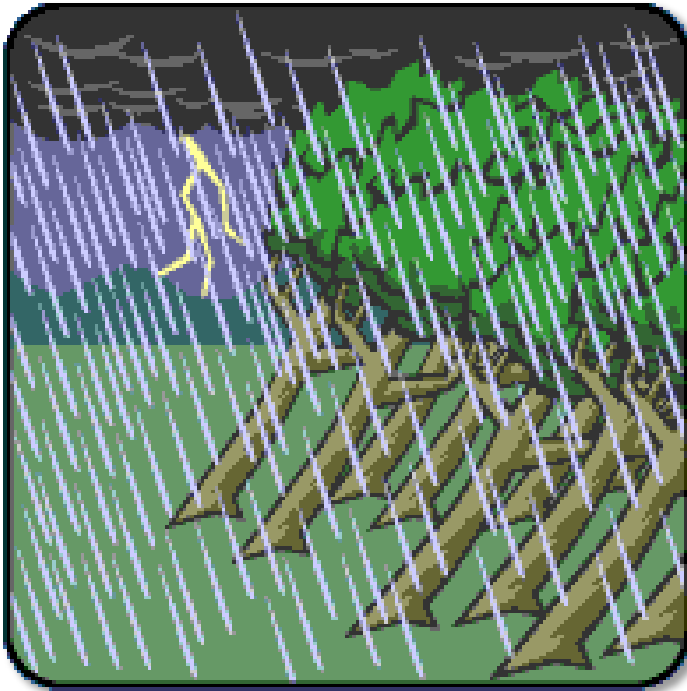

Rain is likely the largest enemy of both the Architect and the Building Envelope. Moisture damage to the building envelope is one of our key concerns when looking at GOOD building envelope design.

A roof is like an umbrella...



And we like BIG umbrellas as they provide better protection against rain because they overhang our body more.

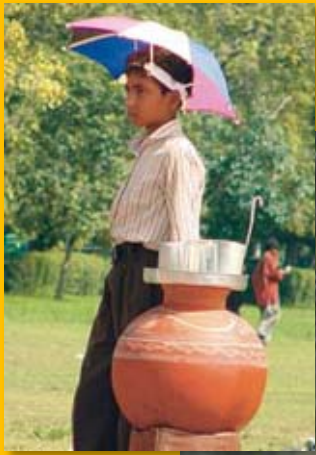

Why does this man look happy? Because he has a BIG umbrella!

The size of a roof overhang...



The purpose of the roof overhang is to shed rain / snow from the roof. If it does not project adequately beyond the face of the building, water will drain down the face of the building, bounce in the dirt around the foundation, and cause wetting issues. *Flat roofs normally provide NO overhang so offer NO protection for the walls of a building.*

Heat flow

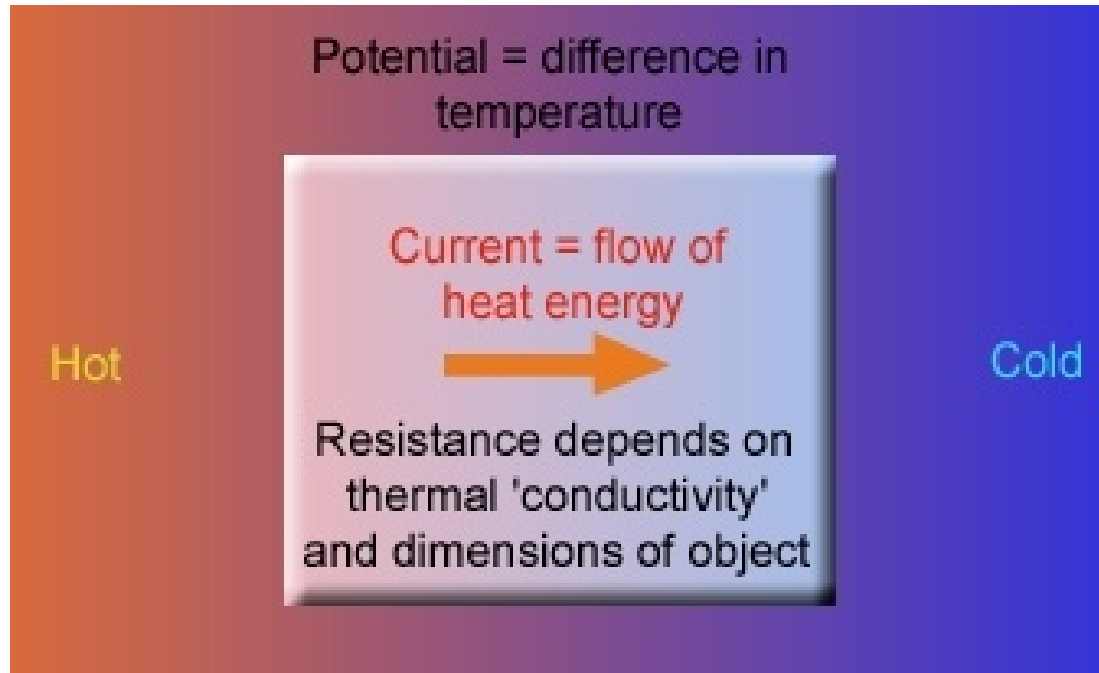

The heat that flows through the building envelope follows the “rules of science” – migrating from **HOT to COLD**. This is true in winter and summer – meaning the flow reverses as a function of the season and temperature.

The R-Value and U-Value

The **R-VALUE** is the measure of the ability of a material to **RESIST** HEAT FLOW. The bigger the number, the better the material.

In buildings we want these numbers to be **BIG**.

The **U-VALUE** is the measure of the ability of a material to **CONDUCT** HEAT FLOW. In buildings we want these numbers to be **SMALL**.

The U-Value is the **INVERSE** of the R-Value...

$R = 1/U$ and conversely, $U = 1/R$

Units of $R = \text{m}^2 \cdot \text{°C} / \text{Watts}$

Units of $U = \text{Watts} / (\text{m}^2 \times \text{°C})$

Buildings are like radiators



The more surface area a building has, the more envelope to build and the more heat can escape through the walls. Not that we should only design “efficient boxes”, but something to be kept in mind...

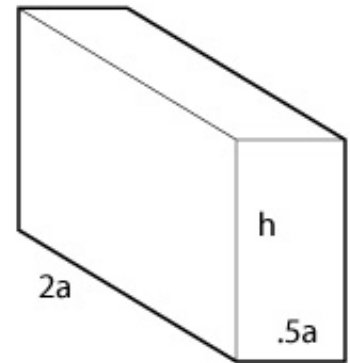
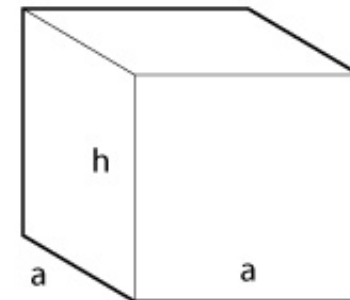

	square bldg	rectangular bldg
floor area	a^2	a^2
surface area	$4*ah + a^2$	$5*ah + a^2$

Square Plan vs. Rectangular Plan Buildings,
with same floor areas and height.

Surface Area of the Envelope



The sawtooth surface of the Royal Bank Building in Toronto greatly increases its area for heat loss.

Temperature

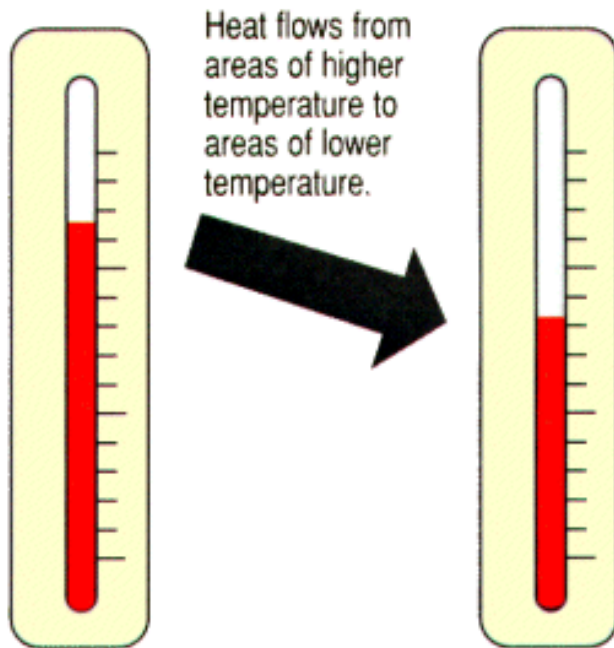

The **BIGGER** the temperature difference from Inside to Outside (or vice versa) the greater the **PUSH** for heat flow.

If it is -23°C outside and $+23^{\circ}\text{C}$ inside, the temperature difference is 46°C ! *Big PUSH.*

If it is 18°C outside and 23°C inside, the temperature difference is only 5°C .
Not much push.

Hence MORE important to have a fantastic building envelope in a harsh climate.

Temperature differential

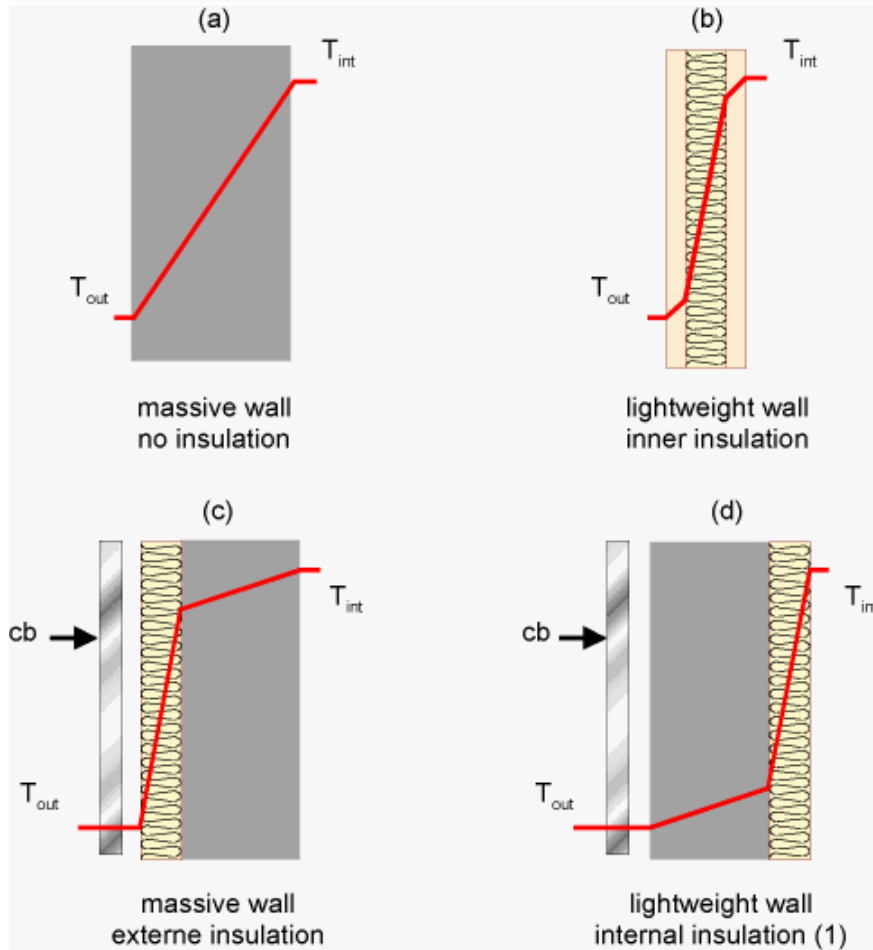

We use insulation to **slow the transfer of heat** across the building envelope.

The placement of the insulation is important as we want to **keep the structure (support system) WARM** so that it does not expand and contract too much.

We also want our inside surfaces **WARM** so that we don't have condensation occurring on the inside surfaces which will cause mold...

Dew point

The DEW POINT is the temperature at which air of a certain level of Relative Humidity will cool and the water vapour will condense into a liquid form (100% RH).

Condensation can lead to **mold**.

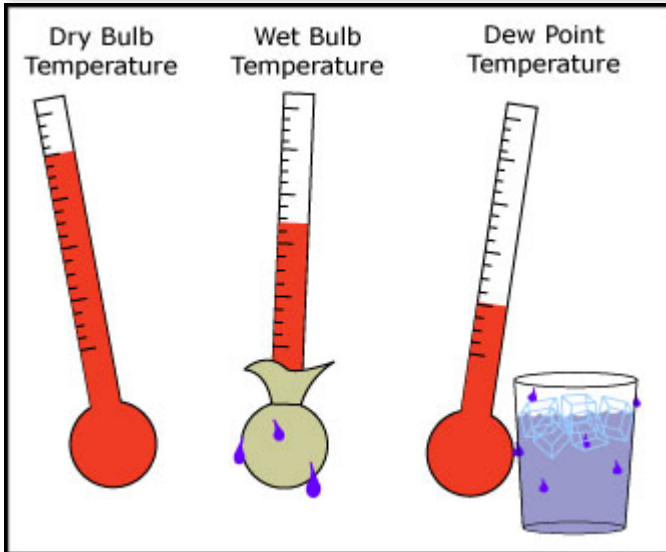

Thermal Bridges!!! - BAD

THERMAL BRIDGES are places in the building envelope where there is no insulation.

This allows the heat from inside to flow to the exterior without any “delay”.

This means that someone is paying for heat that is being wasted.

Such points in the envelope also “feel cold” on the inside, so can cause condensation, mold and mildew problems.

With few exceptions, **THERMAL BRIDGES SHOULD BE AVOIDED AT ALL COSTS!**

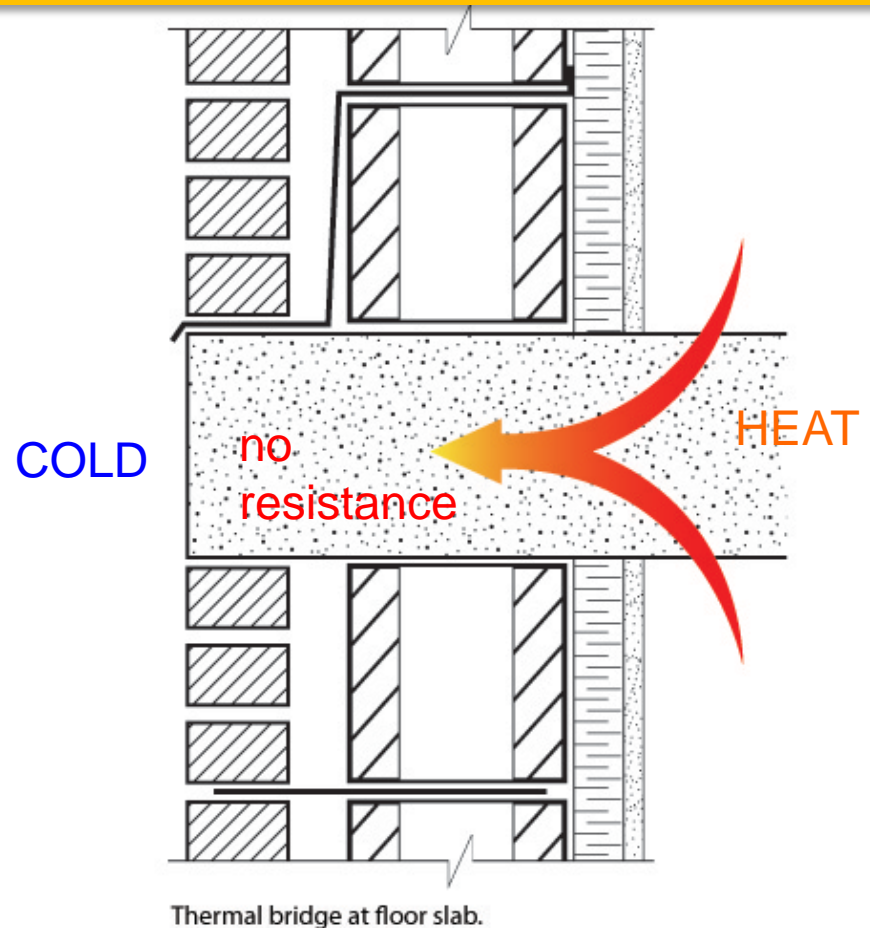

The Controversial “Cover” of GreenSource Magazine

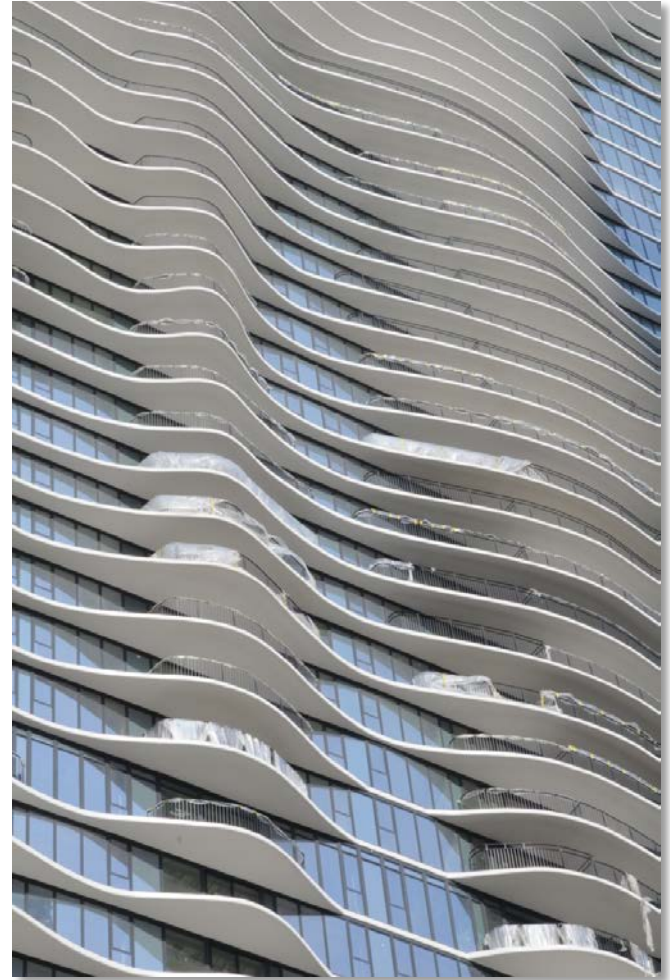

A “sustainable” Chicago residential skyscraper – going for LEED

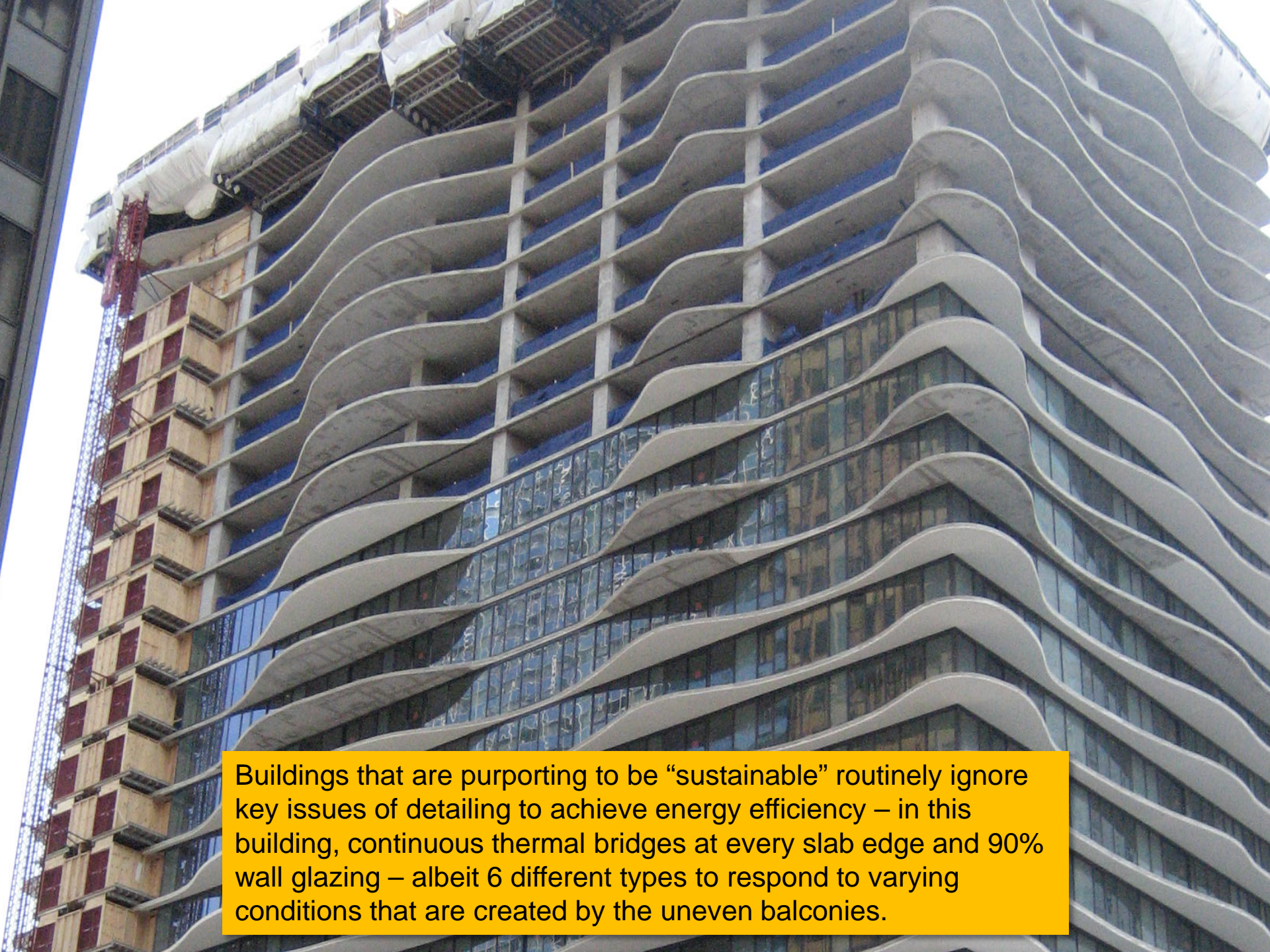

Buildings that are purporting to be “sustainable” routinely ignore key issues of detailing to achieve energy efficiency – in this building, continuous thermal bridges at every slab edge and 90% wall glazing – albeit 6 different types to respond to varying conditions that are created by the uneven balconies.

The “classic” bad balcony detail

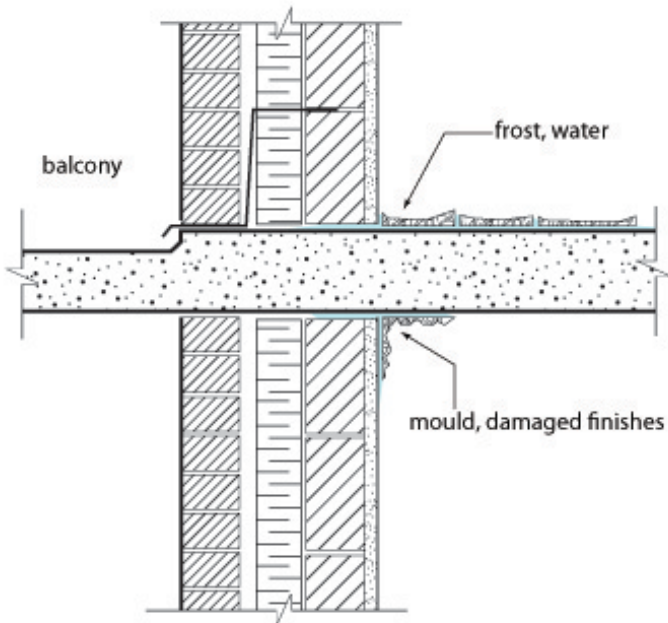

Effect of thermal bridge when indoor relative humidity is appreciable (above 20% RH in midwinter)

Design Example (a)

The three storey apartment building shown is to be located in Toronto, Ontario (north latitude 43.7° from Table C.1 of this Appendix, 4082 heating degree days from Table A.1 of Appendix A). Overall building dimensions are 16×40 m. The long wall shown faces due south. Sliding glass doors are partially shaded by overhanging balconies as shown. Calculate the effective area of glazing of each sliding glass door assuming the following:

Dimensions of glazed area —

$$1.98 \times 2.03 \text{ m} = 4.02 \text{ m}^2$$

Thermal resistance (R value) —

$$0.30 \text{ m}^2 \cdot ^\circ\text{C}/\text{W}$$

Shading coefficient — 0.80

Building heated in winter with forced air system.

No air conditioning in summer.

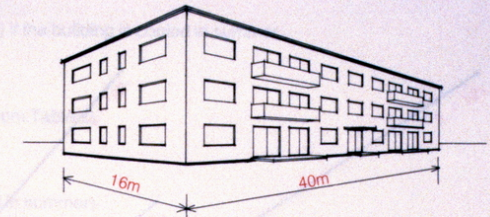

Design Example — Perspective

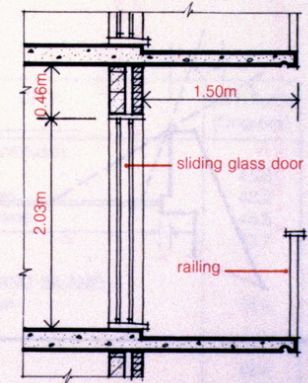

Structurally this has been the *easiest* way to make balconies on apartment buildings – just cantilever the slab out over the walls. But it is also one of the **WORST** building envelope failure conditions.

Fixing the thermal bridge

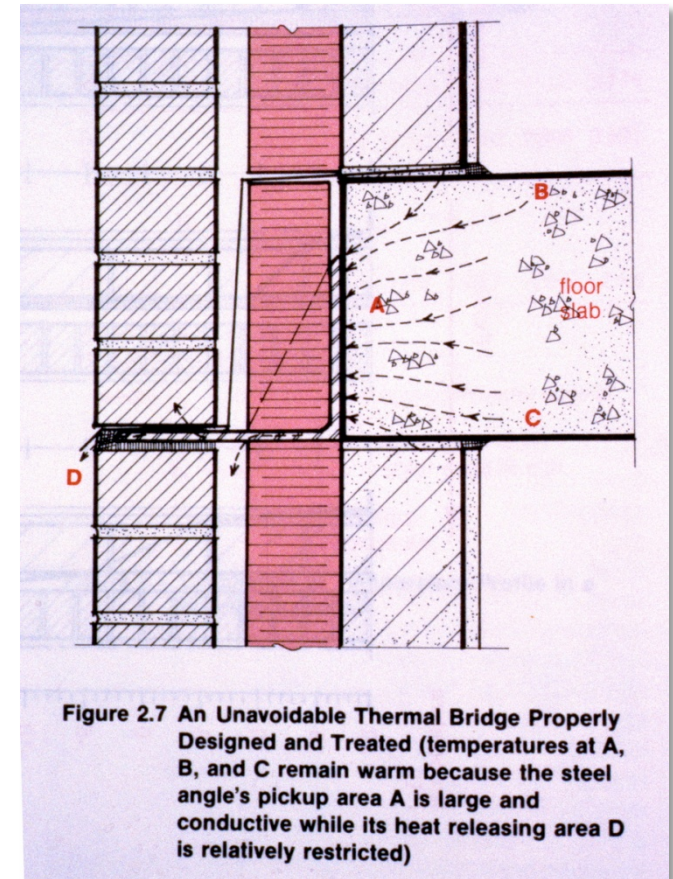
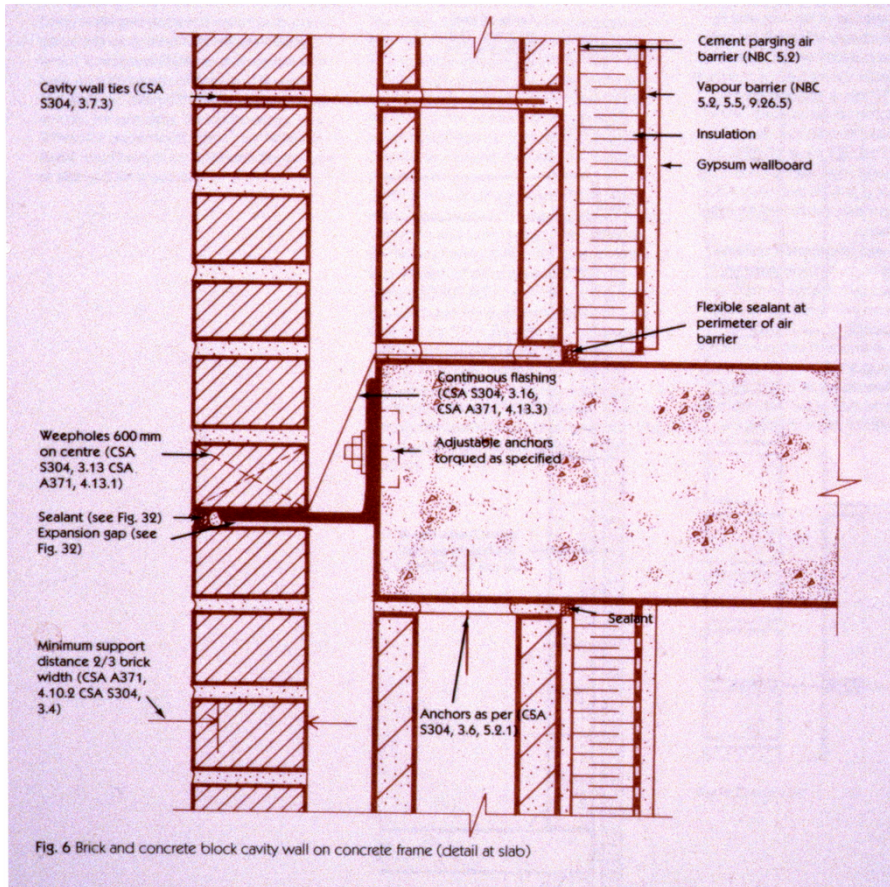

With some intelligent detailing, pretty well all thermal bridges can be avoided.

Watch out for Thermal Bridges

- Thermal bridges can “short circuit” our insulation work
- Places to watch out for:
 - Canopies, Balconies, Soffits, Overhangs, Parapets, Cladding clips



<https://www.architecture.org/learn/resources/buildings-of-chicago/building/aqua/>

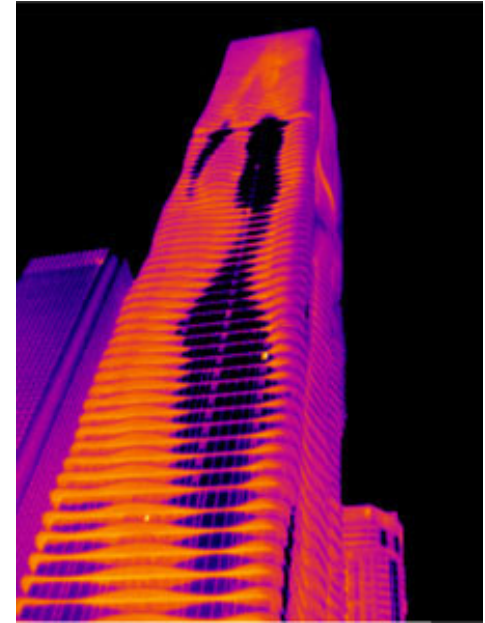

<https://architecturefarm.wordpress.com/2015/07/16/thermal-aqua/>



<https://bellwetherdesigntech.com/>



<https://specificationproductupdate.com/>

Two glass canopies trying to look the same:

One has fins that penetrate at every panel, bringing heat out of the enclosure all winter long. The other has an independent exterior structural system so that there are no penetrations through the enclosure. Neither uses a thermal break, but they could have been employed to save the first from poor performance, and save the second from a clunky exterior support system

Thermal Break for Canopies



<https://www.schoeck.com/en-us/canopy-beam>

Thermal Breaks for Balconies

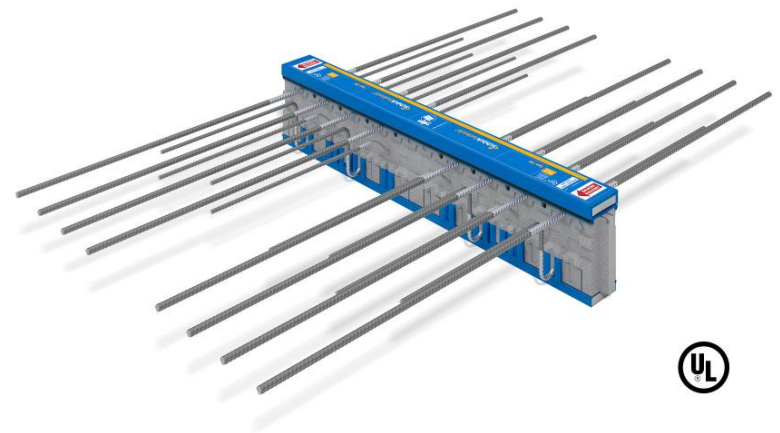

<https://www.schoeck.com/en/isokorb-t-type-k>

Continuity of Insulation in Details

Insulation wraps around the parapet to prevent heat loss in this vulnerable position (because hot air rises)

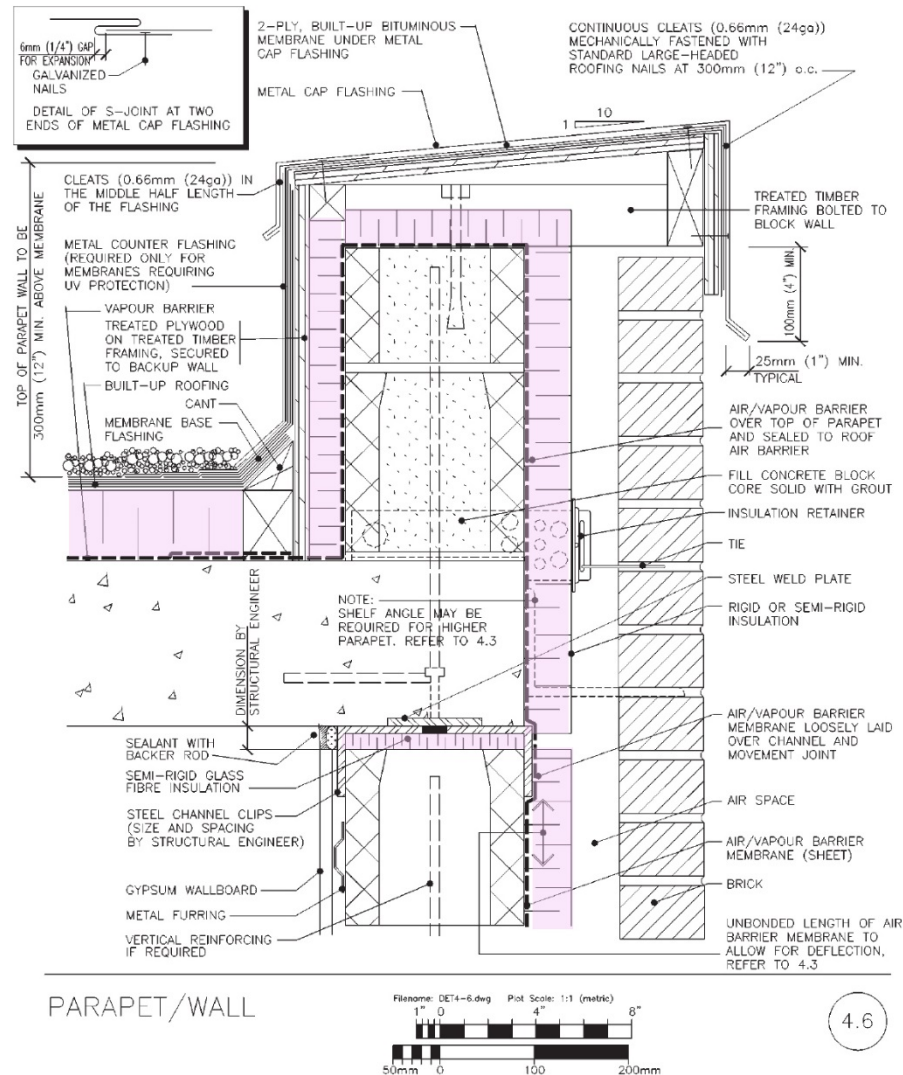

The Tools:

1. Continuous Insulation
 - several materials can do this job, with varying degrees of success: see “**Building Enclosure Fundamentals**” in Reference on LEARN
2. Thermal Breaks
 - design to avoid needing them, minimize the need for them, or flaunt them, but **don’t ever forget about them.**
3. Centuries of Built Work
 - Review precedent, both good and bad, to gain an understanding of what works and what doesn’t.

Instinct Check

- You are building a new project in Ontario: which of these two wall sections will keep your clients warmer in February?

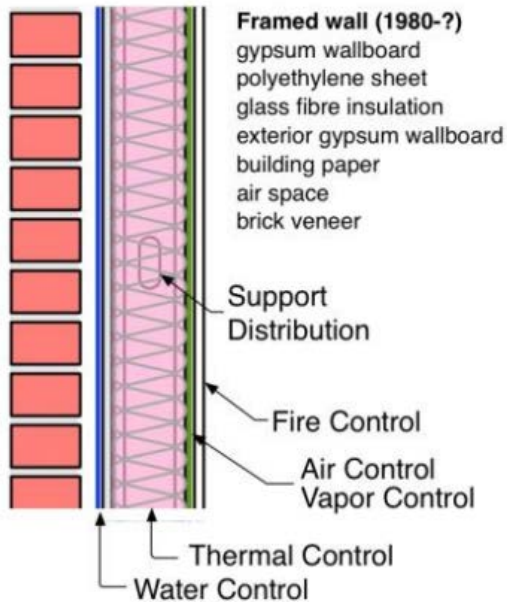

The one with
discontinuous
insulation,
or one with both
discontinuous AND
continuous insulation?

Which one is which?

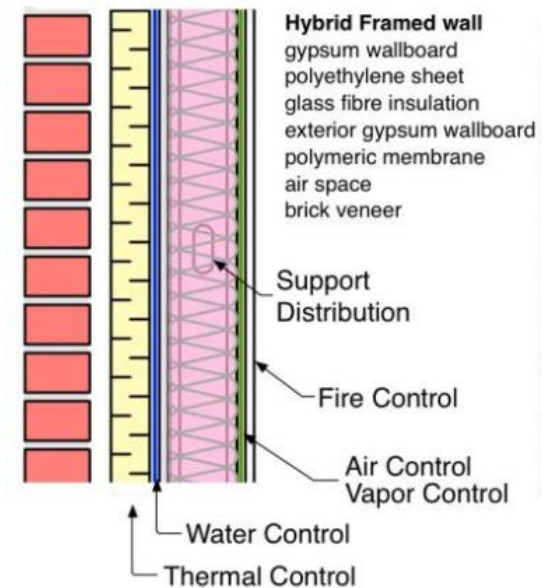

Images: compliments of John Straube

Discontinuous Insulation

- Stud walls are very common in Canadian construction, and can be seen in use at both residential and institutional scales.
- Typically, residential projects use wood studs while institutional, or multi-unit residential projects use steel studs.
- Insulation between studs is great for those spaces, but at the locations of the studs, there is **thermal bridging**.

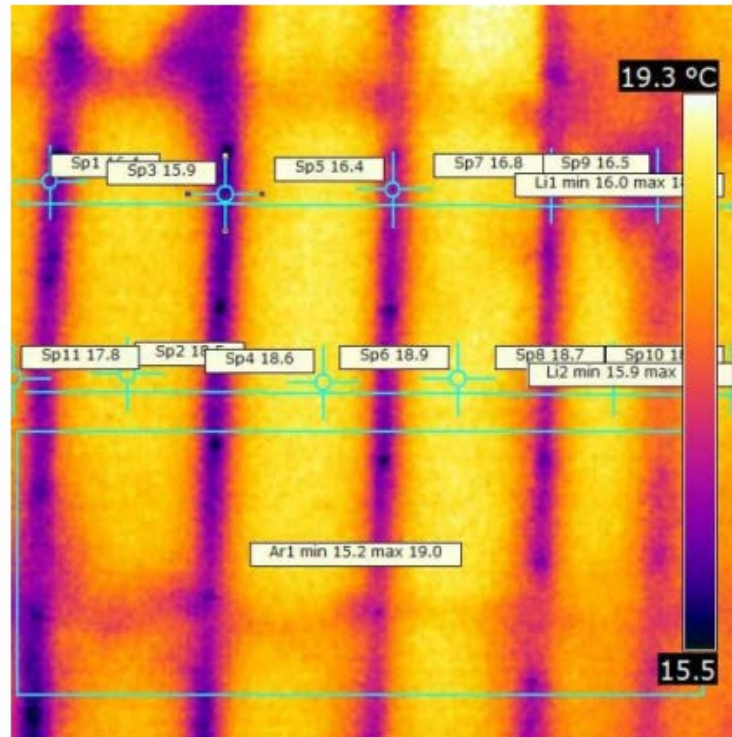

Images by Ali Taileb and Hamoud Dekkiche



Image by Marianne Touchie





<https://www.vironix.com/mold/learning/interior-mold/ghosting-or-mold/>



<https://www.howtolookatahouse.com/Blog/Entries/2018/6/what-causes-dark-or-light-ghost-lines-on-ceilings-and-walls-1.html>

Nominal (rated)



Effective (clear wall)

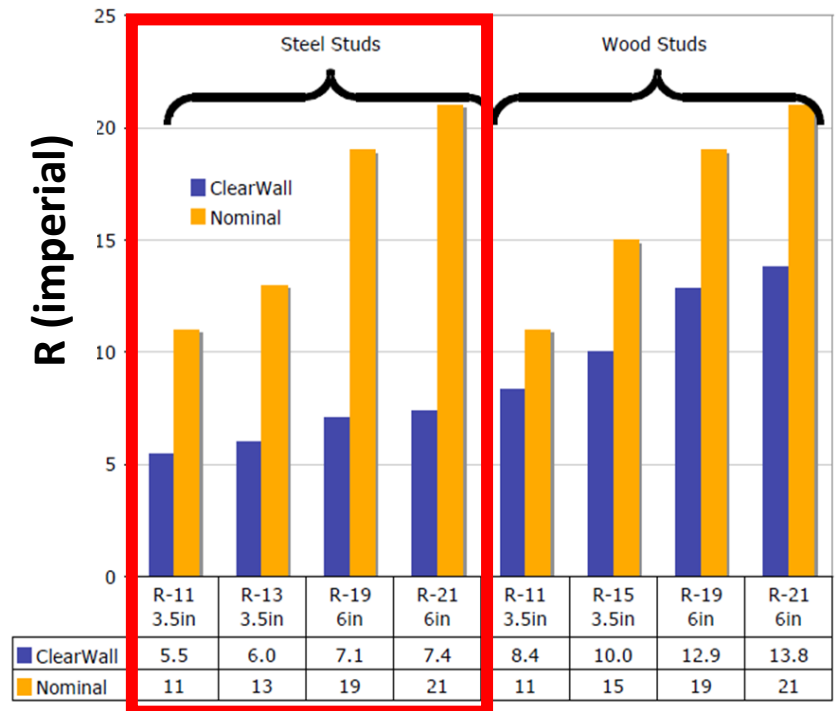
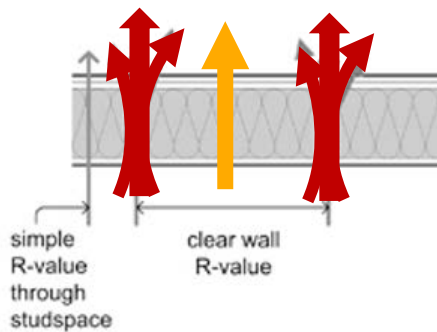

Figure 3: Nominal and Clear Wall Insulation R-values (after ASHRAE 90.1-1999) for Several Different Stud Materials and Insulation

Image John Straube. Thermal Metrics for High Performance Wall Enclosures: The Limitations of R-Value

It is Best to Wear Your Coat, not EAT Your Coat!

- One of the many favourite one-liners of John Straube.
- **Continuous exterior insulation is by far a better solution** than only interior stud insulation. Some systems even use both.
- Insulating between steel studs without any exterior insulation is a waste of time because steel studs are very efficient to conduct heat.

It is Best to Wear Your Coat, not EAT Your Coat!

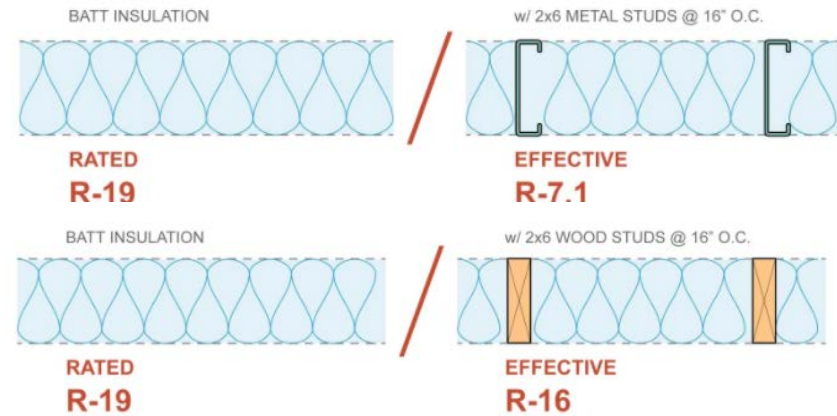

Image by Energy Vanguard, diagrams by Daniel Overbey

The Impact of Windows

- Window-to-wall ratio (WWR): the fraction of the above-grade wall area covered by fenestration

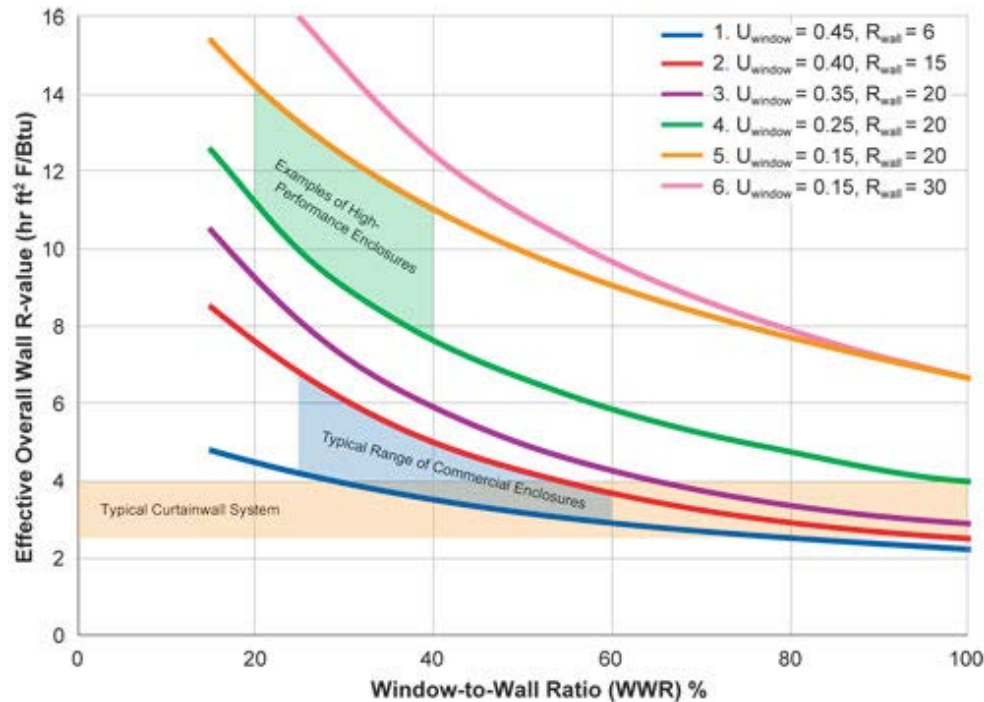
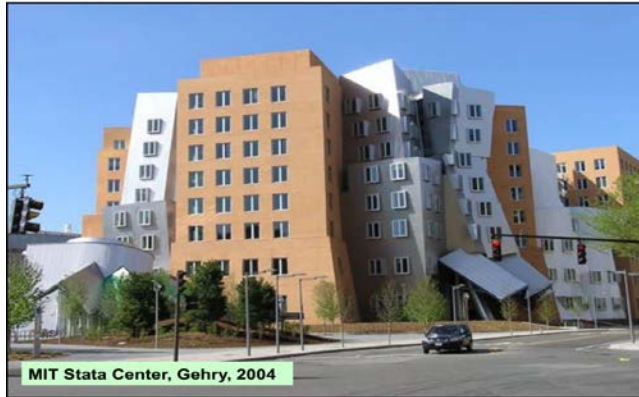

Image source:
<https://www.buildingscience.com/documents/digests/bsd-200-low-energy-commercial-institutional-buildings-top-ten-smart-things-to-do-cold-climates>



Unfortunately, buildings rarely just have nice flat, solid walls.

Occupants like to have access in and out of a building (**doors**), and natural light and views (**windows**).

And then we add the aesthetically interesting stuff...



<https://www.designingbuildings.co.uk/>

Images compliments of John Straube unless noted otherwise

We have to find ways to make smart choices as designers
so that we don't dream up buildings
that are impossible to insulate...



<https://fashionisers.com/>

If the image on the left doesn't make sense, what business do we have building facades that do fundamentally the same thing?

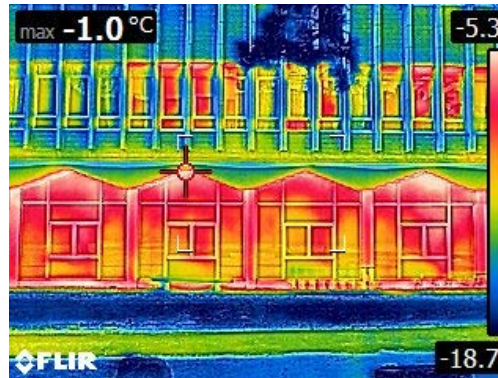

https://www.flickr.com/photos/lu_/28399247360

Exfiltration / Air Leakage

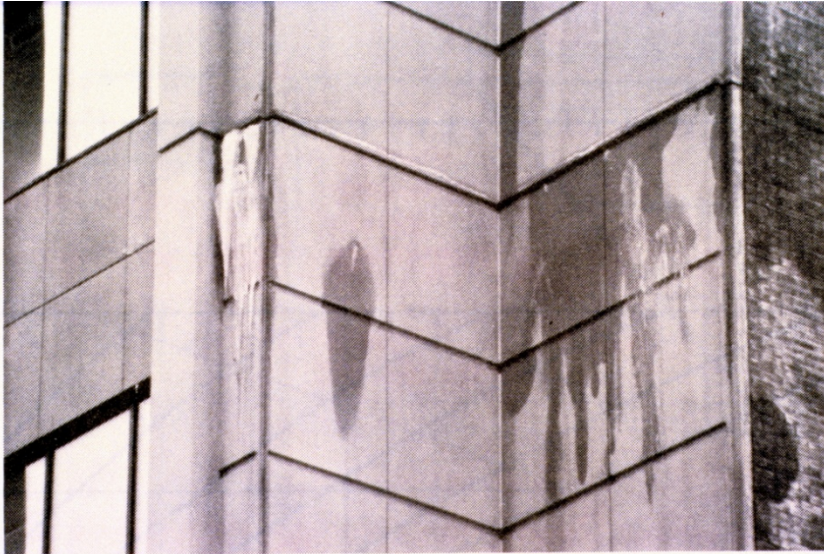

Figure 2.10 Exfiltration/Condensation



Fig. 15 Example of air leakage on the side of a building

In addition to heat flowing out of our buildings, we also need to make sure that air and moisture vapour do not make their way through the building envelope as when the temperature drops, air vapour reaches its DEW POINT and condenses, damaging the wall.

Through WALLS vs. through cracks



Water **VAPOUR** can be carried **THROUGH** the walls, like a **GHOST**.

This is called **VAPOUR DIFFUSION**.

Evidenced sometimes by **EFFLUORESCENCE** (the white salty stuff on the brick above).

© 2002 Scott Lefton

...vs. through CRACKS



When water vapour is carried in the AIR and escapes THROUGH THE CRACKS this is termed **AIR LEAKAGE**.

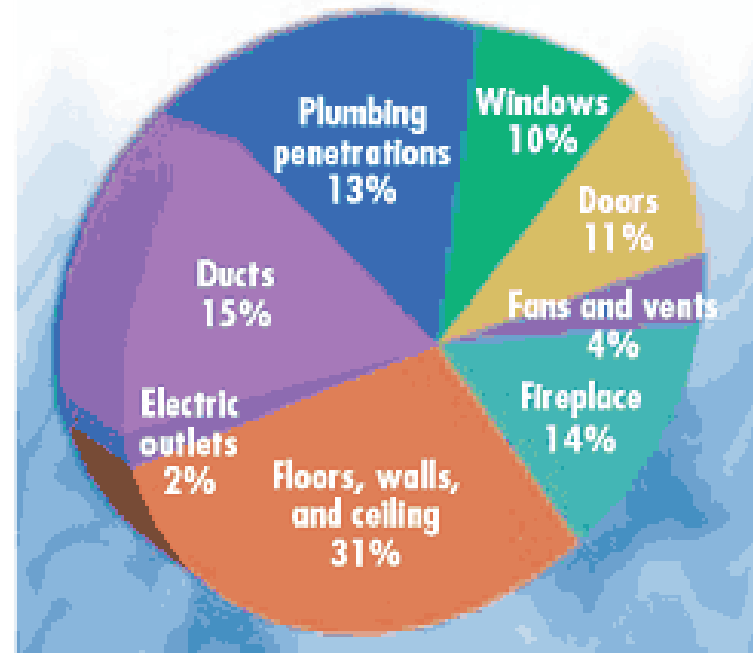

How Does the Air Escape?

Air infiltrates in and out of your home through every hole, nook, and cranny. About one-third of this air infiltrates through openings in your ceilings, walls, and floors.

Air leakage paths in houses

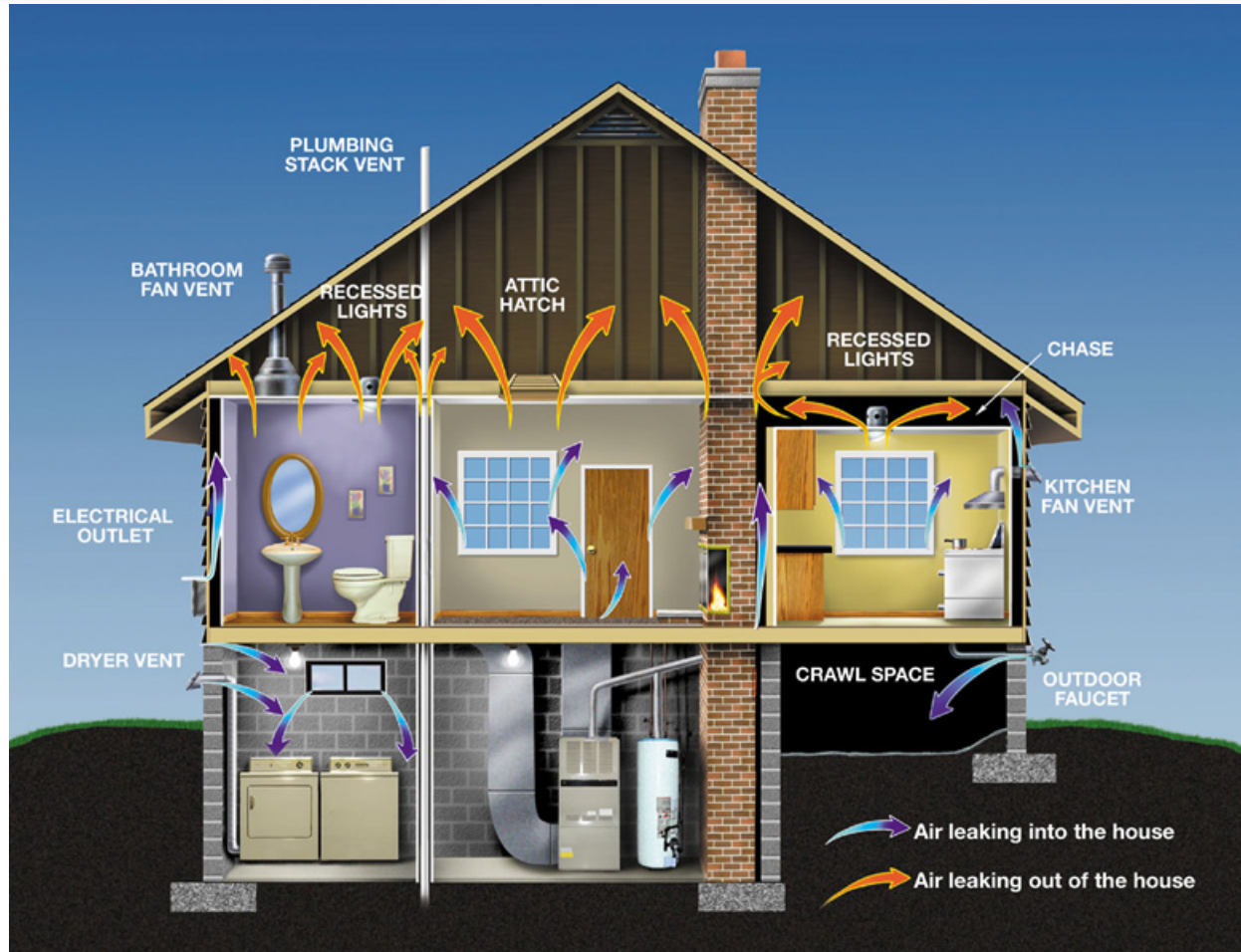

A moist interior environment



All of these factors put moisture into the air that is trying to escape via **Diffusion** or **Exfiltration (ghosts and cracks)**.

The moisture ends up condensing **IN the building envelope...**



Vapour barriers

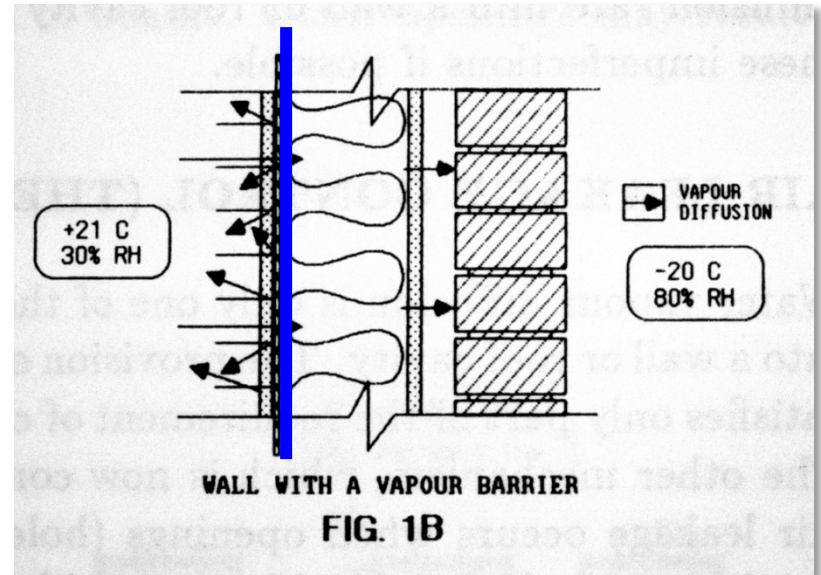
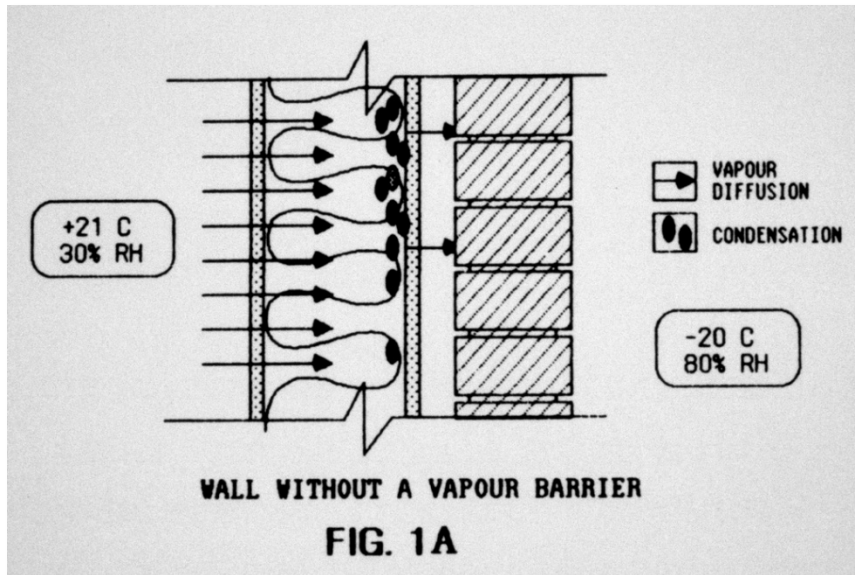

The vapour barrier (in this instance made from 4mil polyethylene film) is placed on the **WARM SIDE OF THE INSULATION**. It stops the GHOST-like vapour from passing THROUGH THE WALL.

Only about 10% of vapour escapes through the wall in this manner. 90% of the problem is as a result of AIR LEAKAGE through the cracks.

Problems with vapour barriers

Polyethylene film that is used as a vapour barrier has some inherent problems arising from its fragility. It is easy to puncture and is not very durable.

There are studies being done at present that might indicate that it should not be used as widely as it is in walls for humid situations, as in some cases it is trapping moisture in the wall and CAUSING rot.

The jury is still out...

Ask Dr. John Straube when you have him in Arch 364...



Mold!!

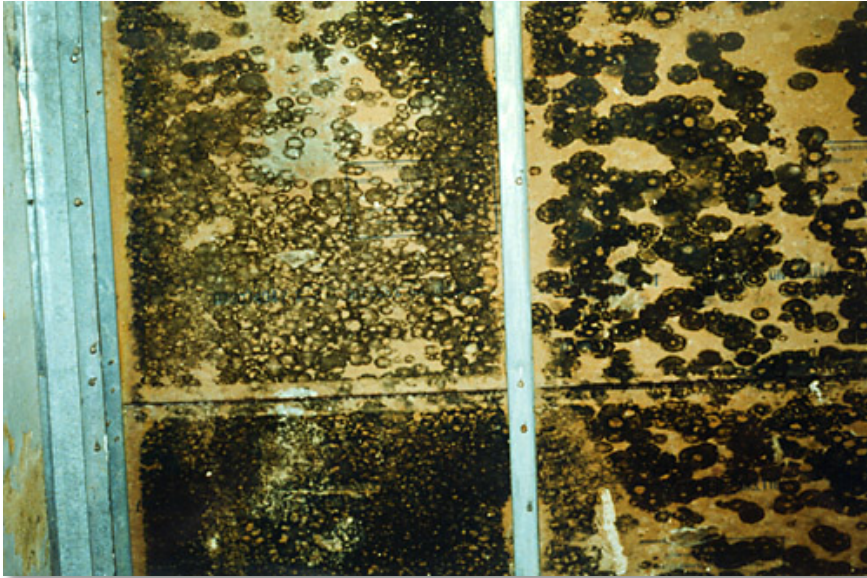

Mold is TOXIC
and very
expensive to
remediate.



Air barriers



A concrete wall is a good **air barrier** – but it does allow (some) vapour to pass through...

Much better than concrete block which is quite porous.

Air barriers are products or systems of products that keep **AIR** from passing through them (not vapour).



Controlling air leakage

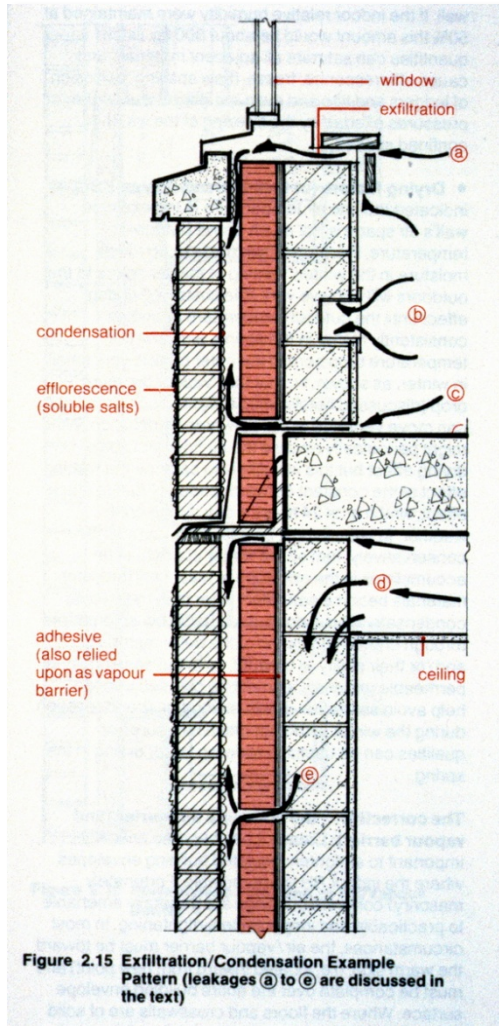

Building envelopes must be designed and detailed to prevent **VAPOUR DIFFUSION** as well as **AIR LEAKAGE**.

This means sealing up all of the **CRACKS** between elements of the building envelope system.

You seal **CRACKS** with an **AIR BARRIER**.

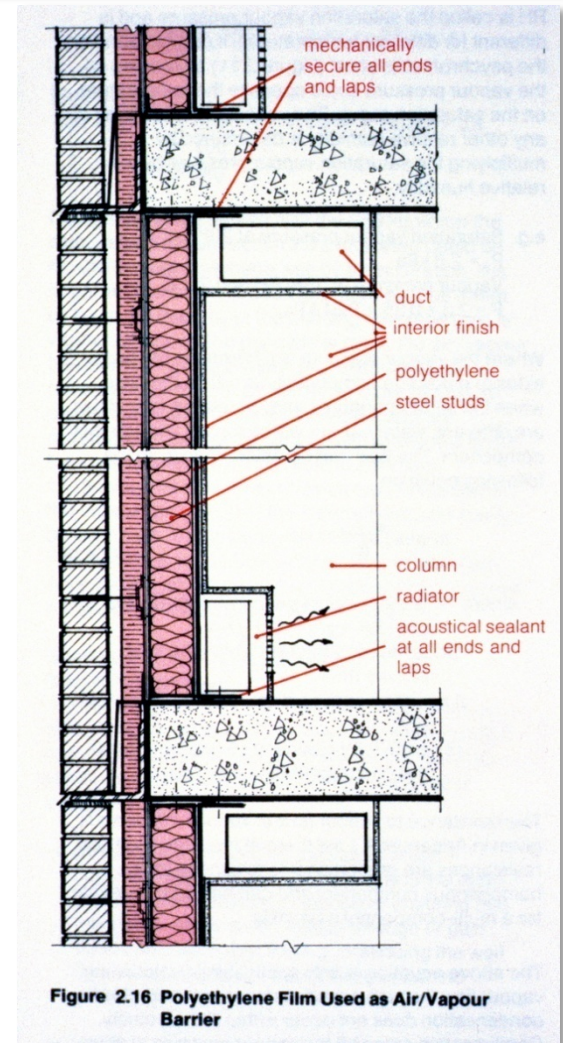

Humidity:

Whether in a cold or warmer climate, humidity remains one of the most potentially devastating forces that can cause degradation to the building envelope.

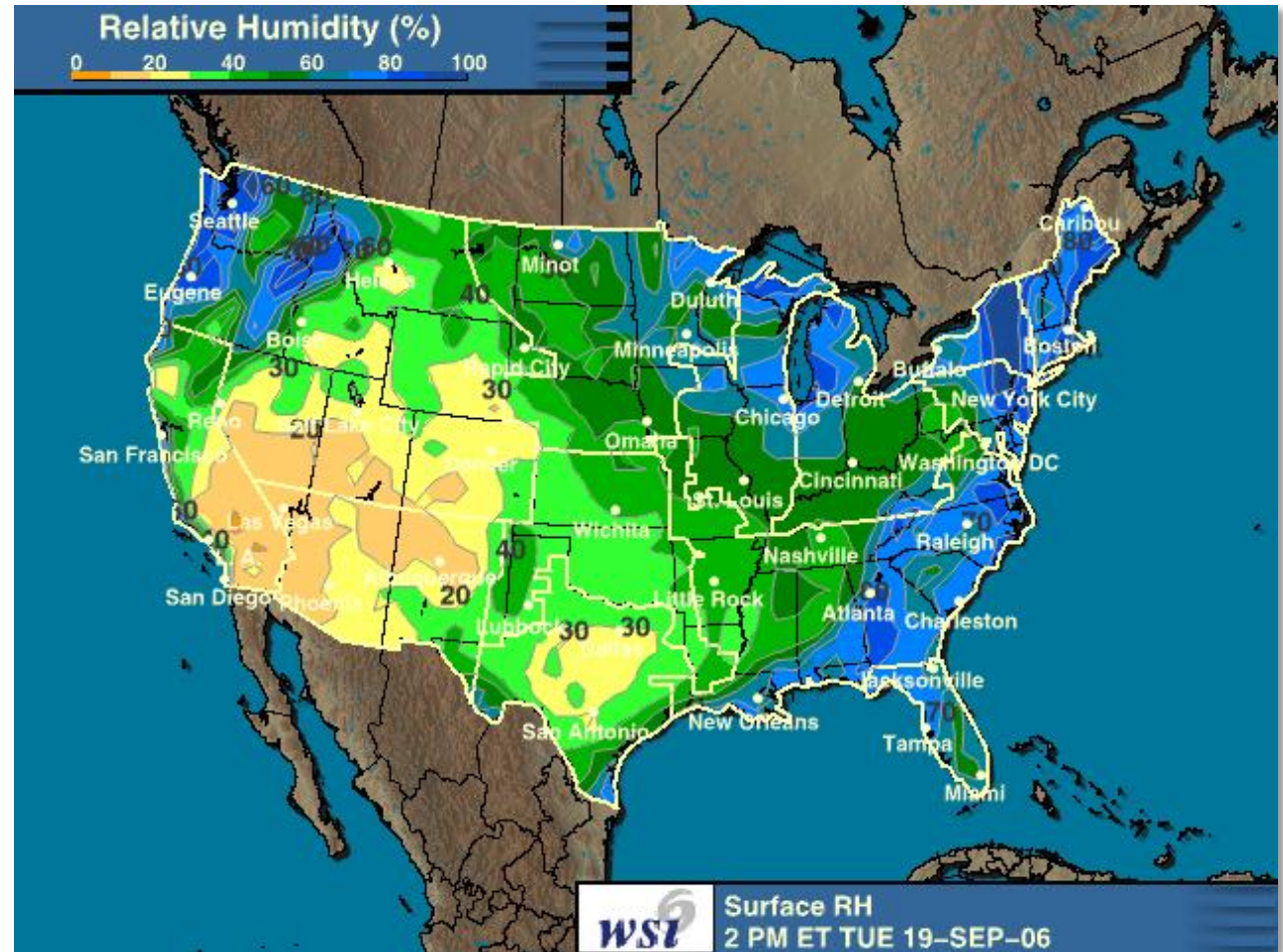

Acid rain

Acid Rain Formation

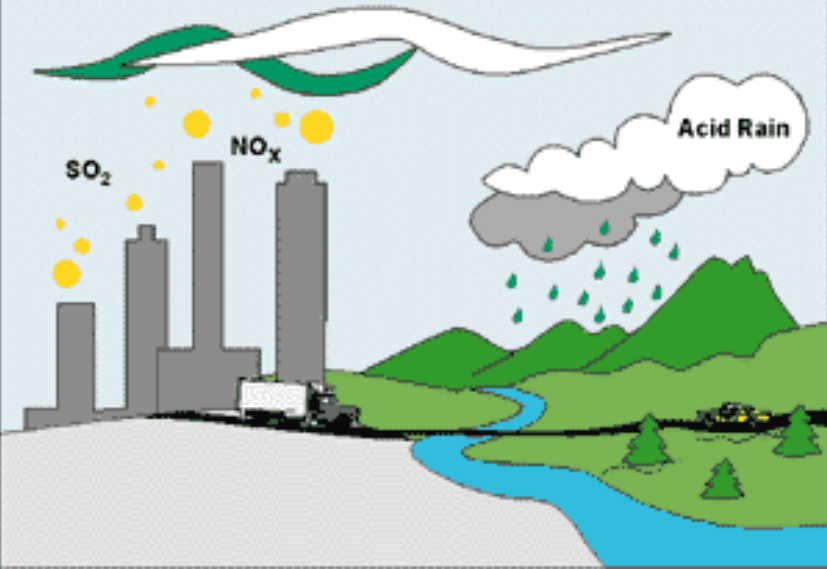

Acid Rain Formation

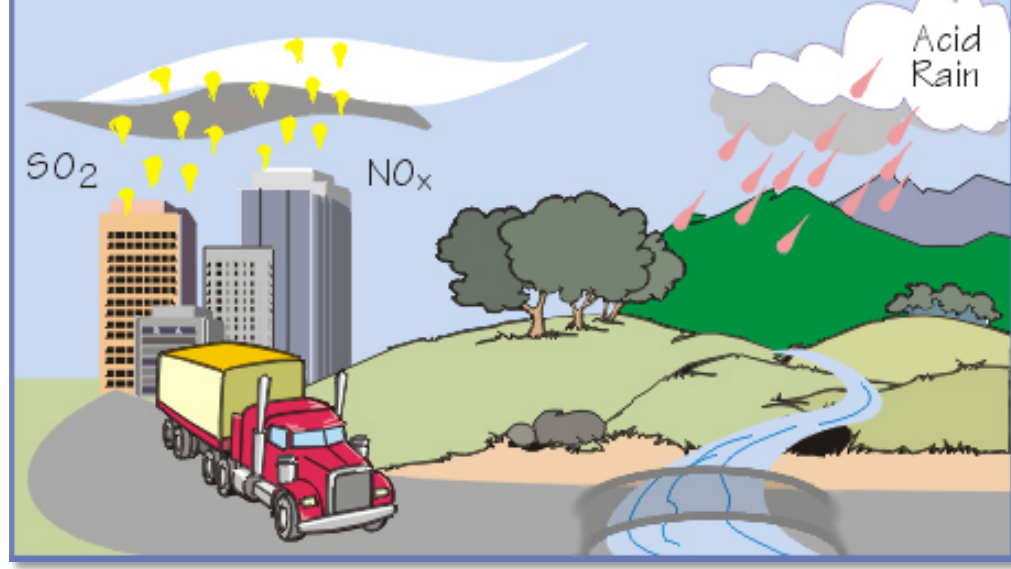

Acid rain not only affects the integrity and functionality of our rivers, lakes and streams, but also can degrade our building envelopes, causing either deterioration or unsightly staining. The sculptural elements on many old cathedrals in Europe are losing their detail due to acid rain erosion.

Staining of buildings

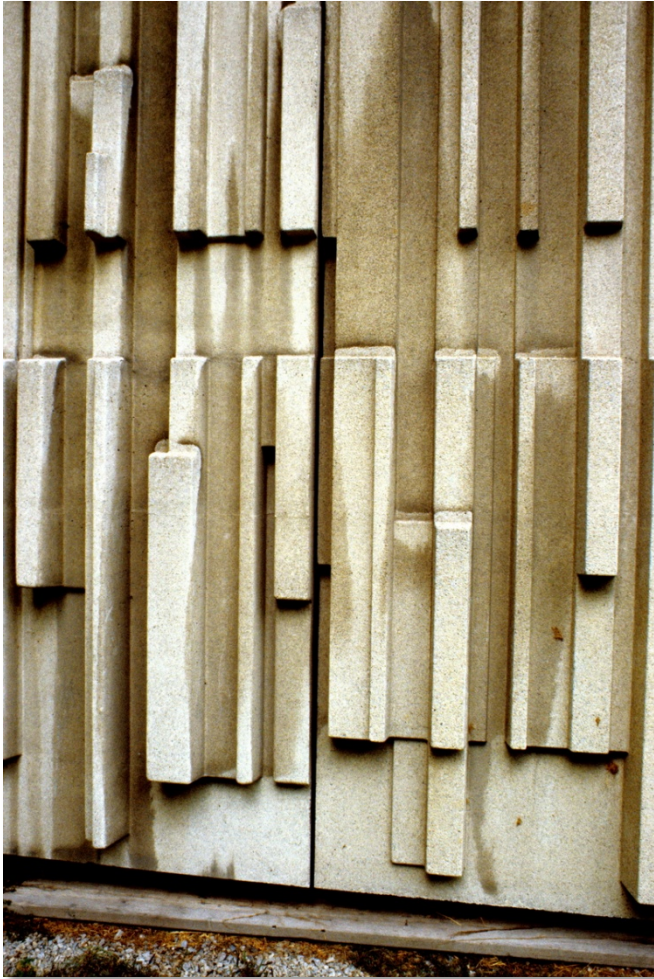

The Medical Arts Building at University of Toronto – showing the effects of acid rain/ polluted air on the precast concrete cladding.

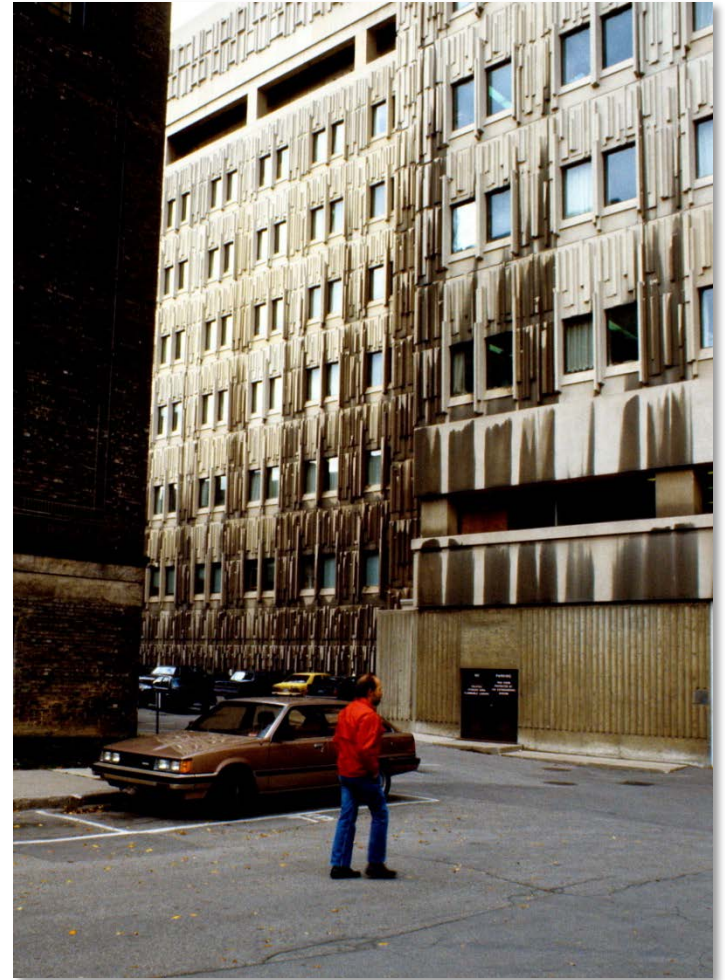

Wind



Wind can be a very positive force in the built environment, giving us natural ventilation and energy for our buildings.



Wind damage



However building envelopes must be designed to resist extreme wind forces, particularly in hurricane and tornado prone areas.





Wind over a small building

The effects of wind on low rise buildings will have ramifications on the design of roofs (and selection of roofing materials to prevent uplift), as well as ventilation patterns through openings/windows.

Recognize positive pressure on the windward side and negative/suction pressure on the leeward side of the building.

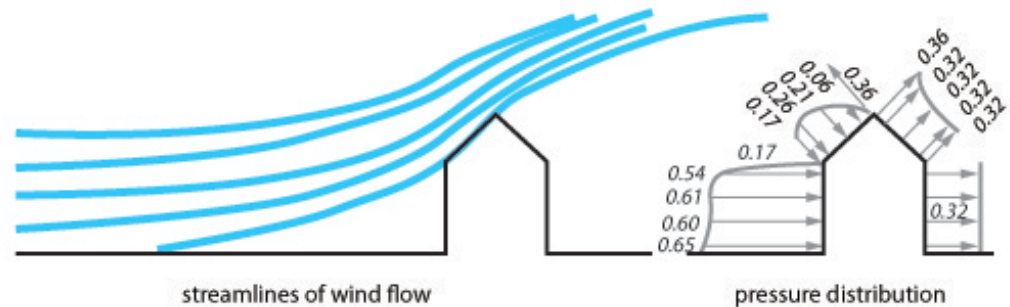

two-dimensional wind flow over a building.

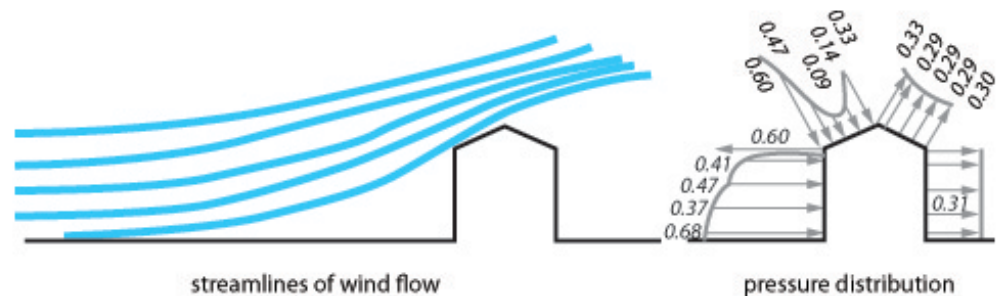

separation of wind flow at eave causing high suction.

Wind speeds

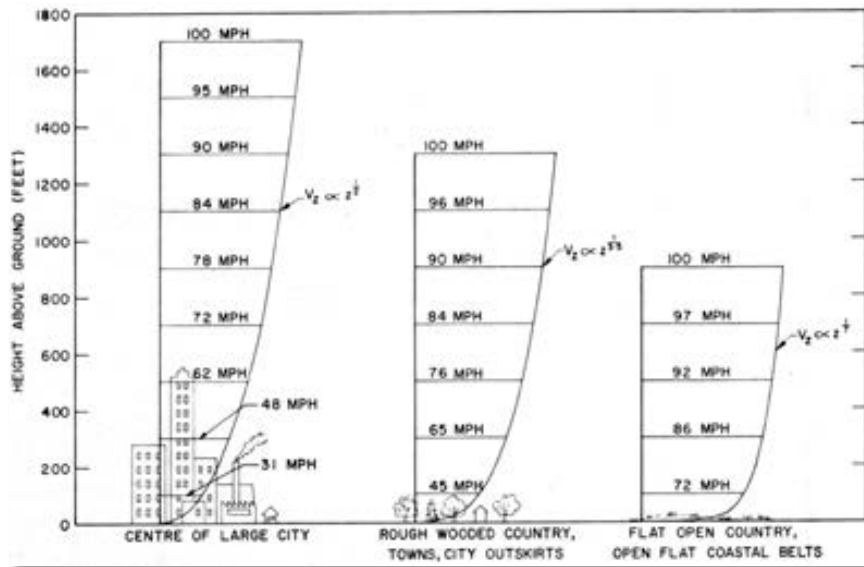

Wind speeds vary as a function of the “openness” of the space.

Ground level winds speeds are higher in open country, but tall buildings experience severe wind loads on their upper stories that can put extra pressure on the building envelope.

January Wind Wheel/Rose for Toronto

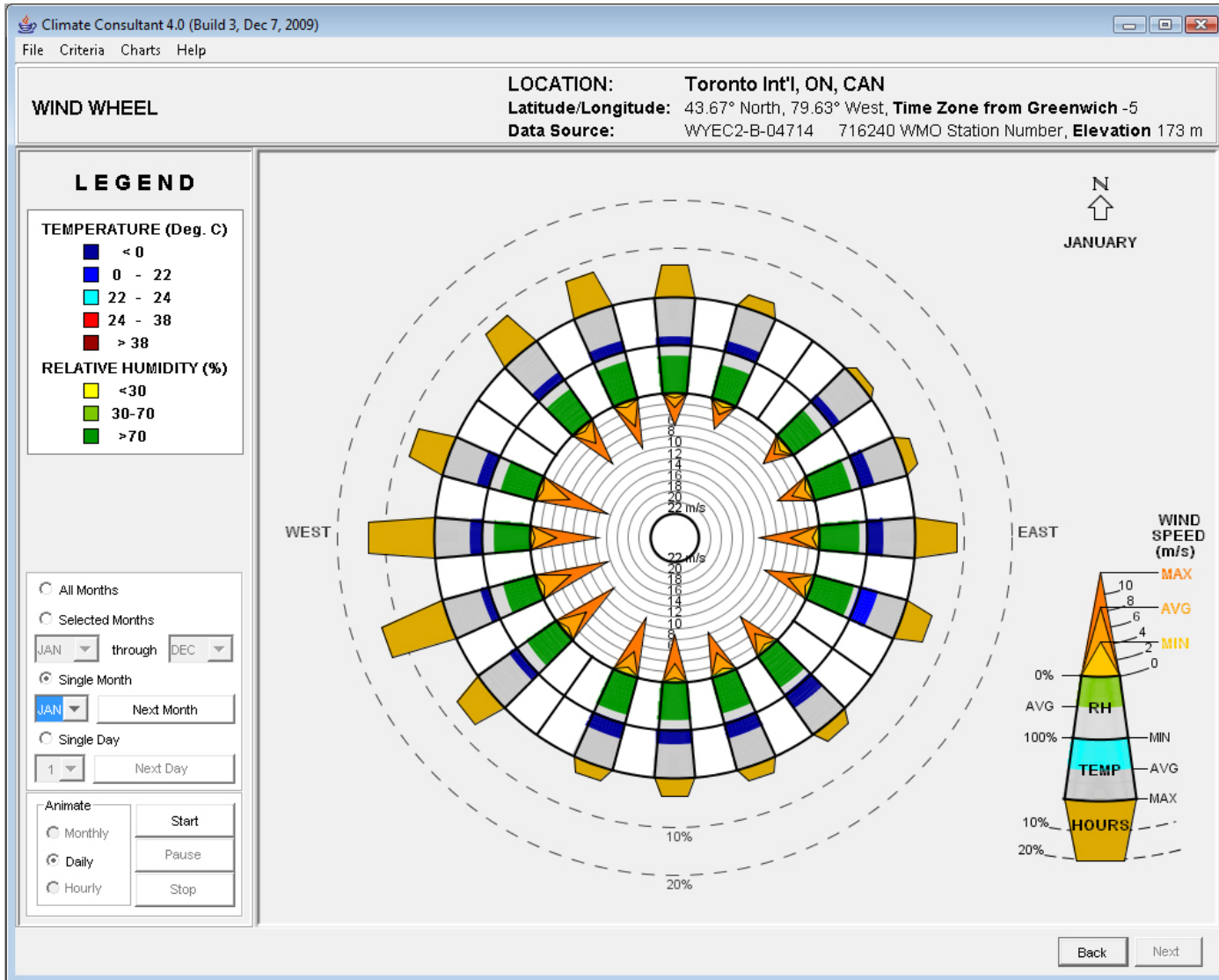

July Wind Wheel/Rose for Toronto

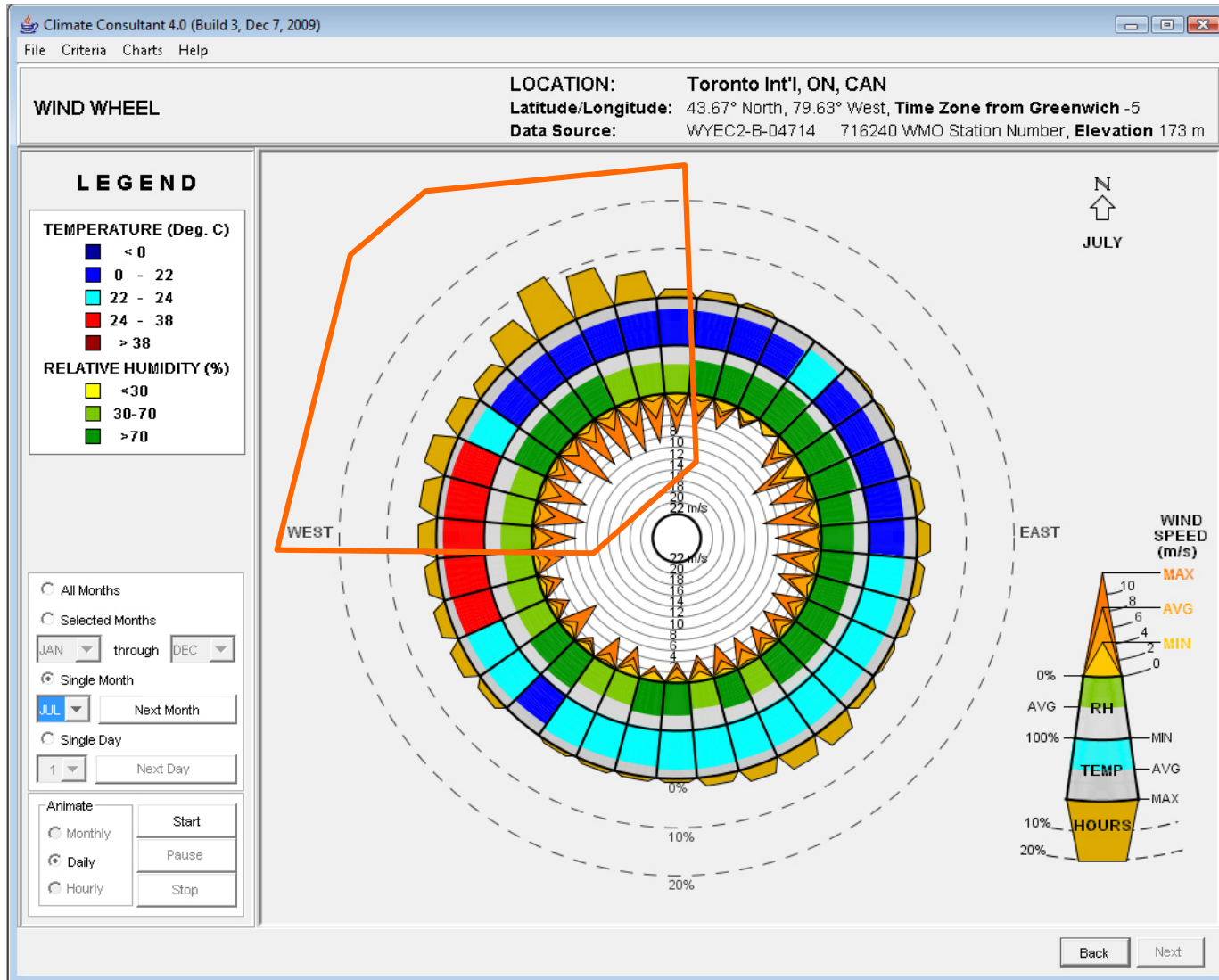

September Wind Wheel/Rose for Toronto

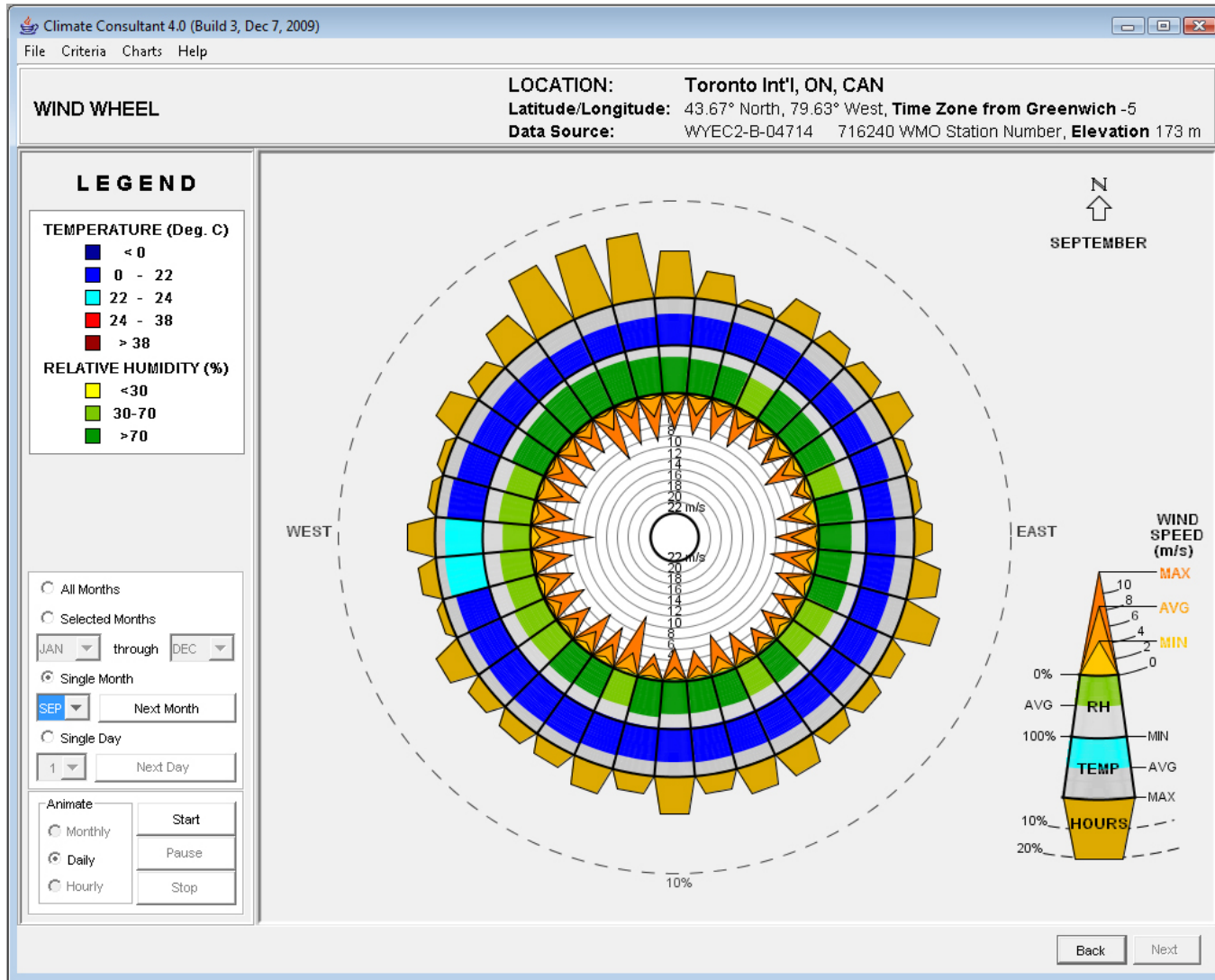

Wind around a tall building

Wind forces around very tall buildings can be severe. There is upward wind flow at the top of the building and downward flow at the base. Turbulence at ground level can make it difficult to open and close doors.

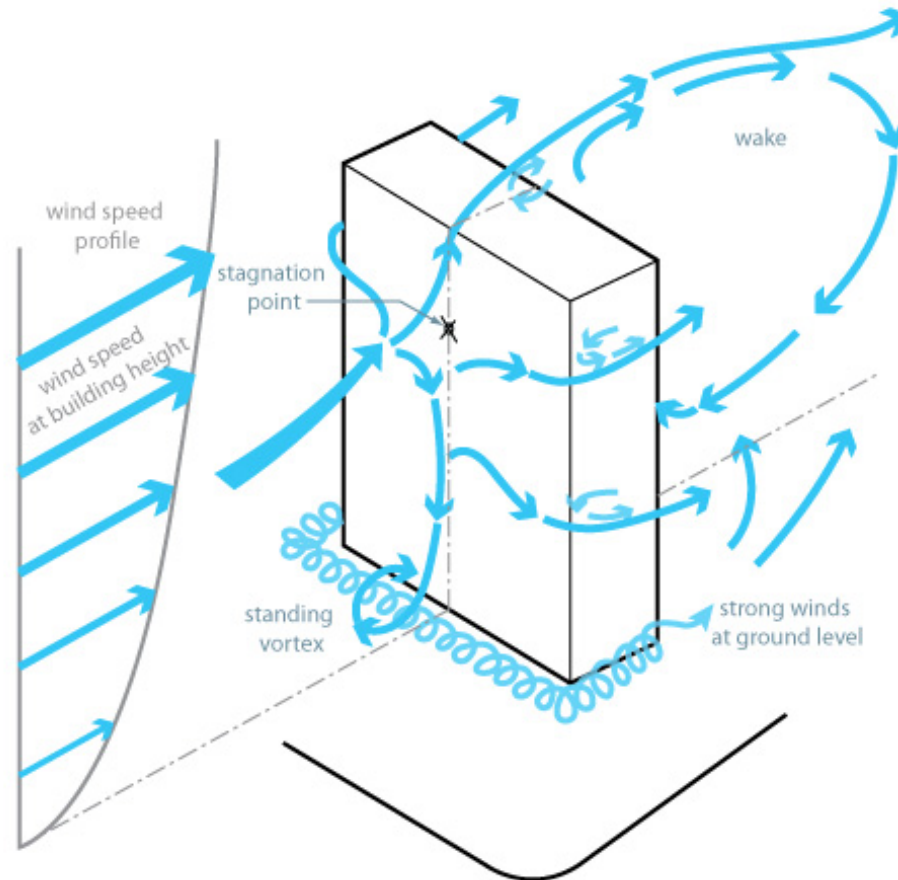

Flow around a building in a boundary layer.

Swiss Re by Foster + Partners

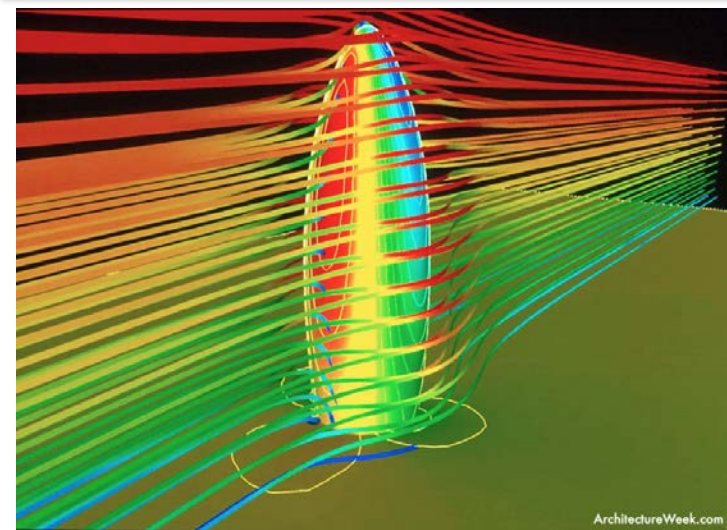
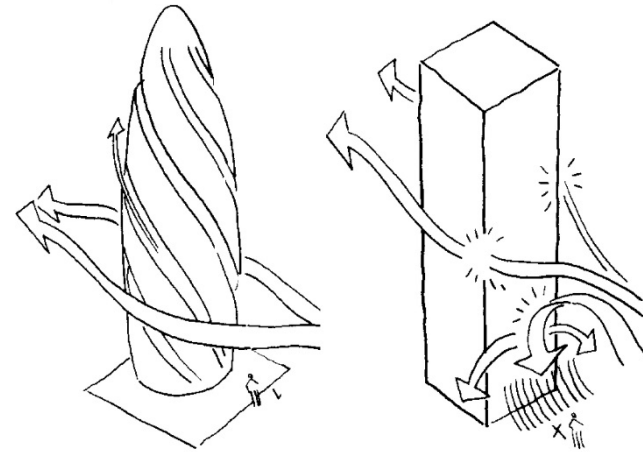

Building designed as a round tower to make for a less hostile wind regime at the base.

Sometimes the Met Data is Lacking

- Burj Khalifa – 820 m tall
- Wind measured at ground level is not good enough

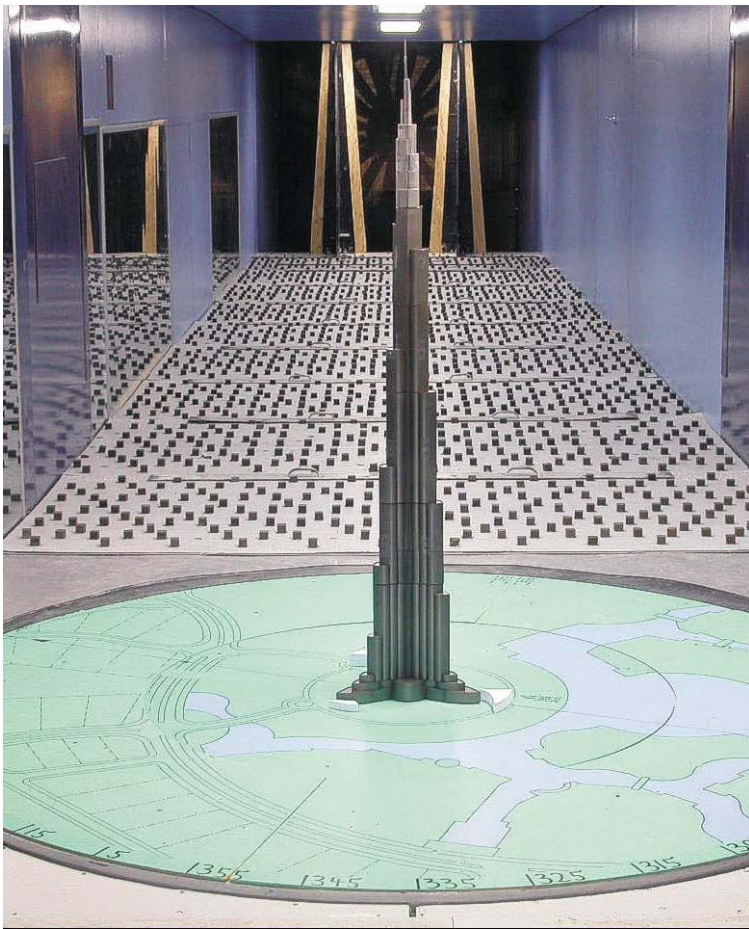

Wind Profile

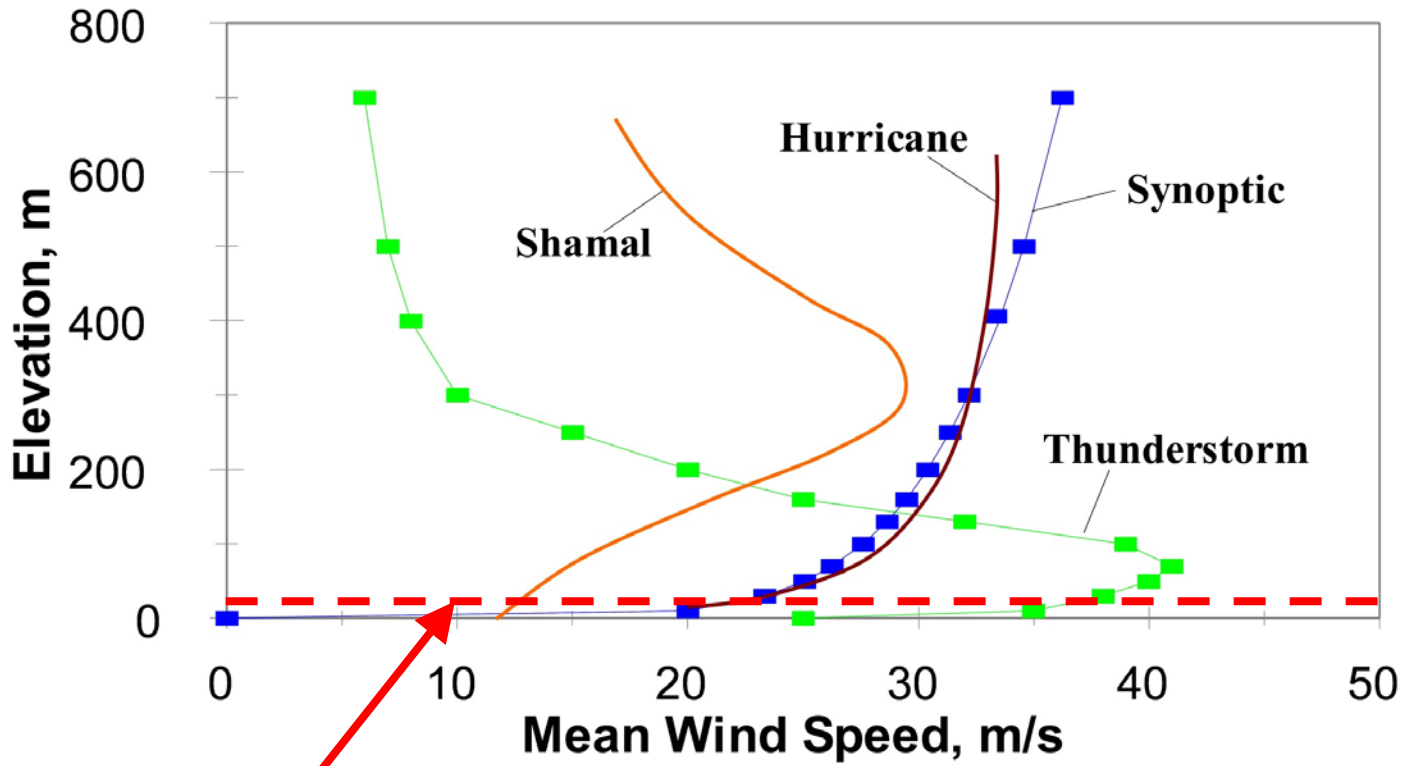

Historical wind data recorded at surface level

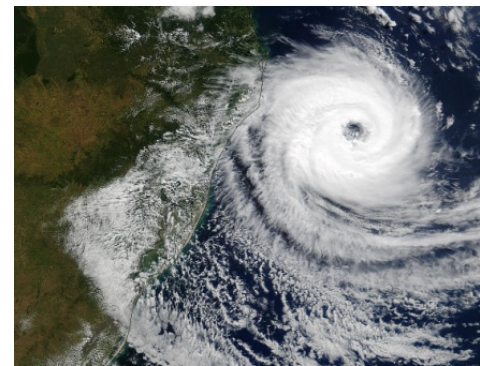
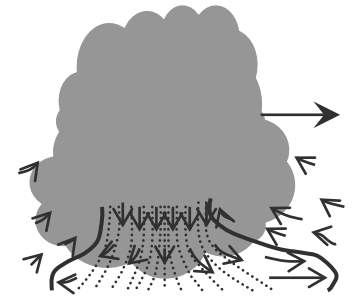

Sometimes the Met Data Is Not Valid

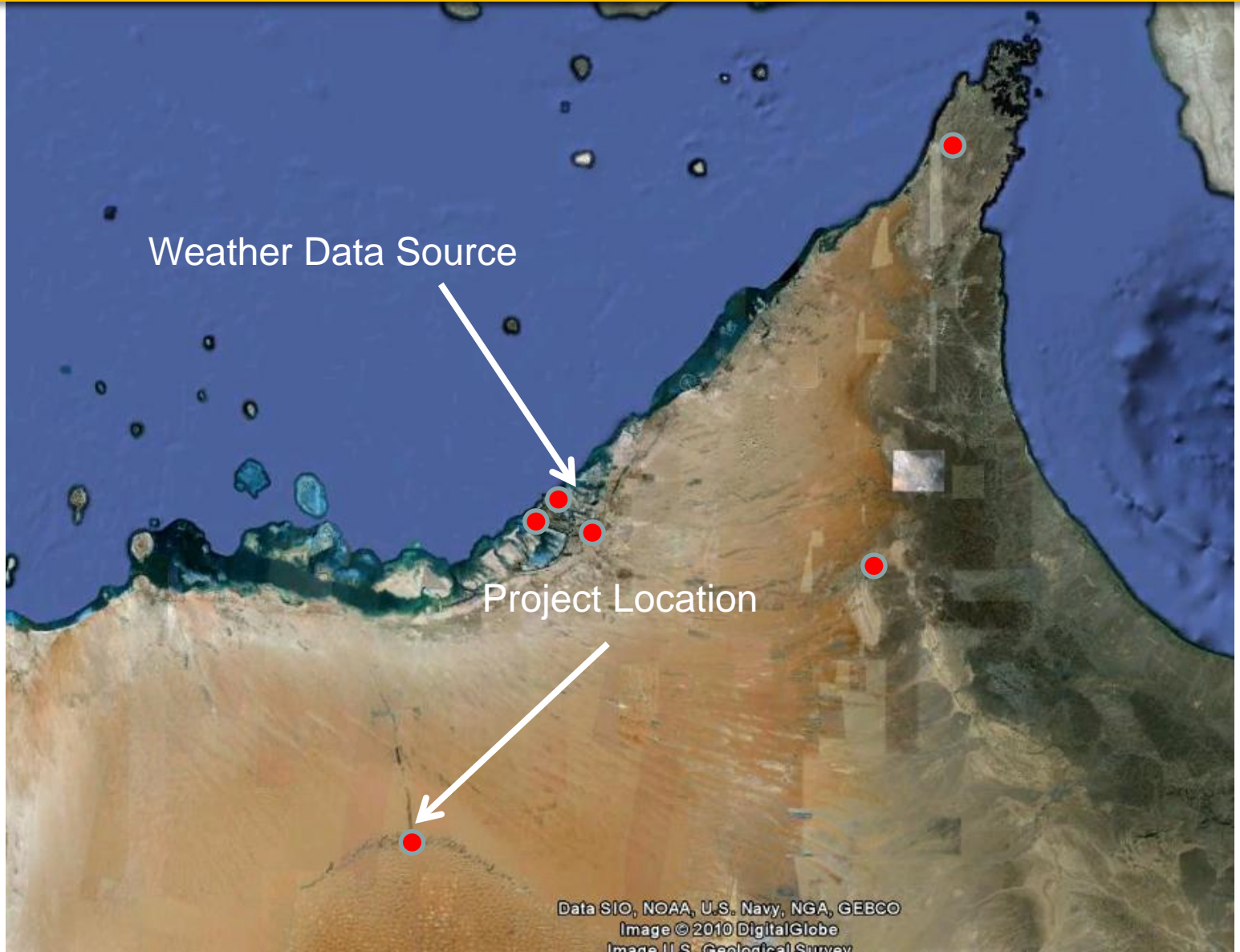

Sometimes the Met Data is Just Wrong

Location of wind instrument



Study of UAE

- Client needed higher fidelity of meteorological data
- Prognostic model used to replicate local conditions.
- Modeling also used to assess planned land use changes and climate change.

Wind & Temperature Fields

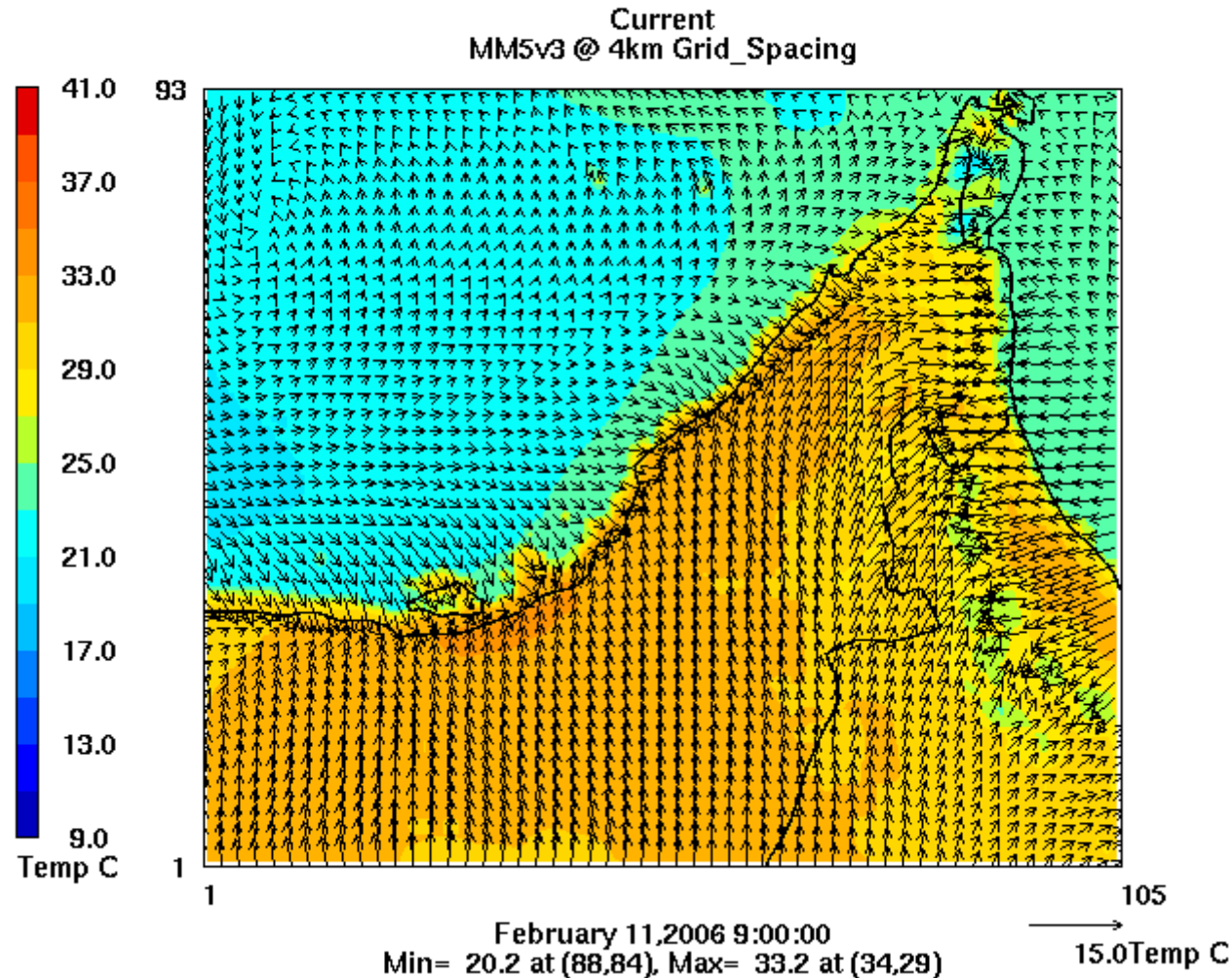

Wind Tunnel



Wind Tunnel

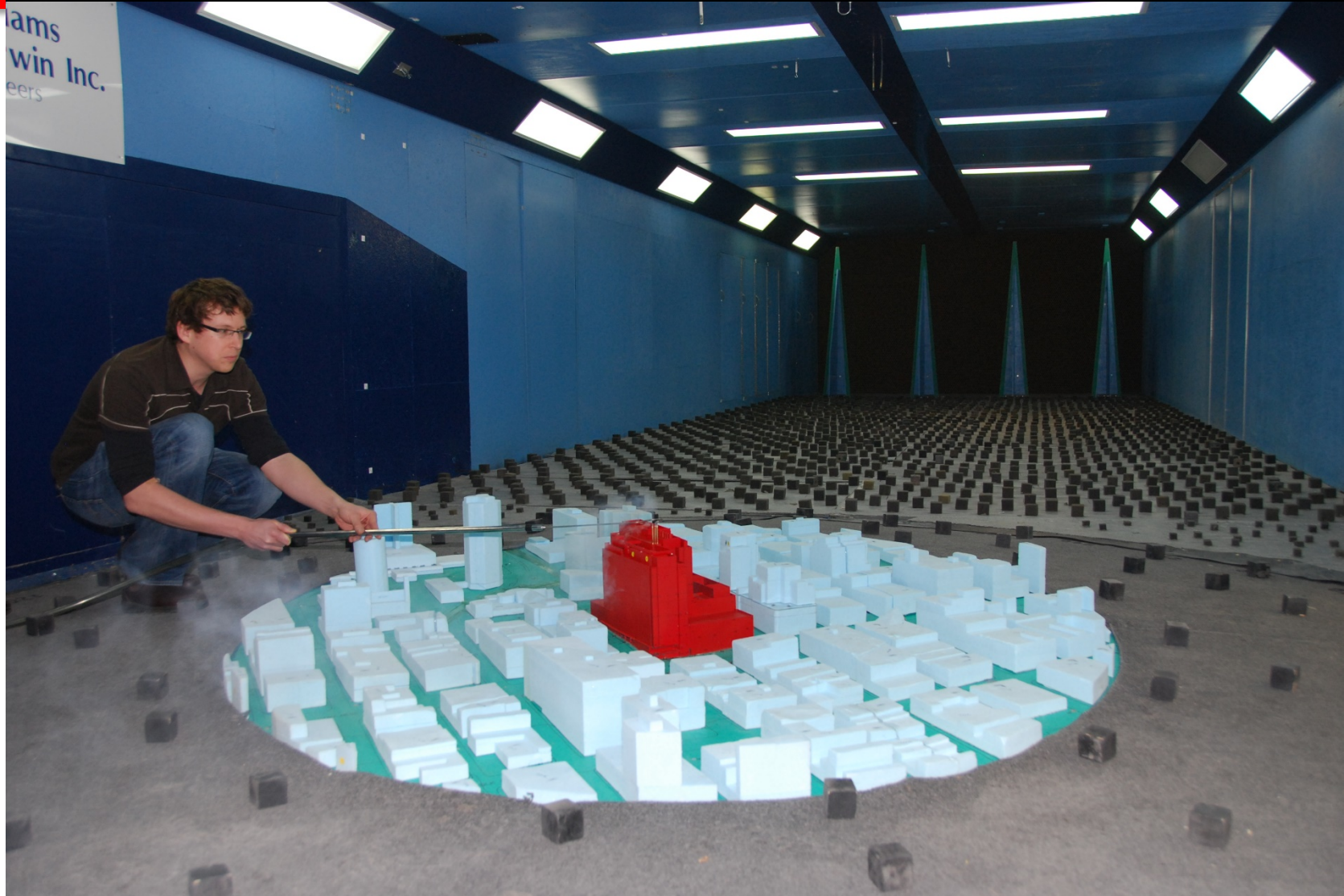

Wind Tunnel

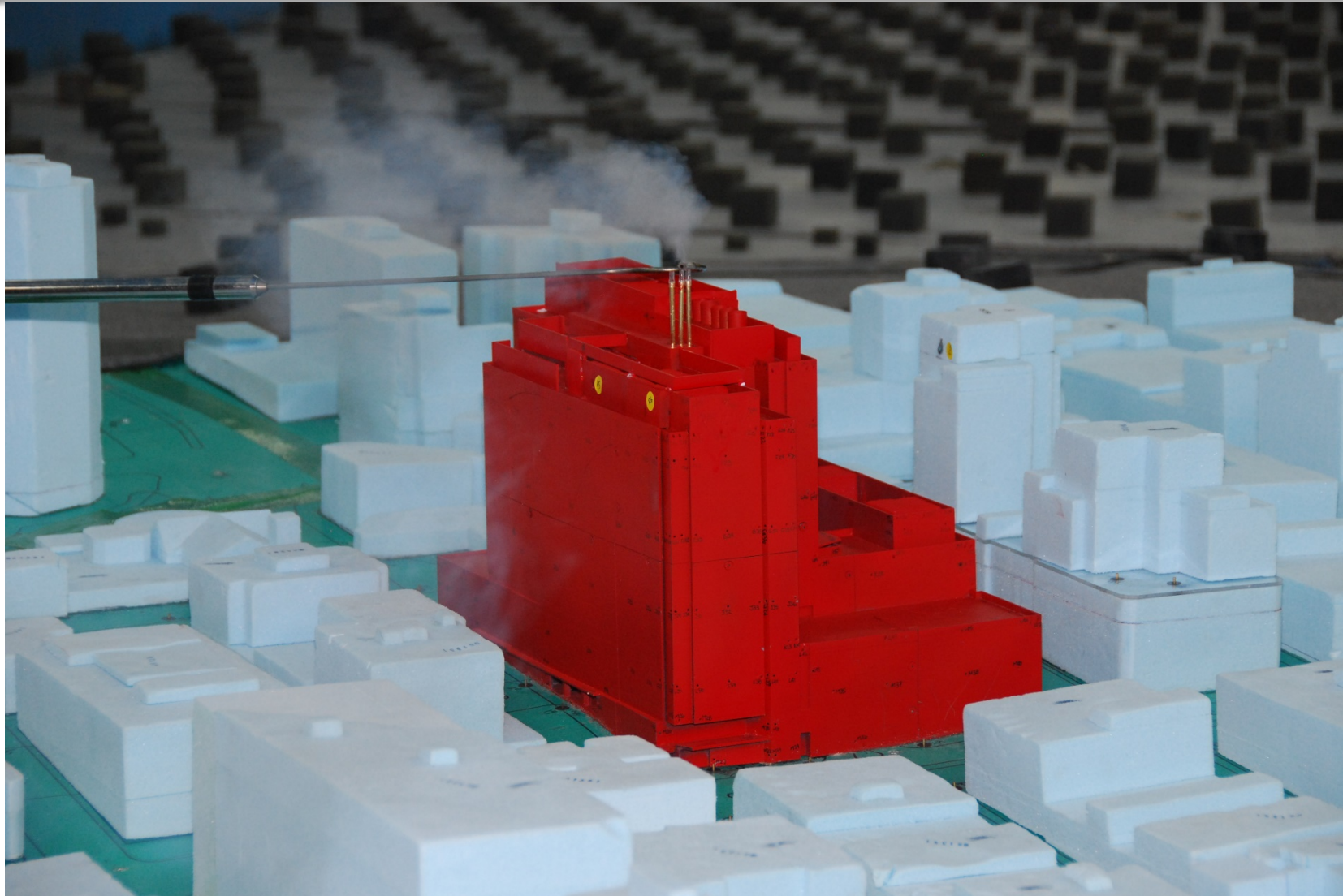

Wind Tunnel

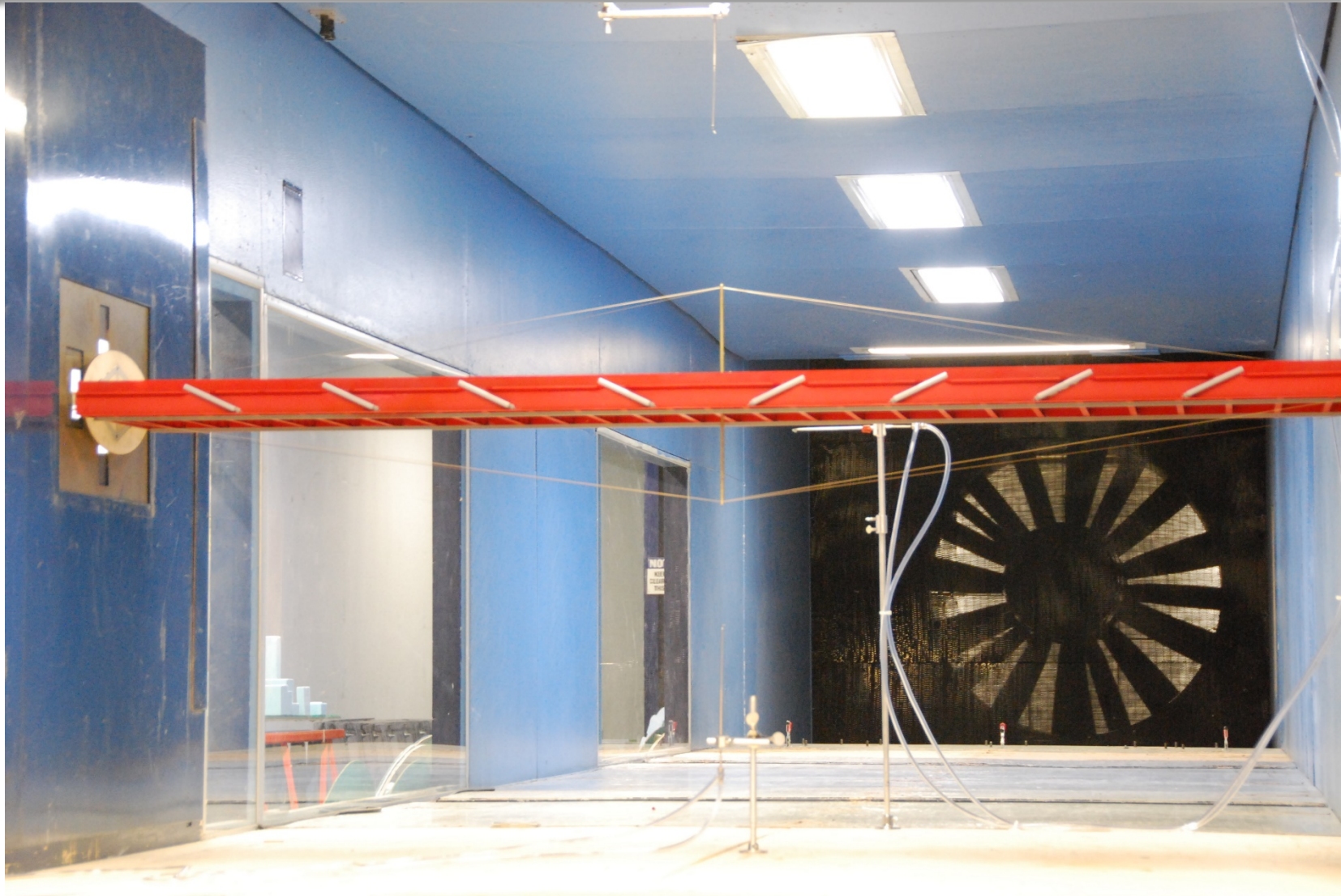

Wind tunnel model

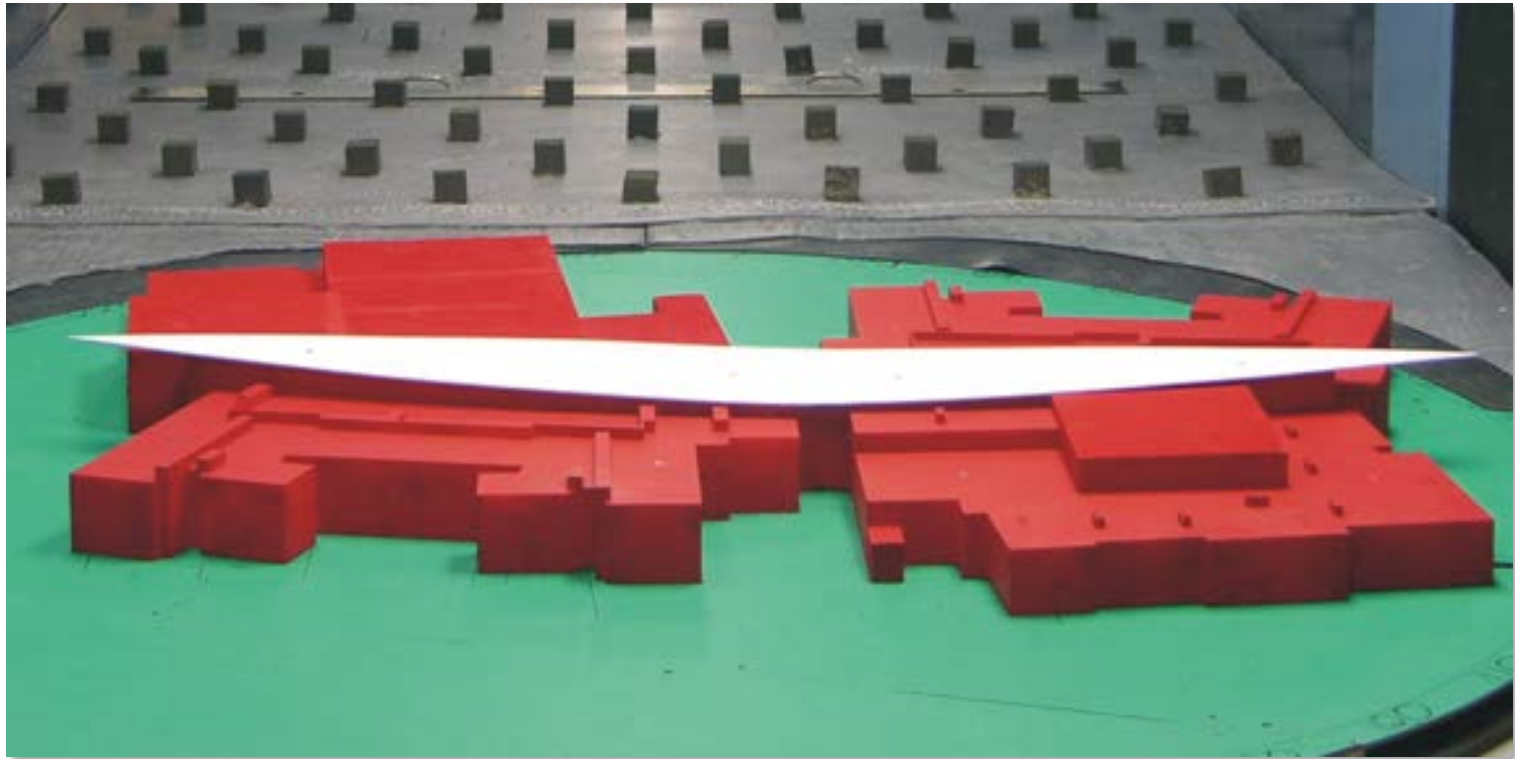

Windtunnel Measurements

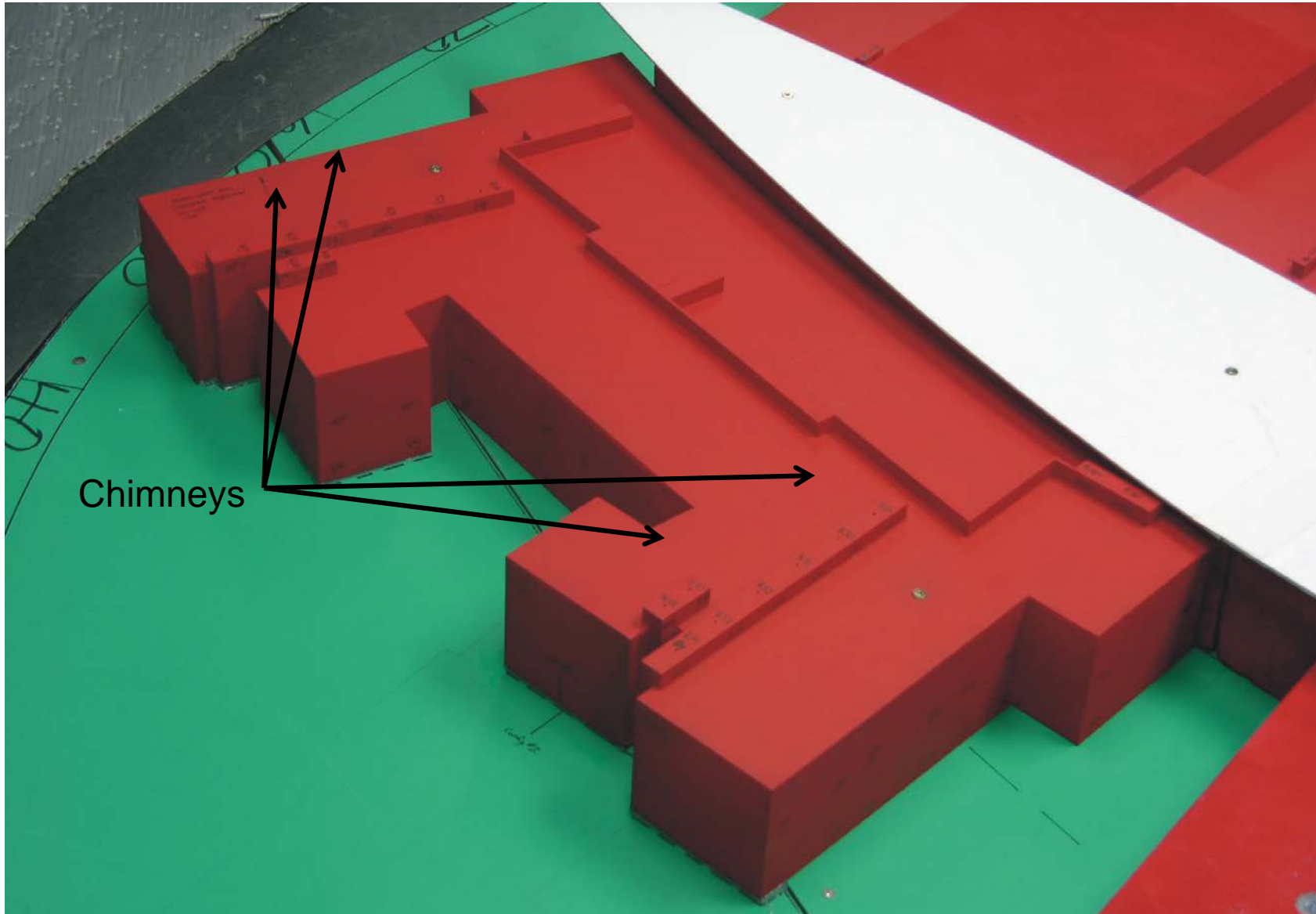

Chimneys

Urban situation easy to check



Models for the Leadenhall Building that include Swiss Re, previously modeled + site condition at base of buildings

Model Shop



Specially constructed models

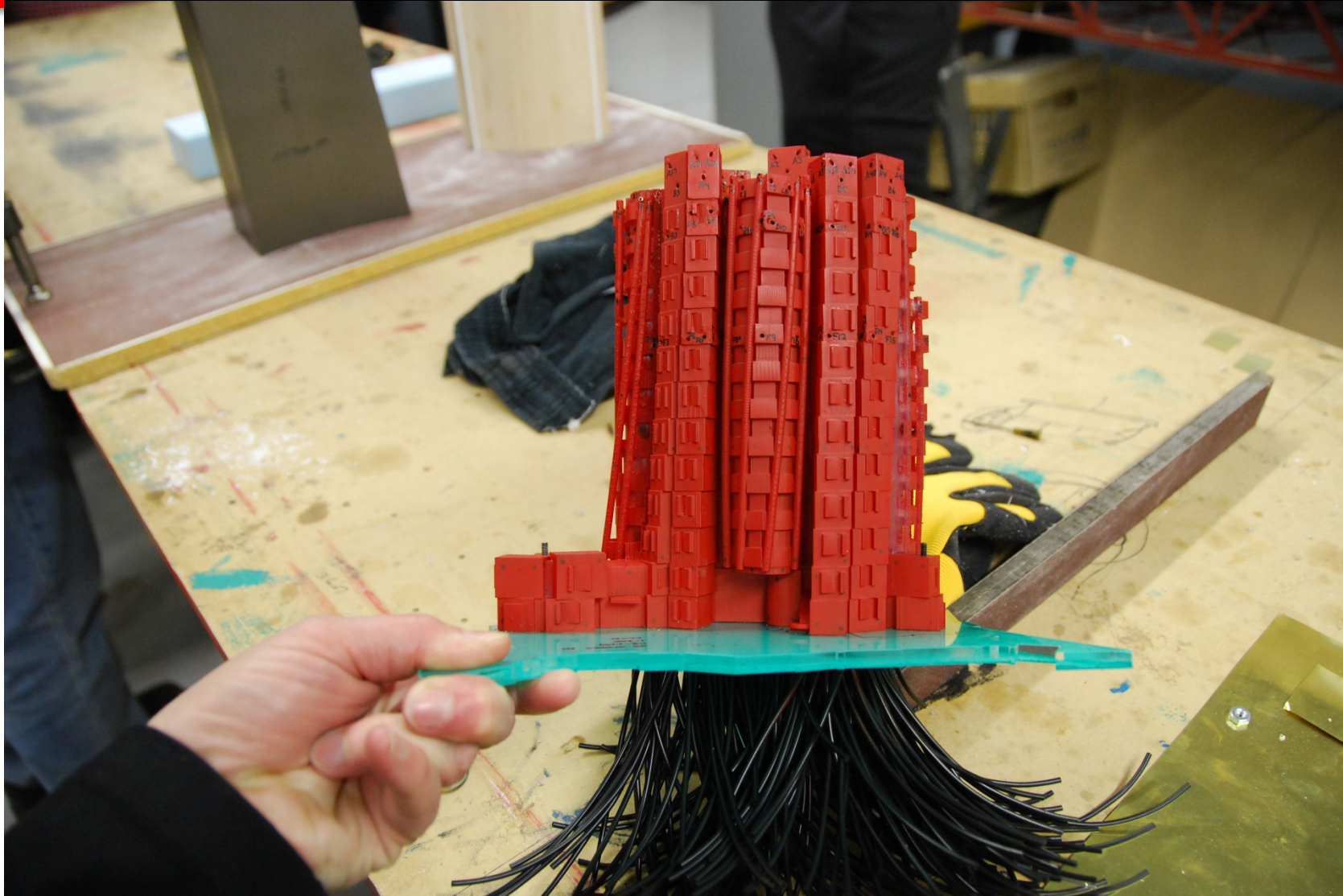

World class facility

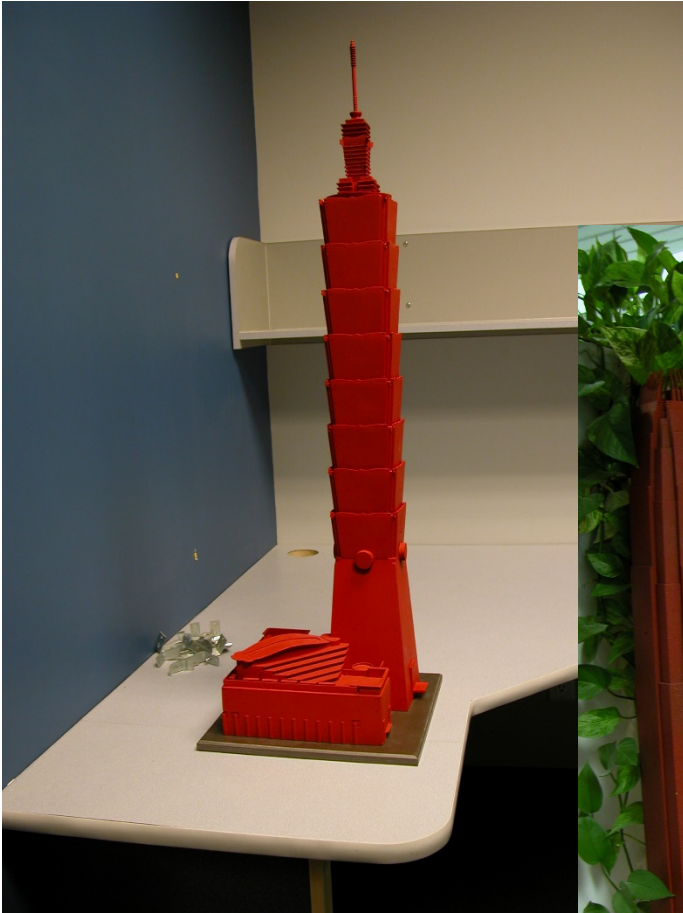

Stack effect

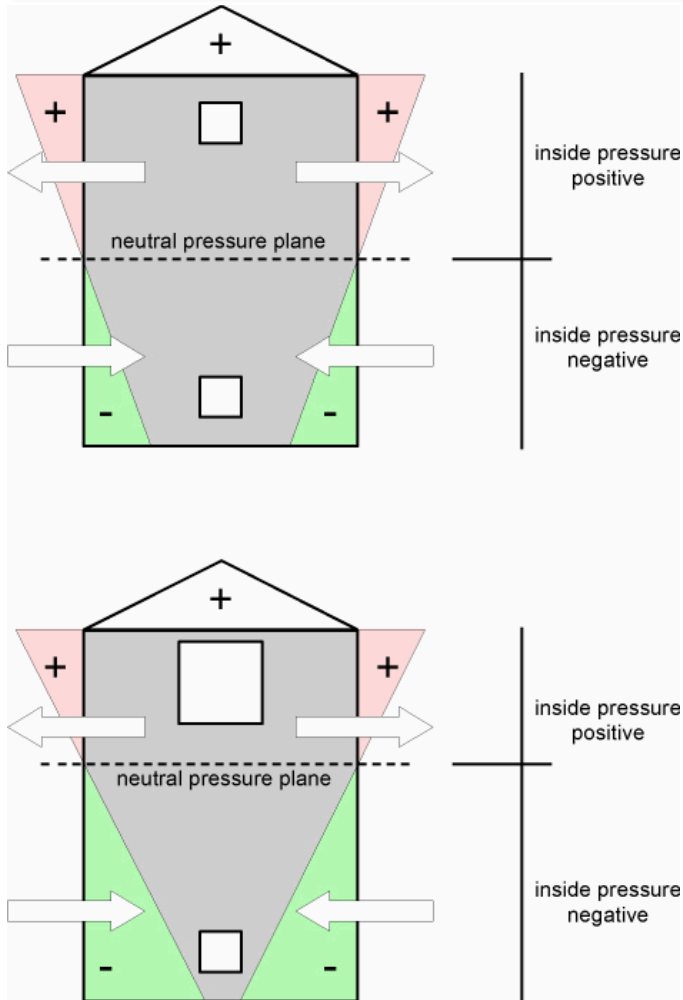

11 / AIR LEAKAGE AND VENTILATION

269

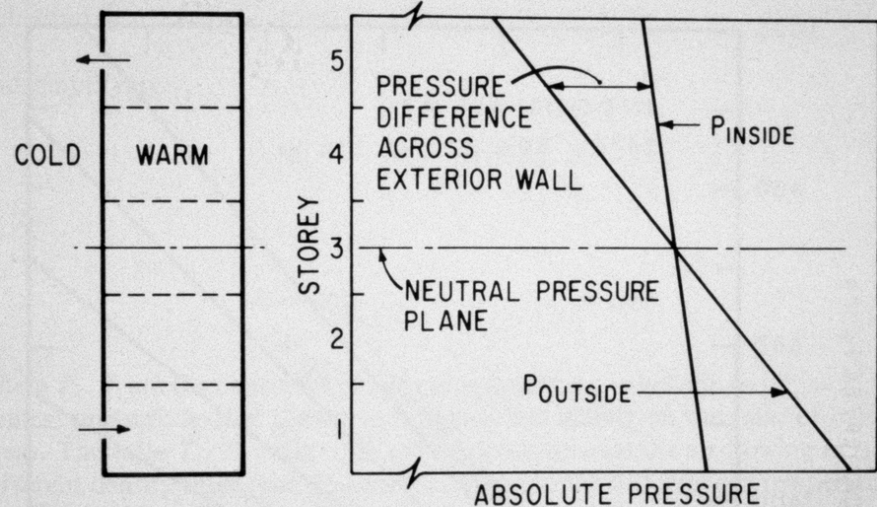

FIGURE 11.2 Stack effect in a building with no internal partitions. (From Wilson, A.G., and Tamura, G.T., Canadian Building Digest 104, DBR/NRCC, 1968, Fig. 1(b))

Stack effect is caused by the nature of hot air to rise. It puts upward/outward pressure at the top of a building and suction/inward pressure at the base.

The issue of snow



Certain roof shapes are more prone to snow buildup and can reduce the ease of insulation.



Odd shaped buildings like the AGO by Frank Gehry are not immune to difficult snow accumulation.

Water Flume



Water Flume

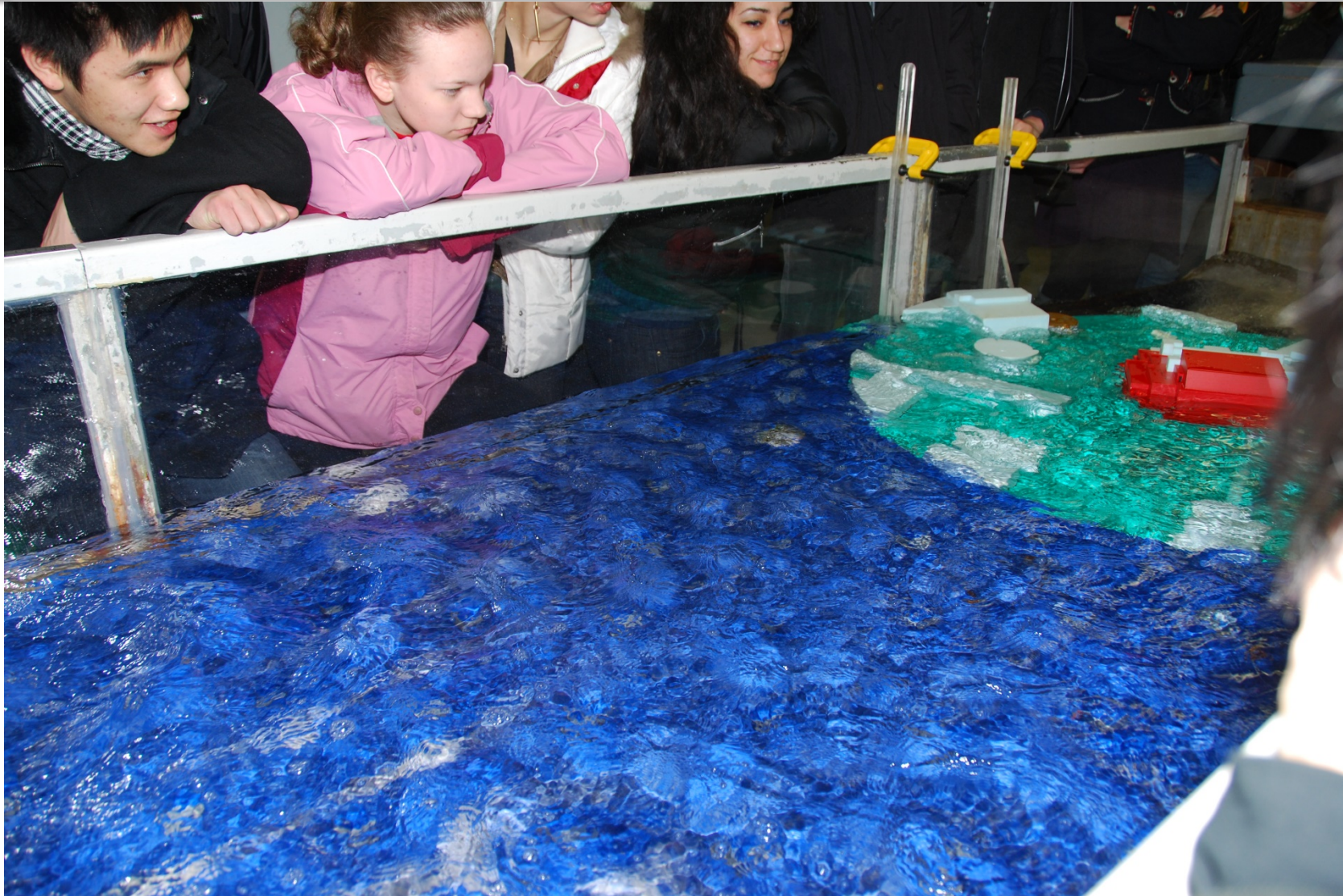

Water Flume

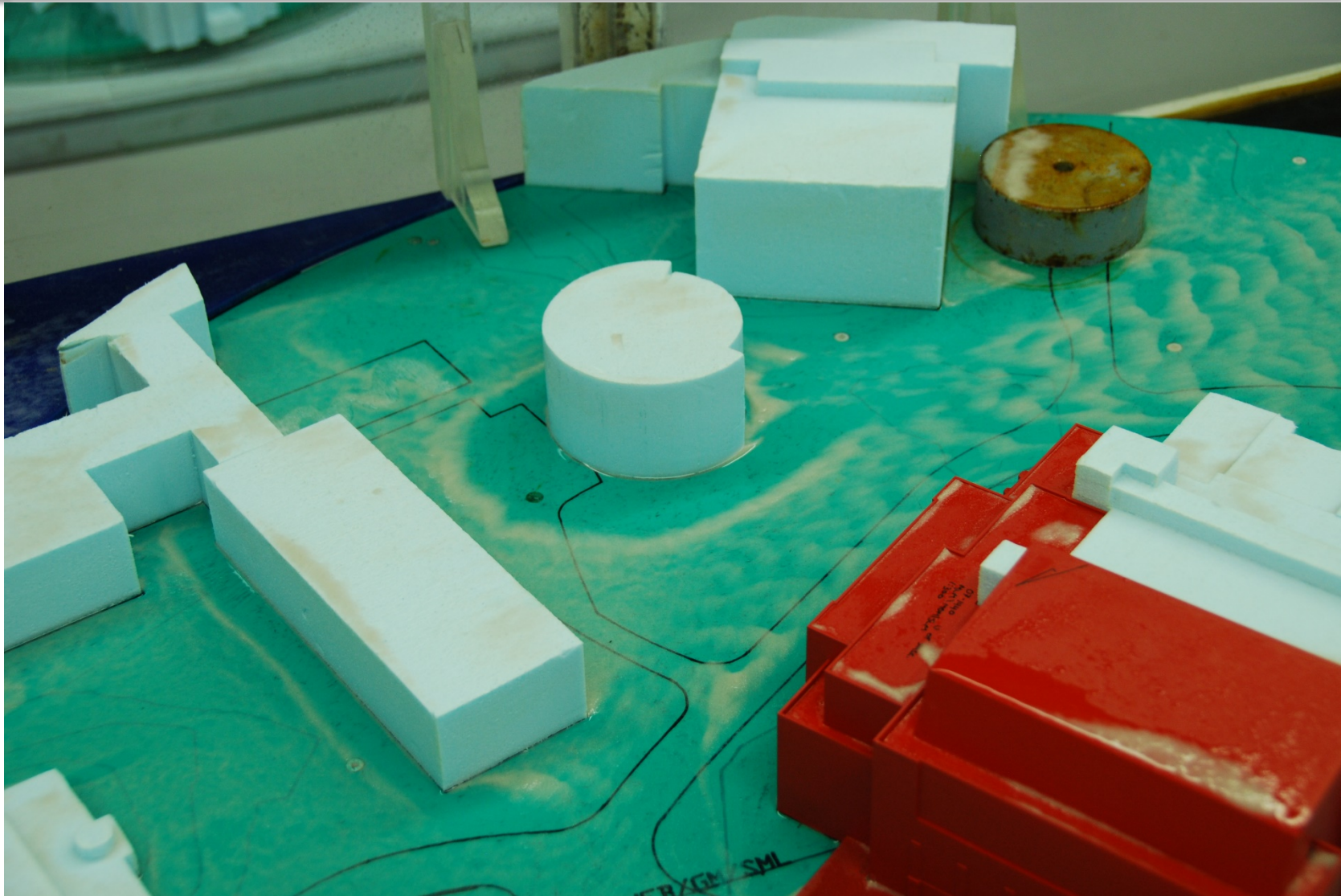

The study of building failures...

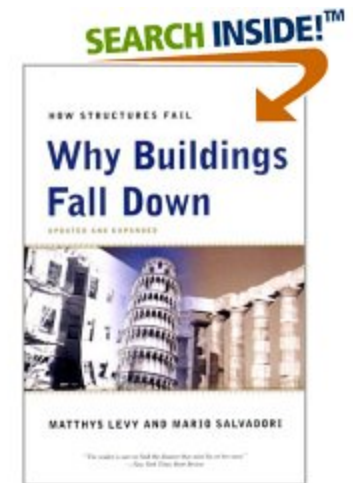
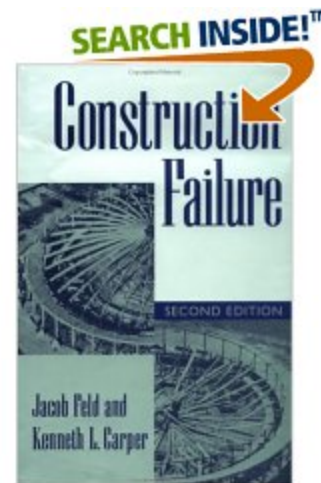
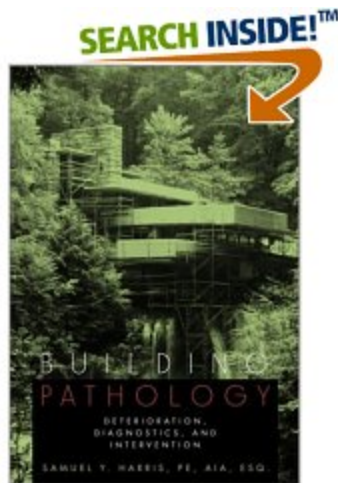
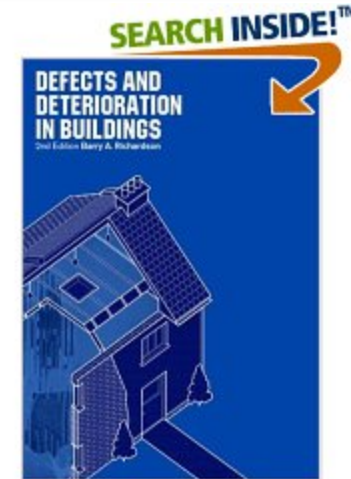
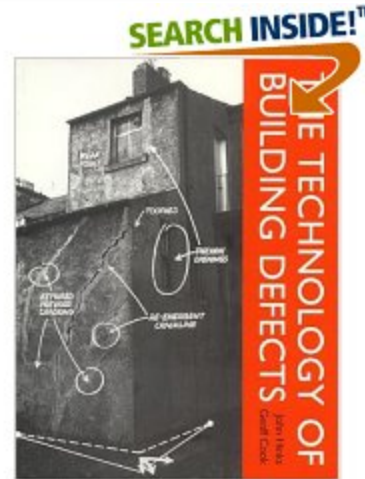
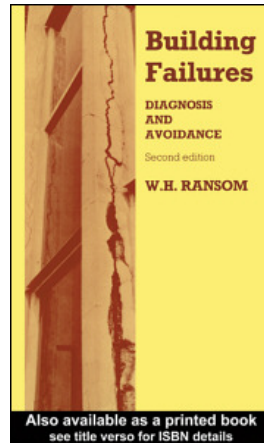

The question of so many new materials?

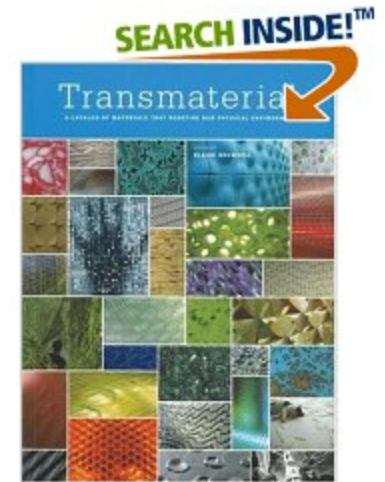

Adding to the complexity of the issue, there are a great many NEW materials that are now being used in buildings. Some of these have not been properly tested for all climates and weathering locations, and therefore might not work well. Research and investigation is necessary...