



Pedestrian Bridges

A Visual Overview of a Lot of Bridges

BRIDGES BY STRUCTURAL SUPPORT SYSTEM



Tied Arch



Suspension



Mast supported



Tubes/Trusses



Support below deck



Tension

Bridge concerns:

- Span – how far?
 - Over what?
 - Clear span or intermediate supports?
- Access to get on the bridge
- Edge support conditions
- Any height restrictions?
 - Support overhead
 - Support under deck
- Does any transportation need to go under the bridge?
- How do you transport it to location?

- Outside: materials, durability, corrosion

ARCH



Nagasaki, Japan



Glass Bridge
Perth, Australia









Orsay Footbridge
Paris, France











TIED ARCH



Pedestrian Bridge
Denver, Colorado









Humber Bay Bridge
Toronto, ON





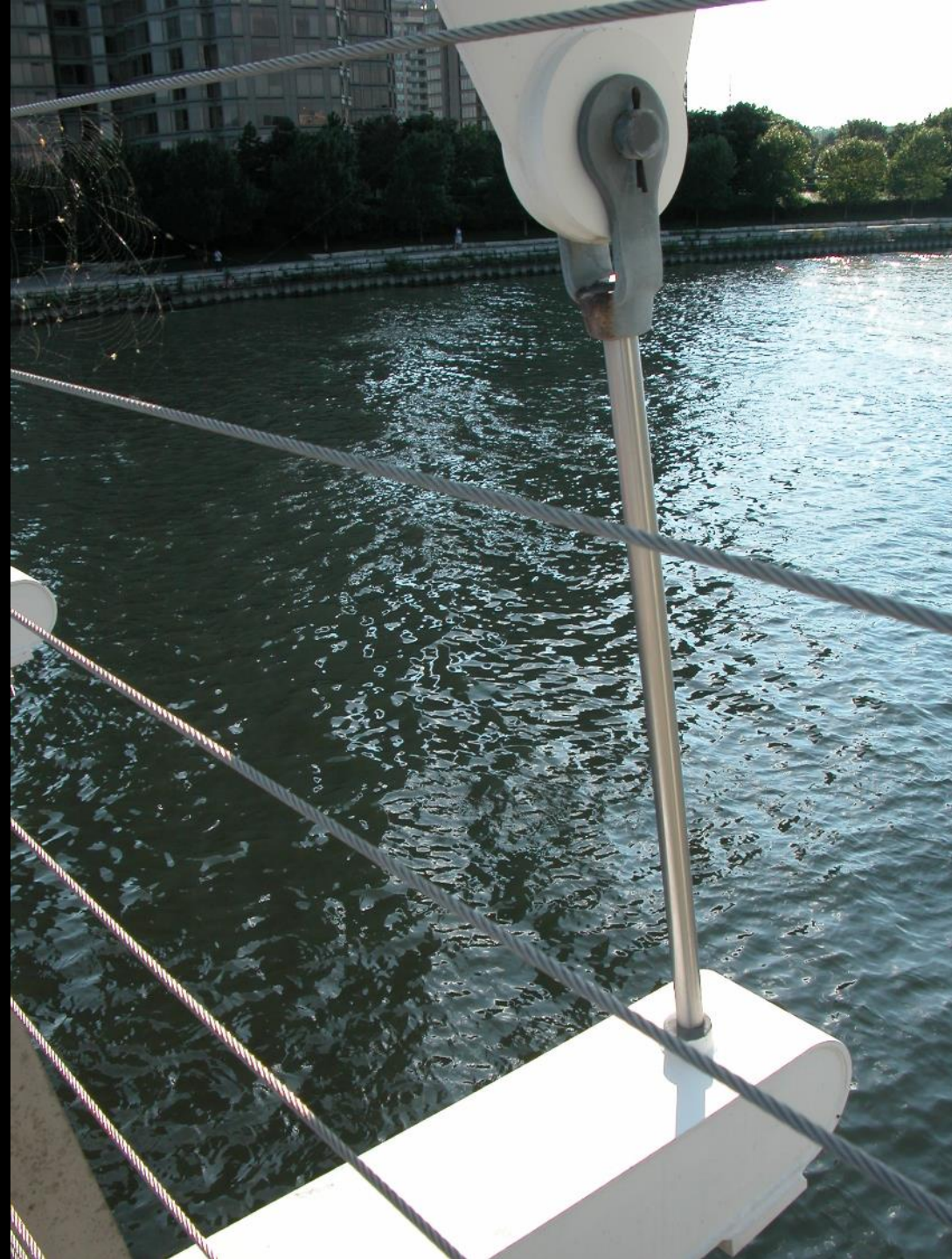







Pedestrian overpass
Richmond, BC















John Street Bridge
Toronto, ON







Commercial Station Bridge
Vancouver, BC

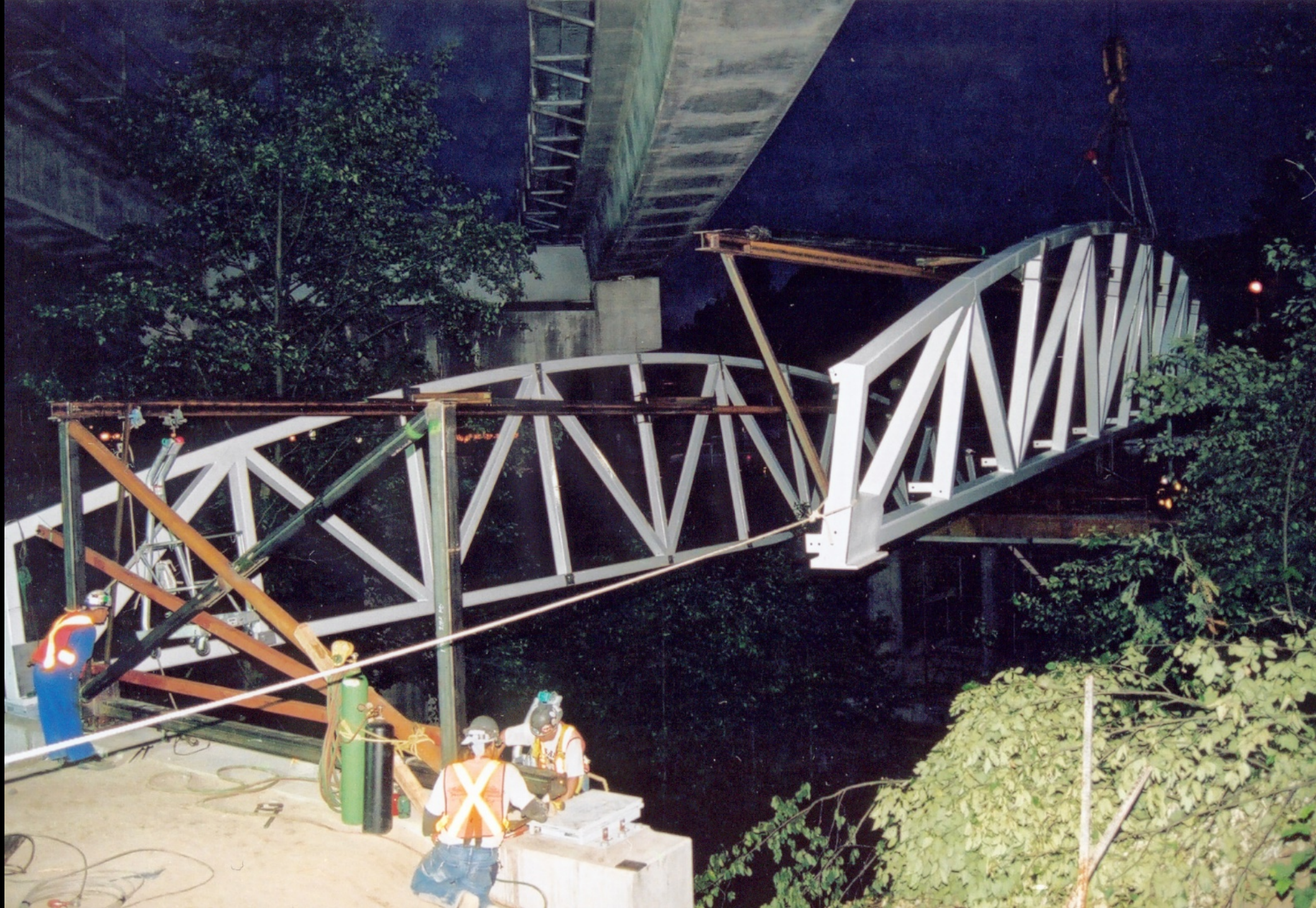







Trans Canada Highway overpass
Vancouver, BC











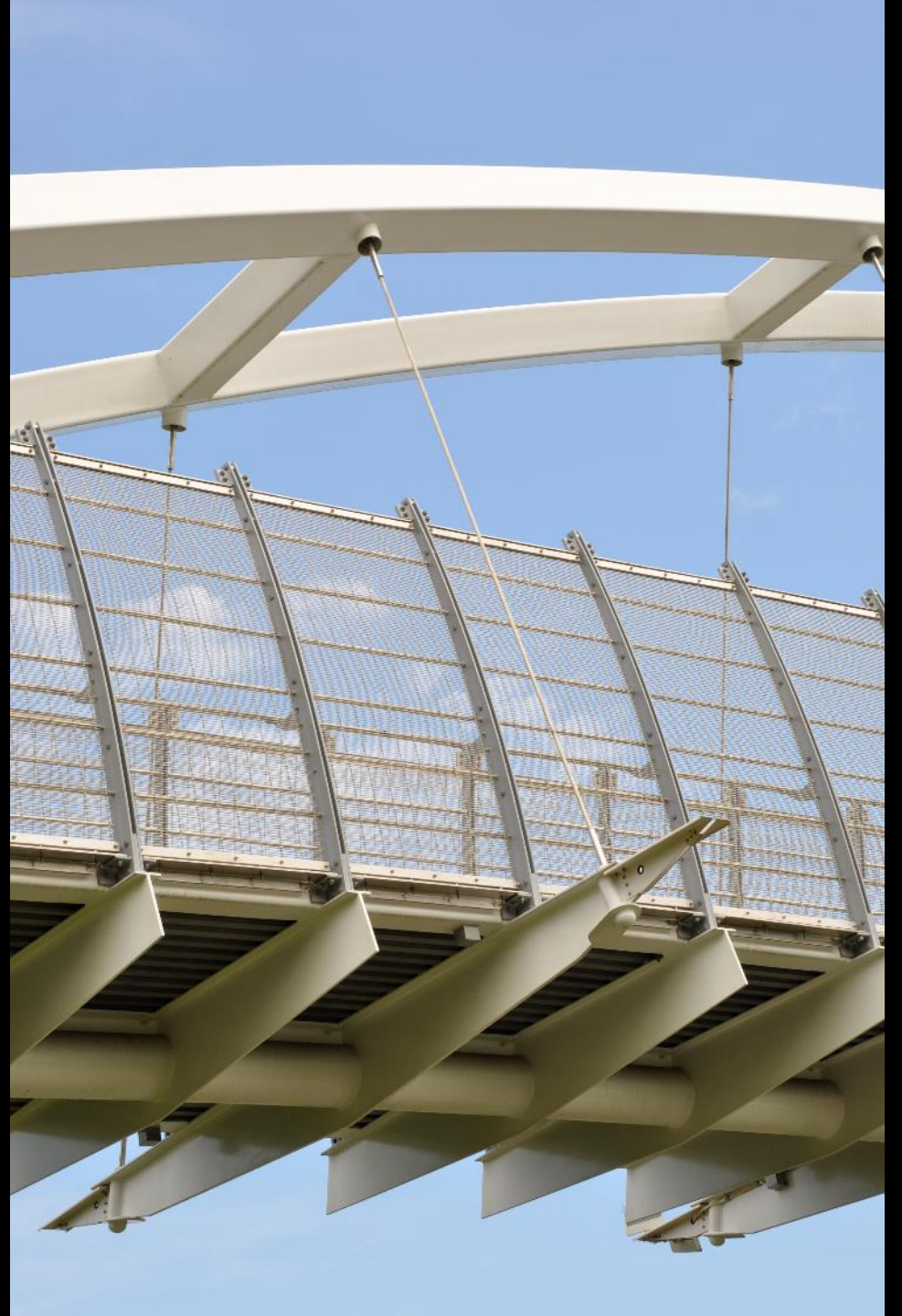



St. Patrick Bridge
Calgary, Alberta















Pedestrian Bridge
Olympia, Greece









Portlands Bridge
Toronto, ON



Cherry North - Alternative Axonometric

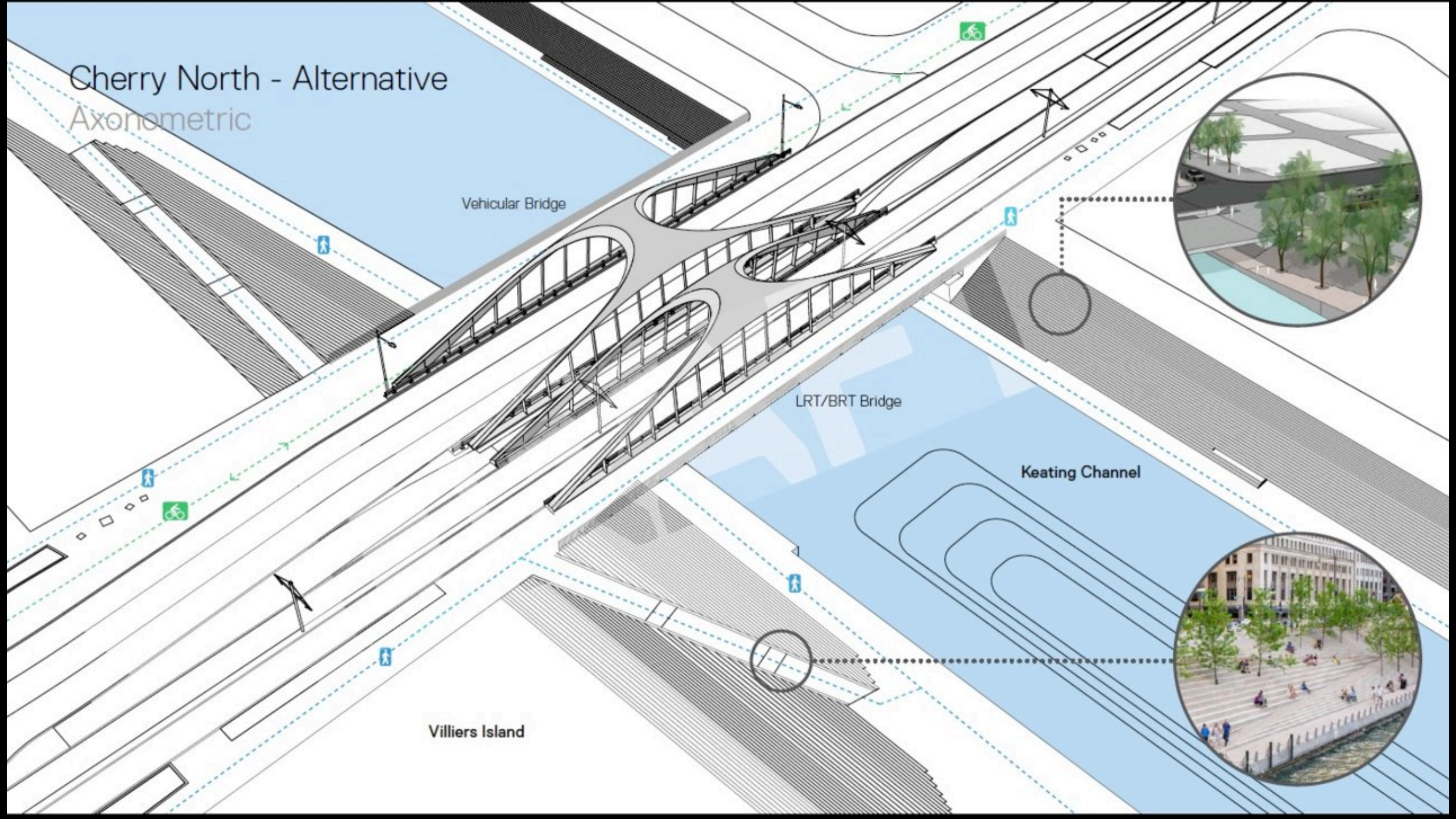

Vehicular Bridge

LRT/BRT Bridge

Keating Channel

Villiers Island













Amgen Bridge
Seattle, Washington



CANADIAN PACIFIC RAILWAY
Tide
11844
177

ACCESS TO PUBLIC FISHING







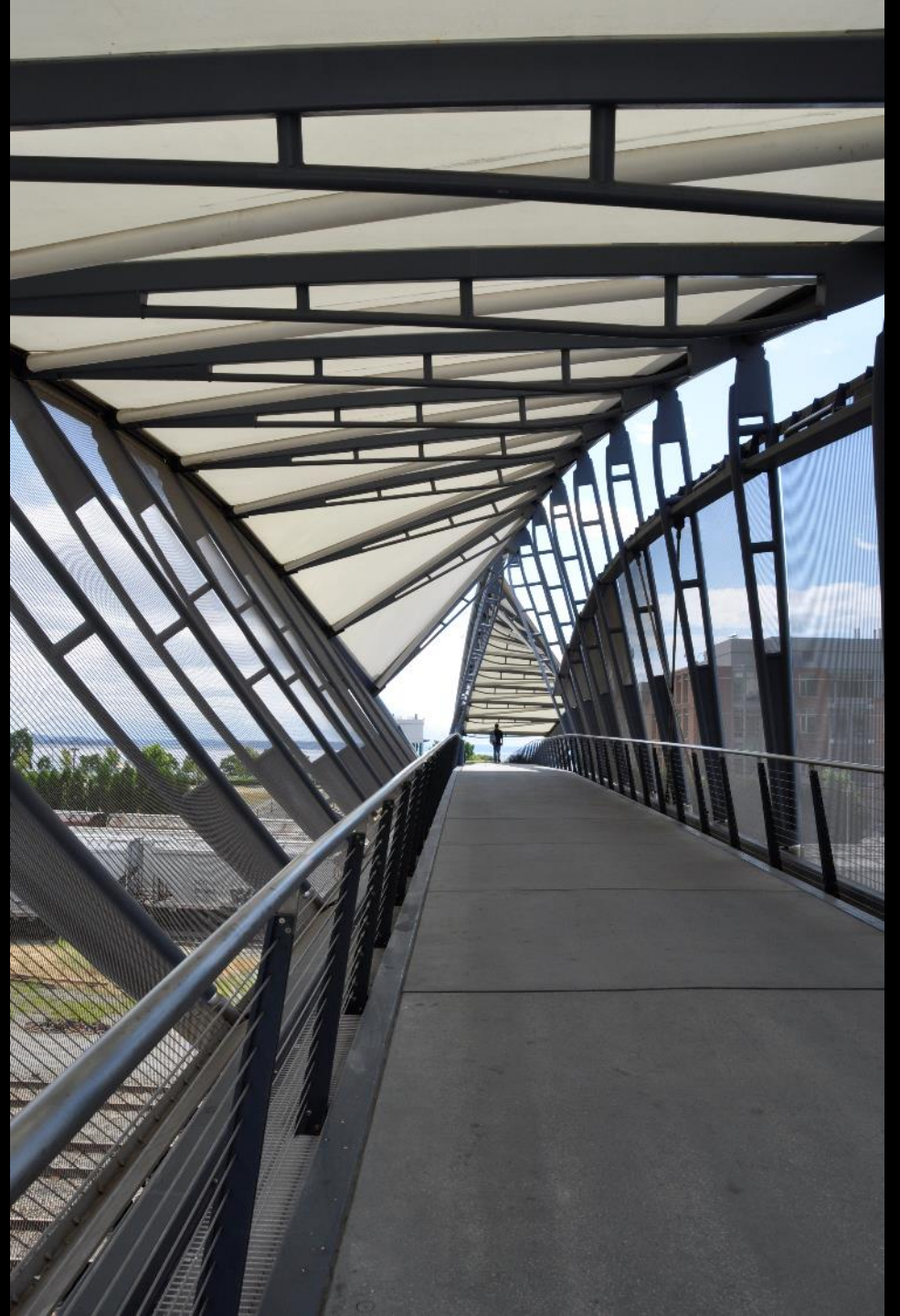





Pedestrian Bridge
Richmond, B.C.









Calatrava Bridge
Bilbao, Spain



RESTAURANT
CAFE















Lisbon Train Station Bridge
Calatrava













Mimico Creek Bridge – Calatrava
Toronto, ON











Red Hill Bridge
Hamilton, ON





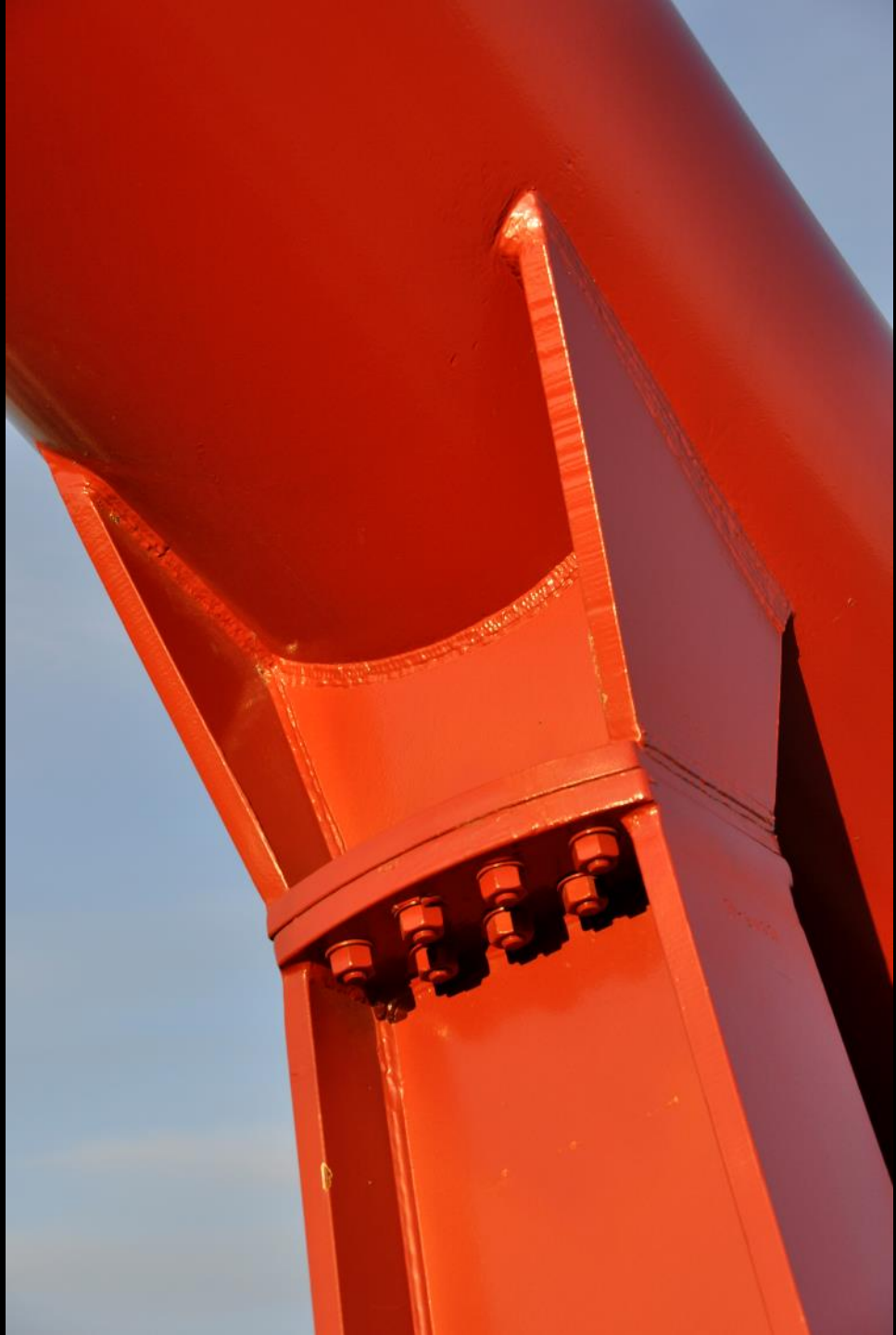

SUSPENSION



Miyazaki, Japan











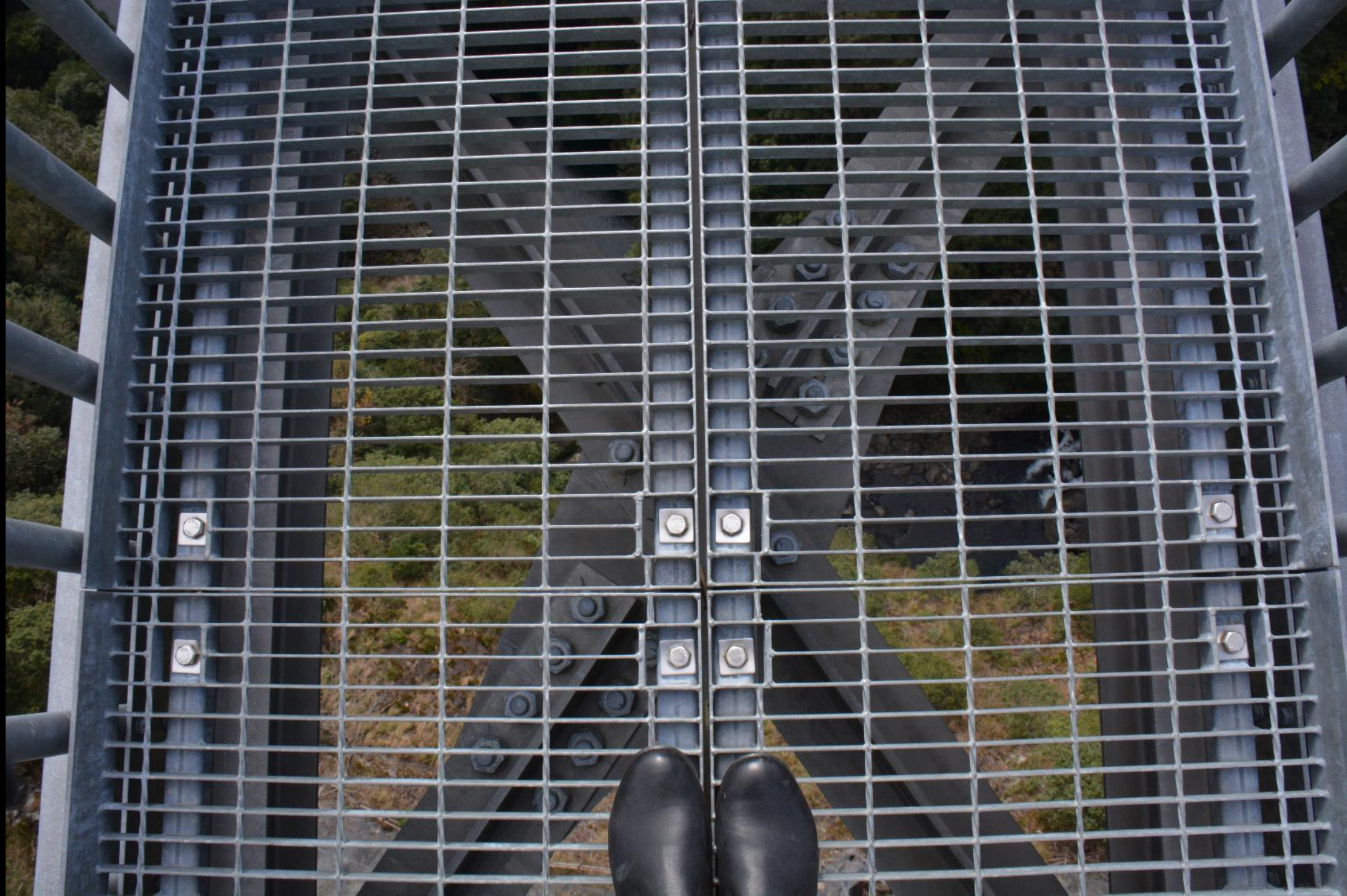



Yufuin, Japan







カメラの
フラッシュ
撮影しすぎ
は気軽に
かけください！
※撮影するお写真は希望無効です。



MASTS



Dalian, China













Jubilee Bridge
London, UK















Canary Wharf Bridge
London, UK











Northumbria University Bridge
Newcastle, UK











Paddington Basin Bridge
London, UK









The Point
Marks & Spencer

St. Mary's Road



La Villette Raised Walkway
Paris, France





cité

LIWEI
李晔



Pedestrian Bridge
Denver, Colorado







Louis Riel Bridge
Winnipeg, Manitoba









Bridge, Calatrava
Valencia, Spain



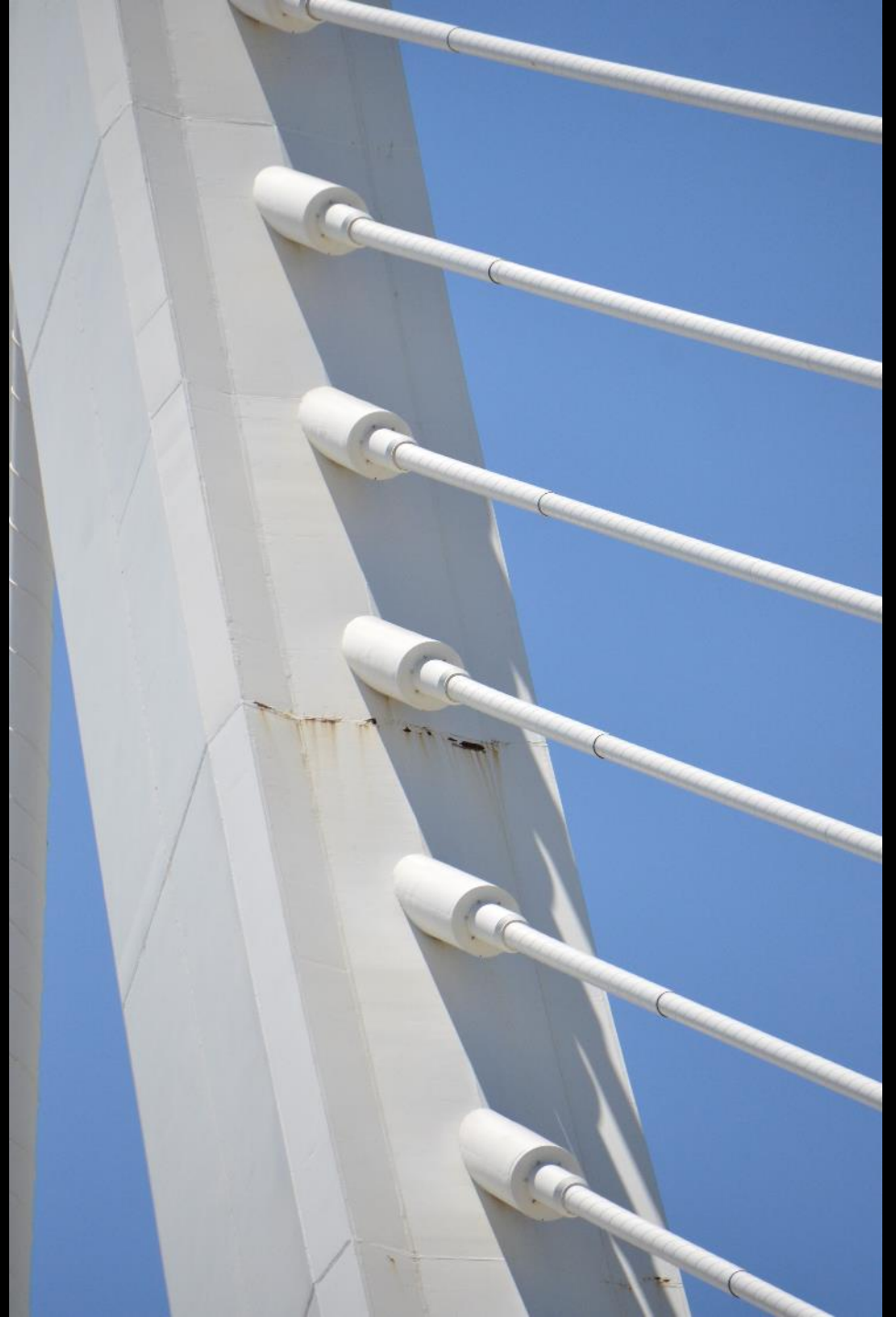
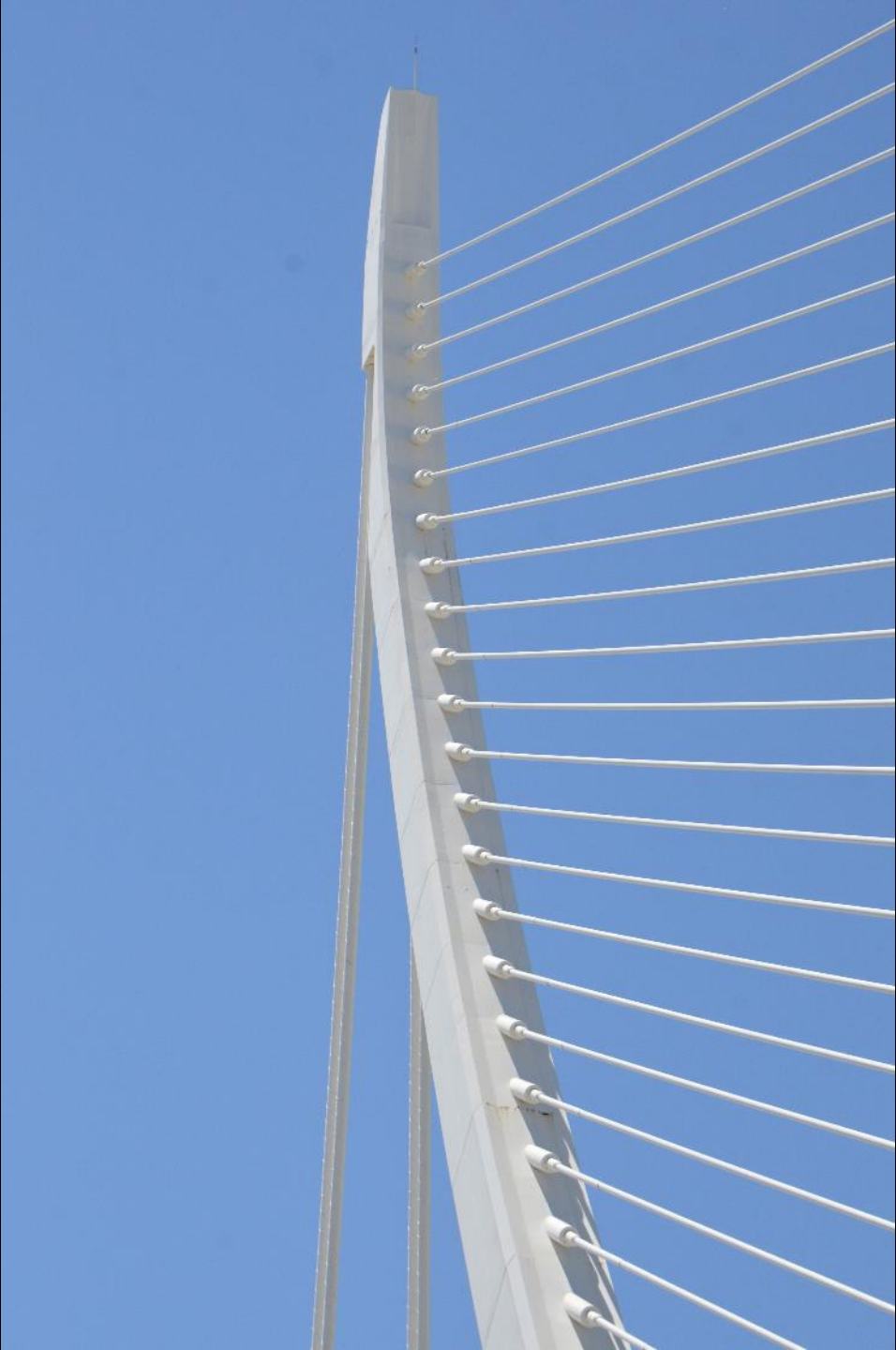





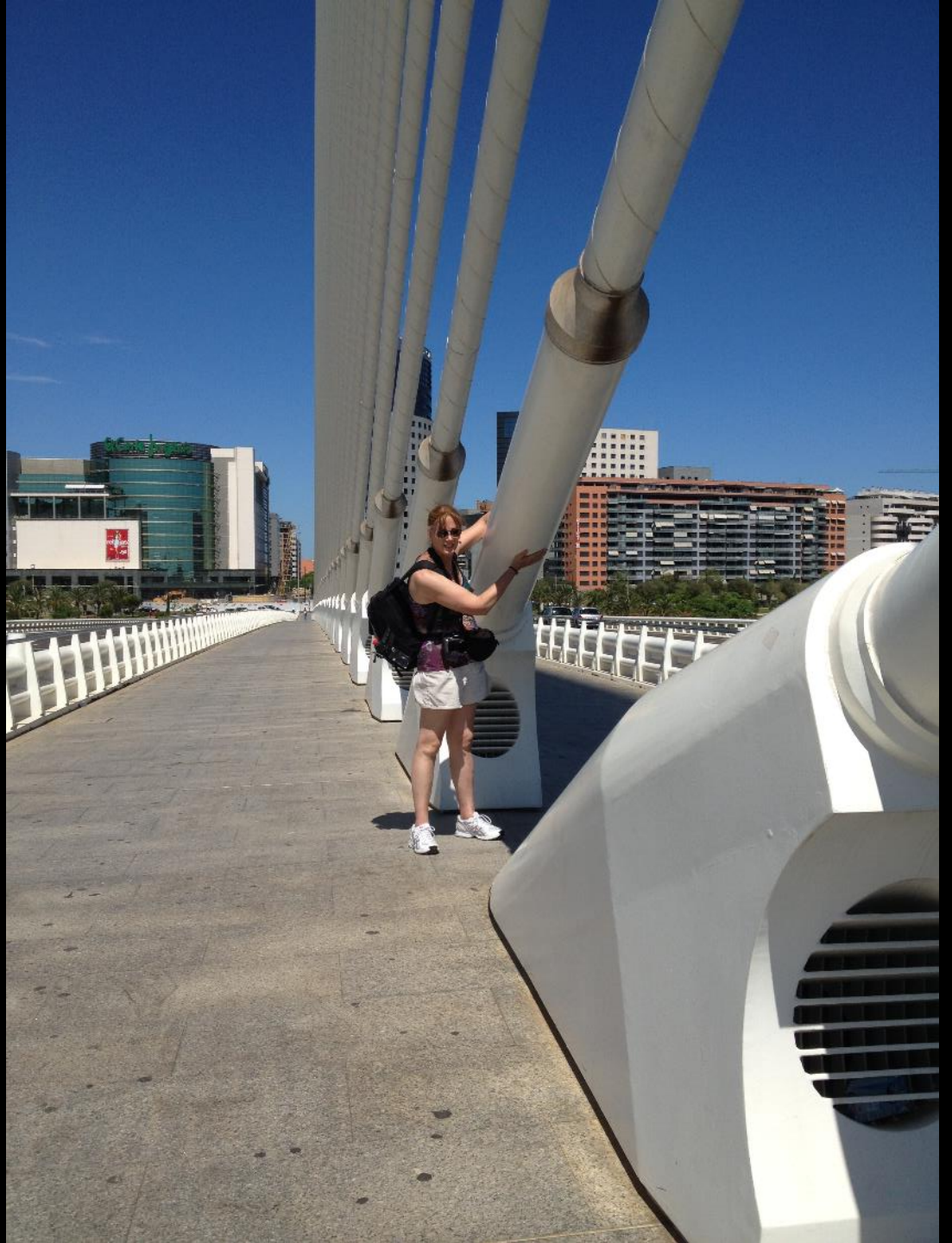



Poplar Street Station
London, UK

A1261. The City (A13)
Canary Wharf
W.I. Quay
(A1206) 

Tower Bridge, Wapping (A1203)











POPV







A wide-angle photograph of the Docklands Bridge in Melbourne, Australia. The bridge is a white, cable-stayed pedestrian bridge with a distinctive design of three large, interconnected loops. It spans across the Yarra River. In the background, a modern city skyline is visible, featuring several high-rise buildings, including a prominent one with a curved facade and blue-tinted windows. The sky is overcast and grey. In the foreground, a wooden pier with a metal railing and a lamp post extends from the right side towards the bridge. A few people can be seen walking on the pier. The water of the river is dark and slightly rippled.

Docklands Bridge
Melbourne, Australia

















Kurilpa Bridge
Brisbane, Australia





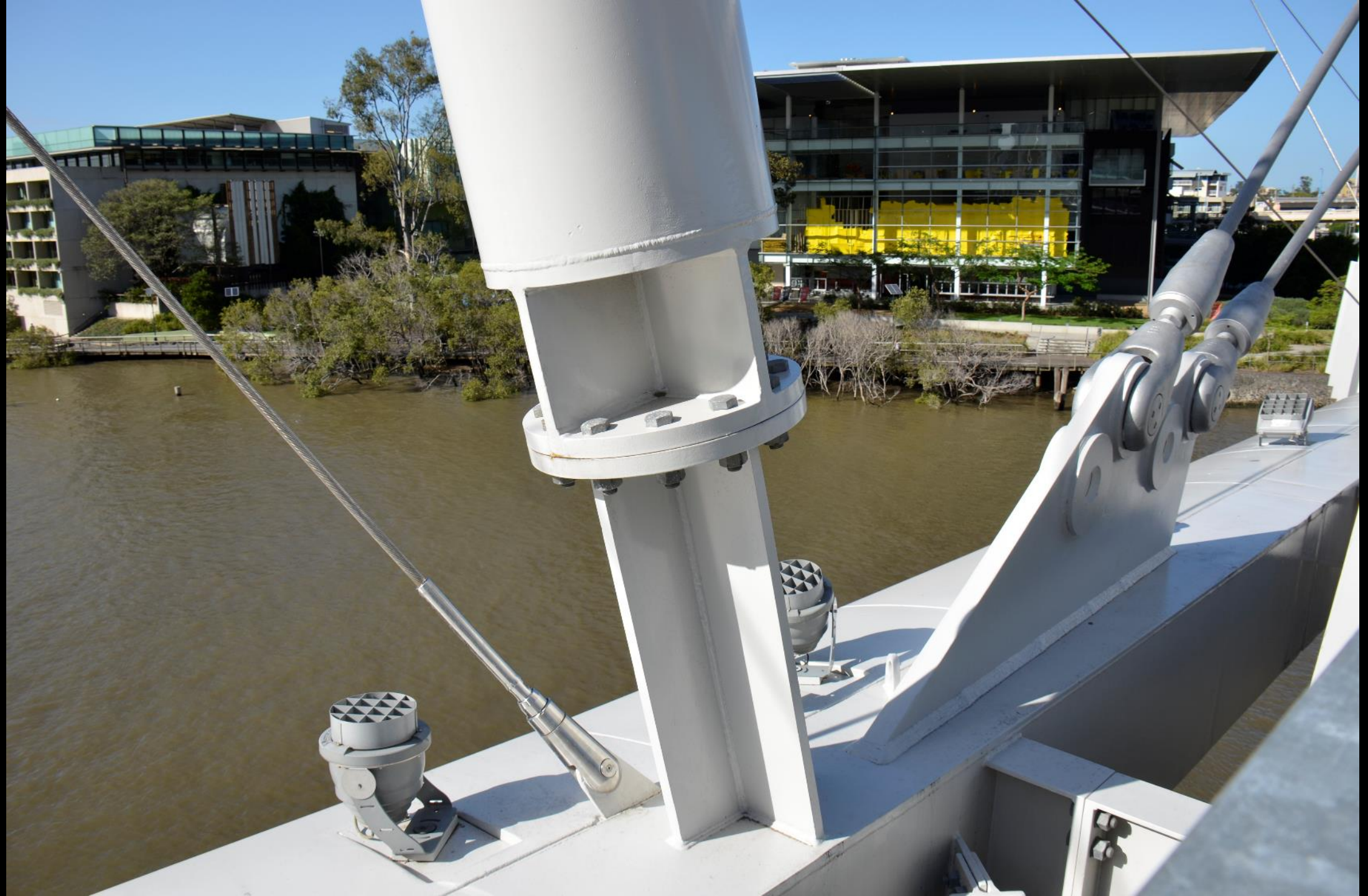





CLEARANCE 5.6 m

CLEARANCE 5.3 m



TUBES/TRUSSES



Covered Bridge
Golden, B.C.



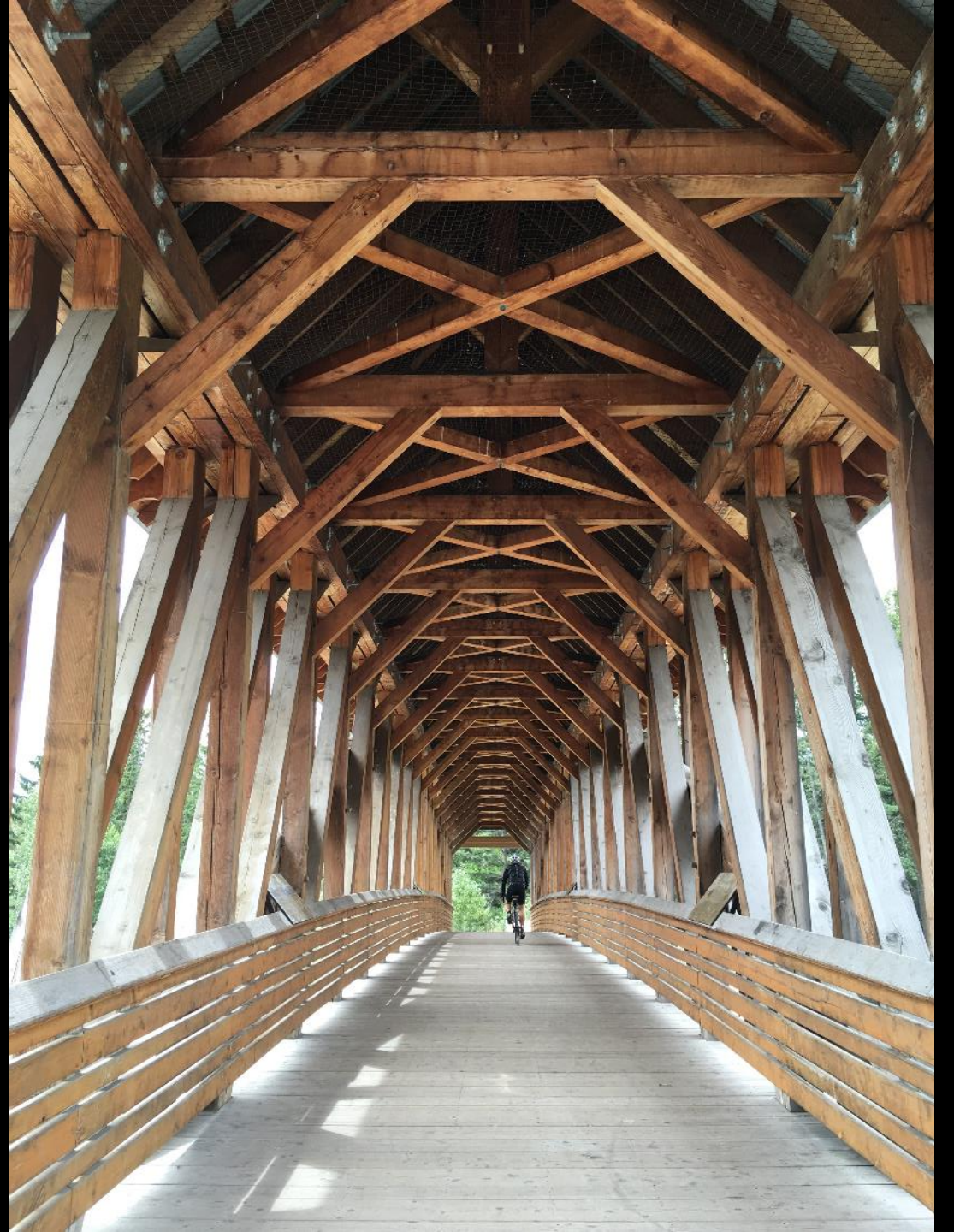







Paddington Basin Bridge
London, U.K.







Puenta de Luz
Toronto, ON







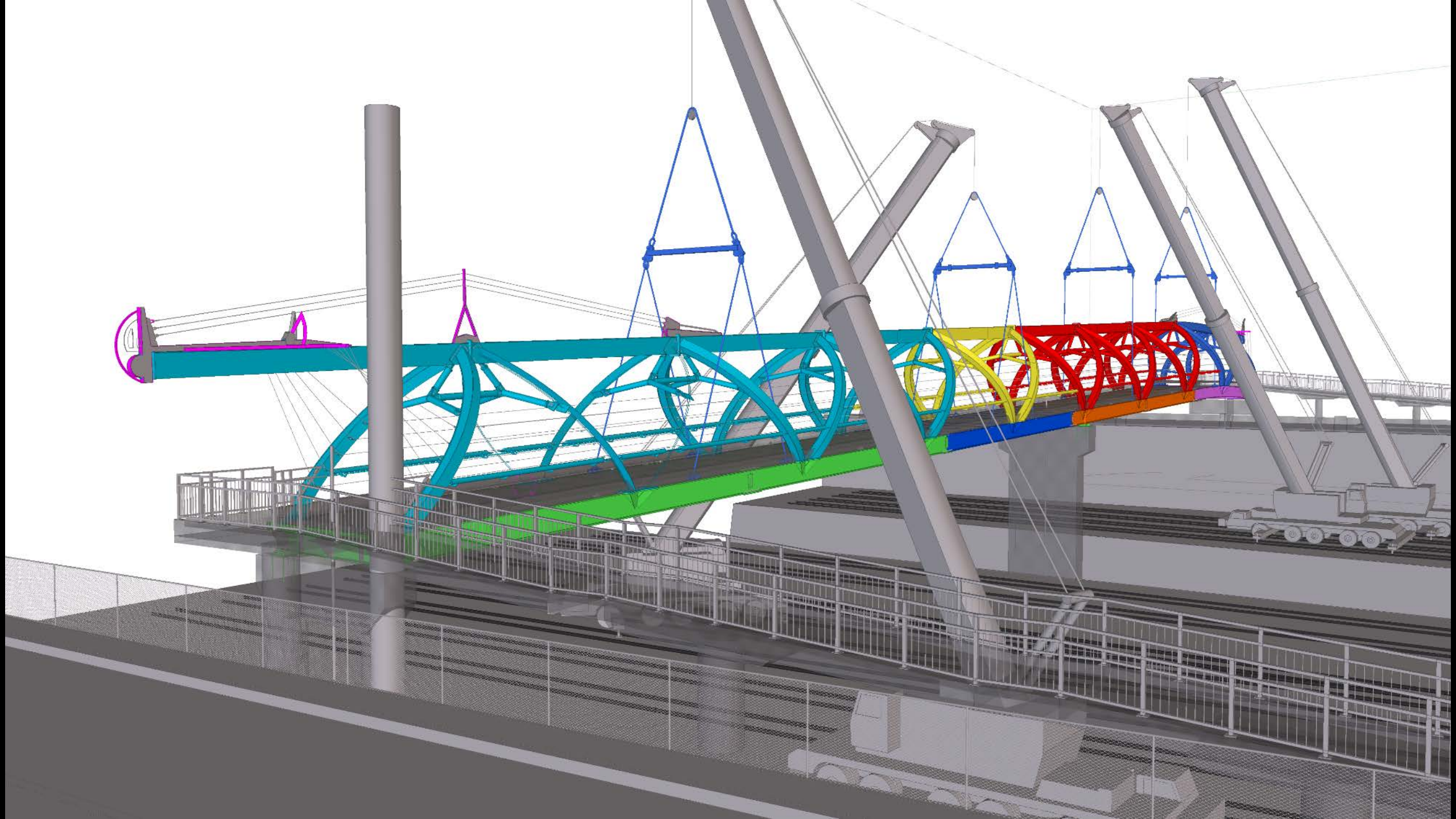

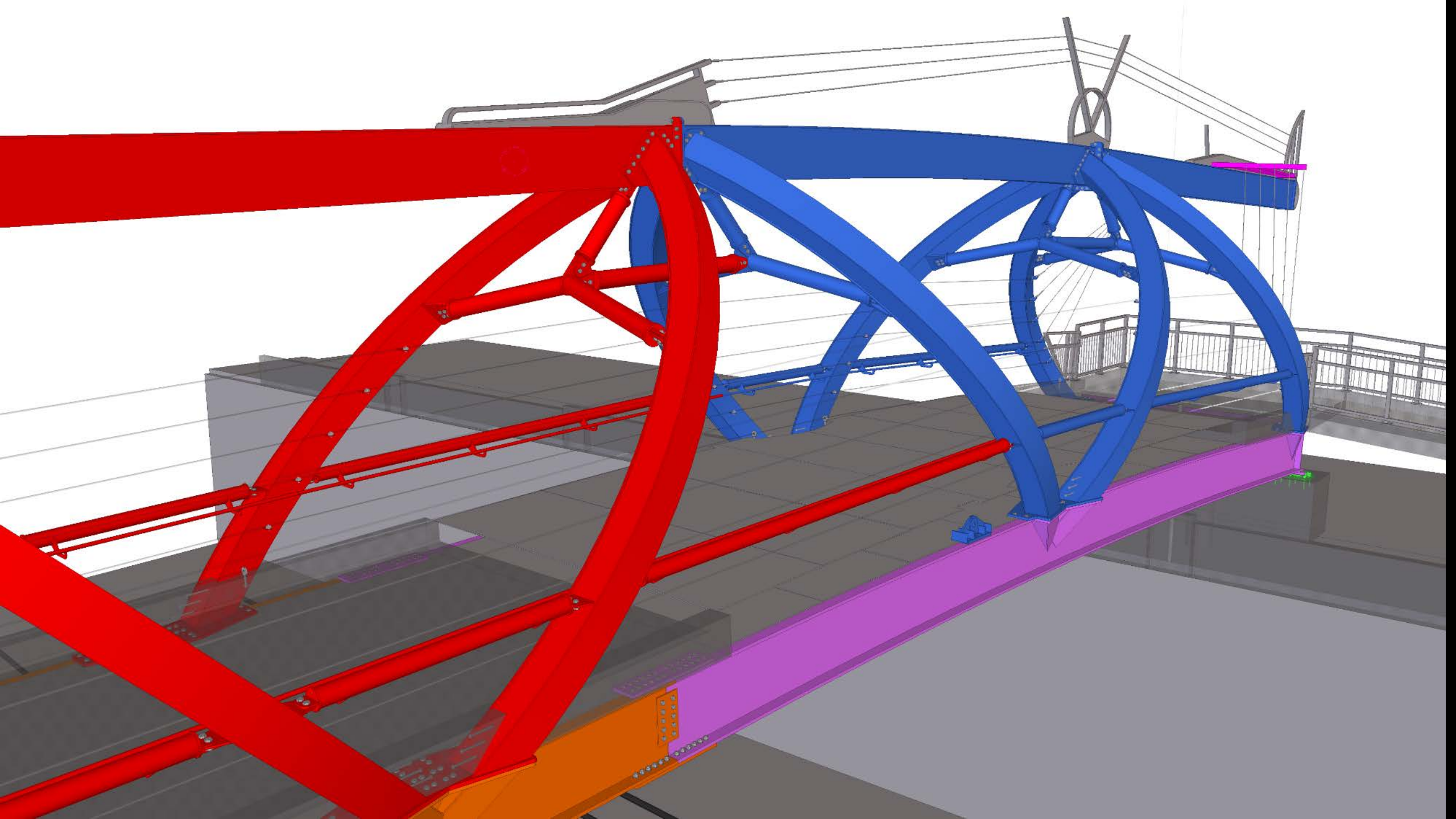



Seattle Flight Museum Bridge
Seattle, Washington





BOEING AIRPLANE CO

OFFICE









Peace Bridge – Calatrava
Calgary, Alberta













Arganzuela Bridge
Madrid, Spain

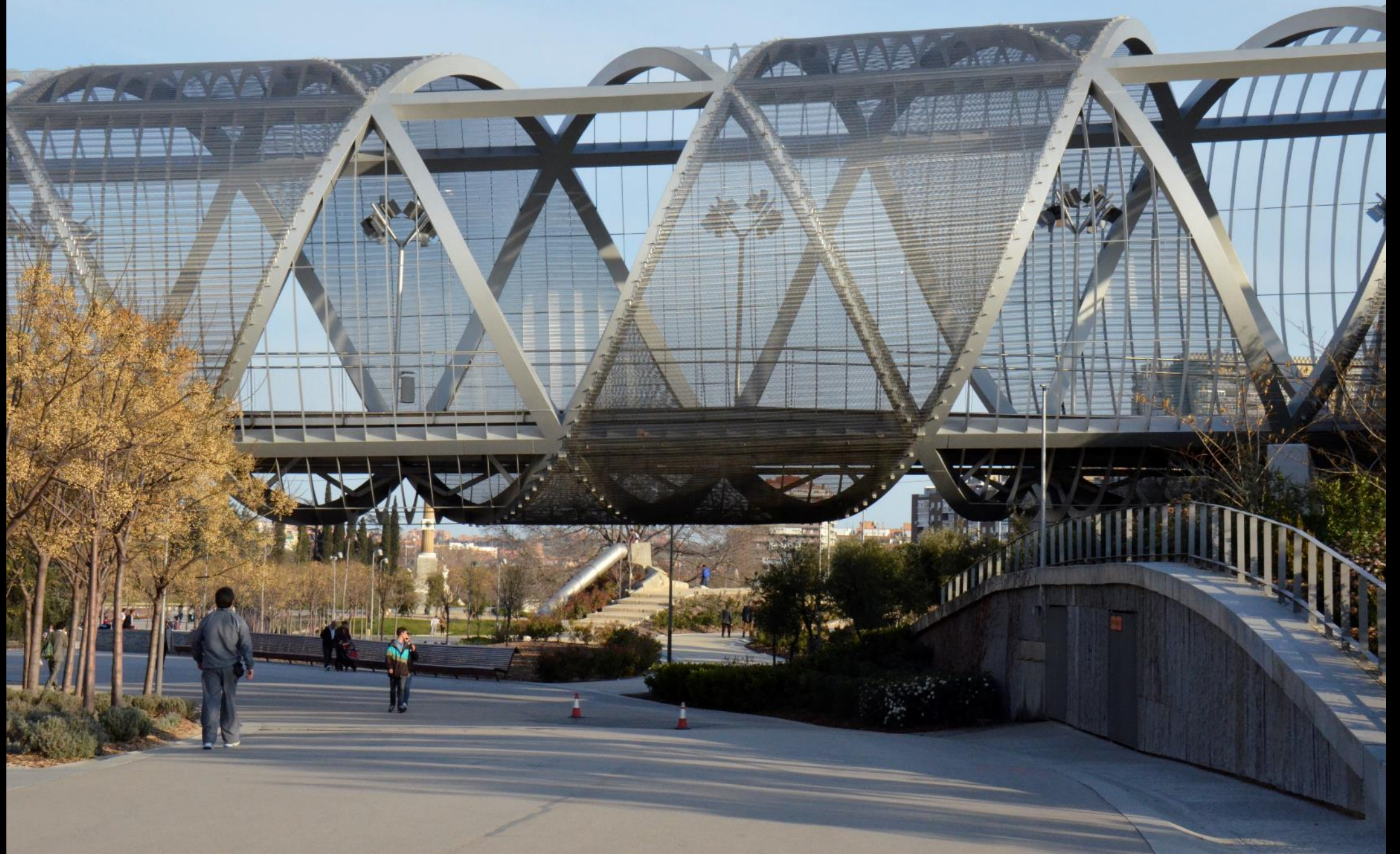



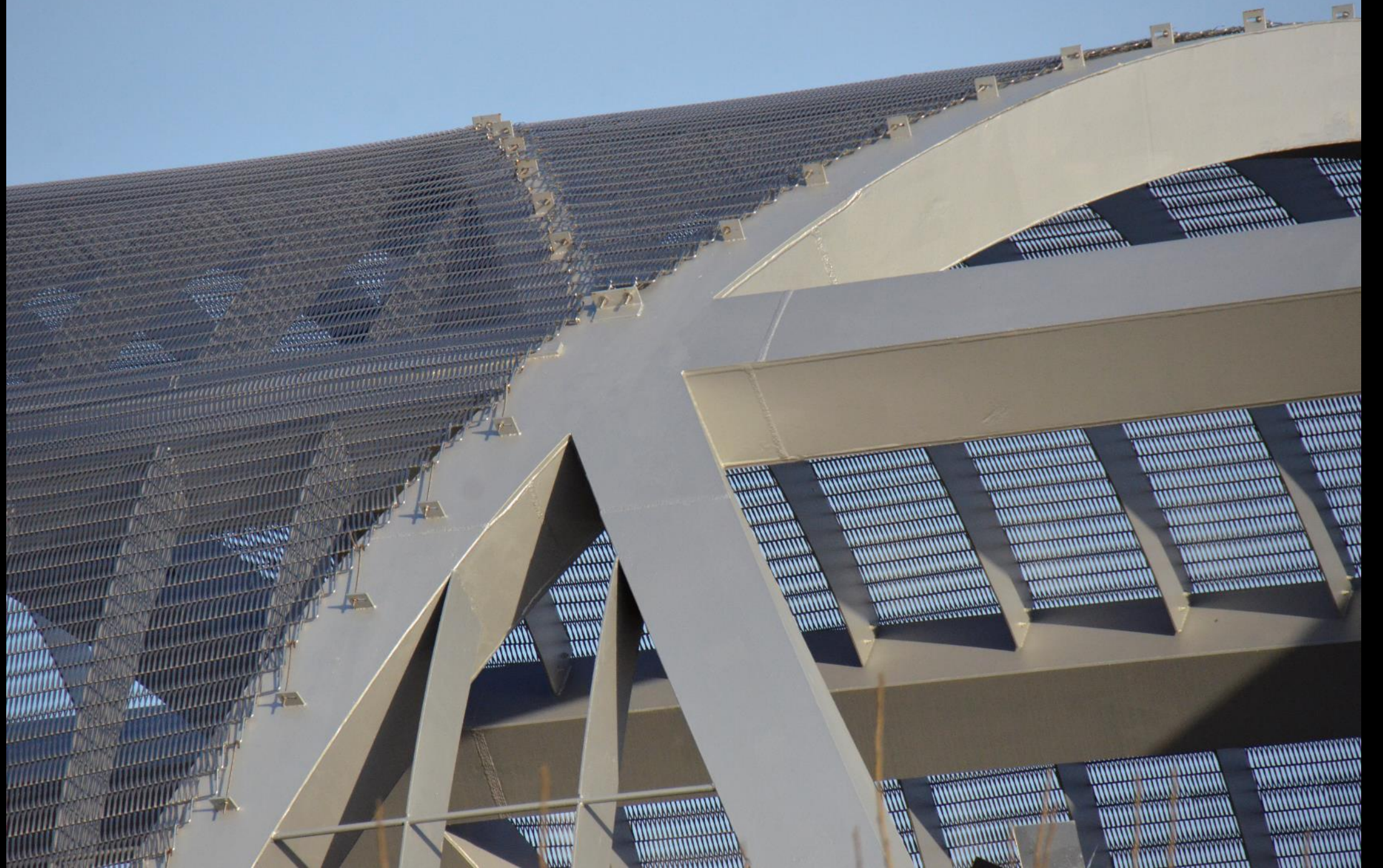







Web Bridge
Melbourne, Australia

Car Museum
Abb Bridge
Lands Park
Batman TAFE













La Roche sur Yon Bridge
France

Next set of photos not Terri's





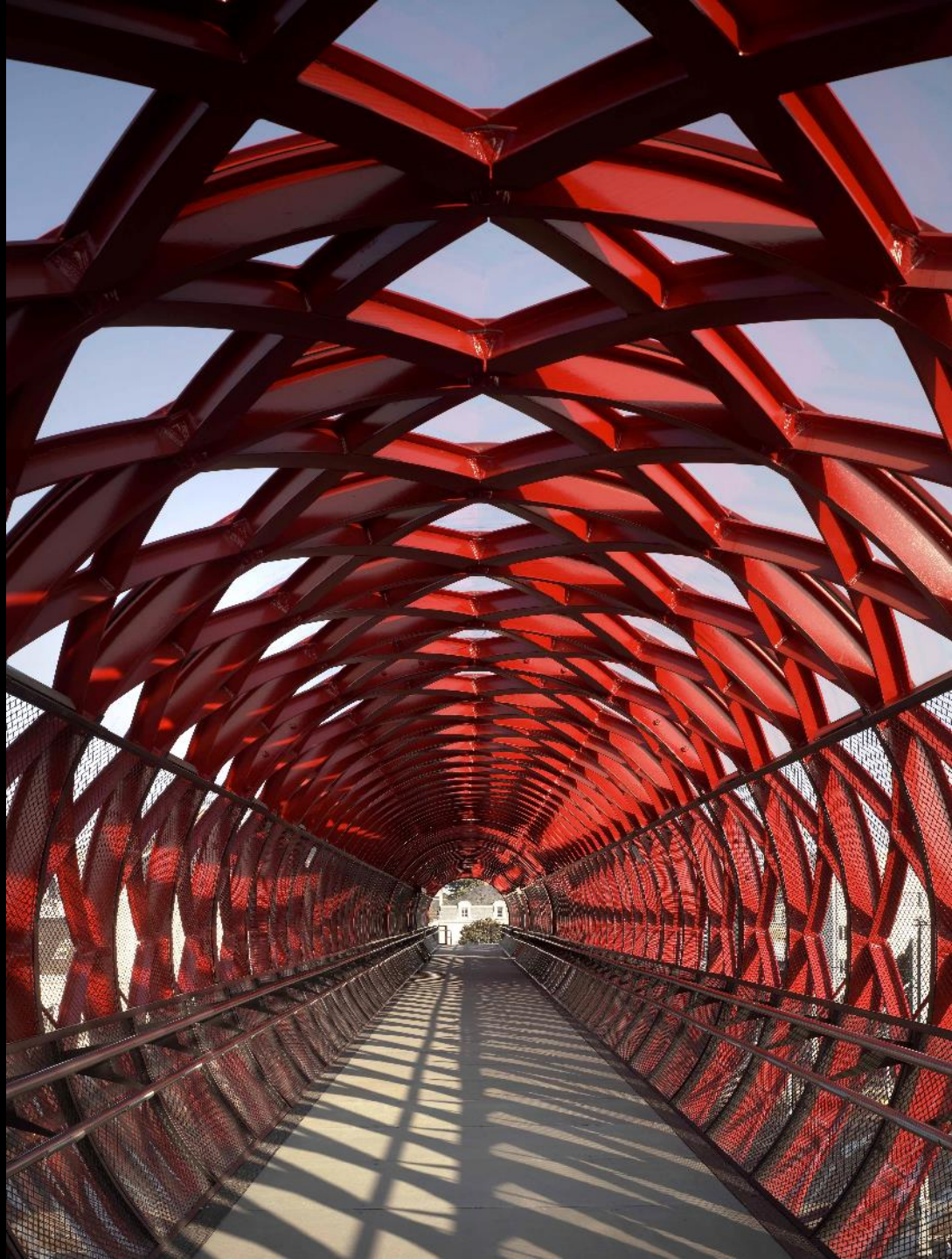

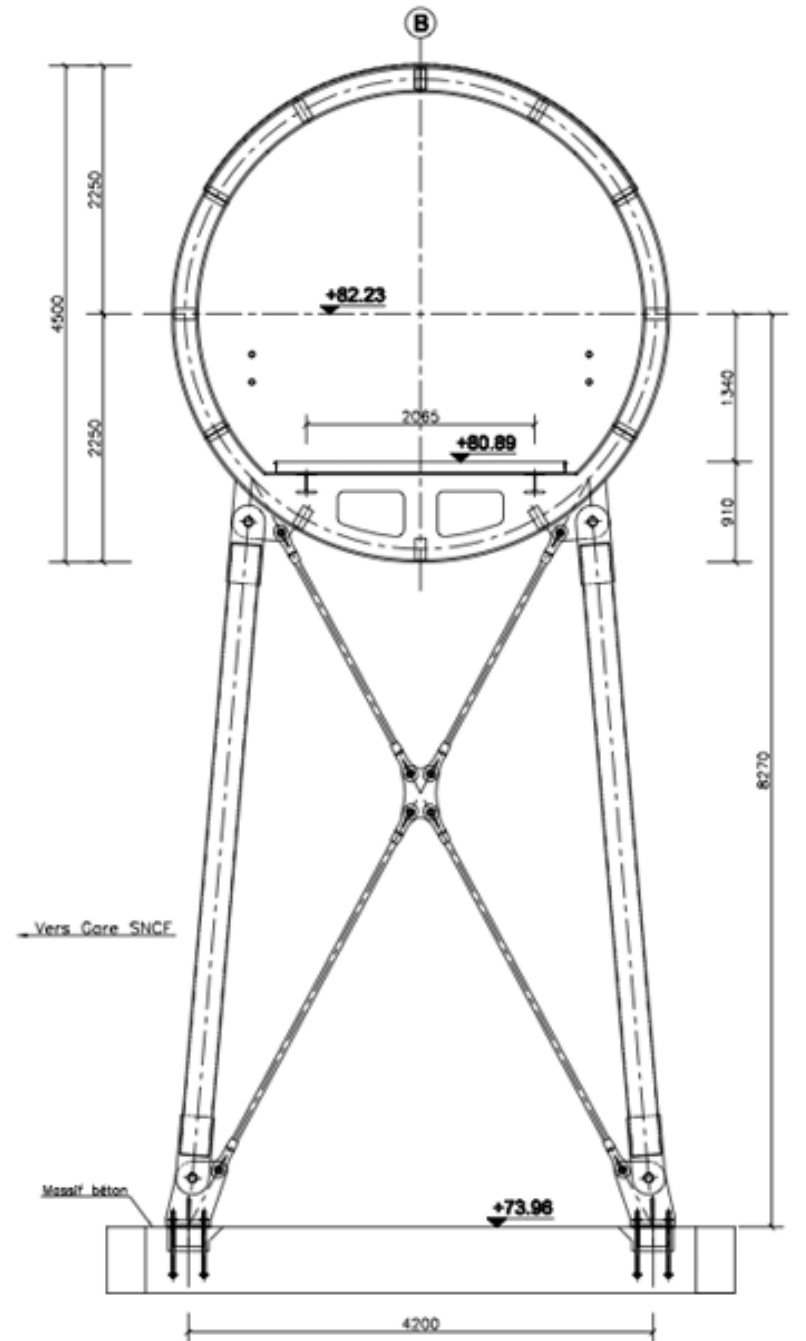



Helix Bridge
Singapore













Tokyo International Forum
Tokyo, Japan









Skytrain Station Bridge
Vancouver, B.C.



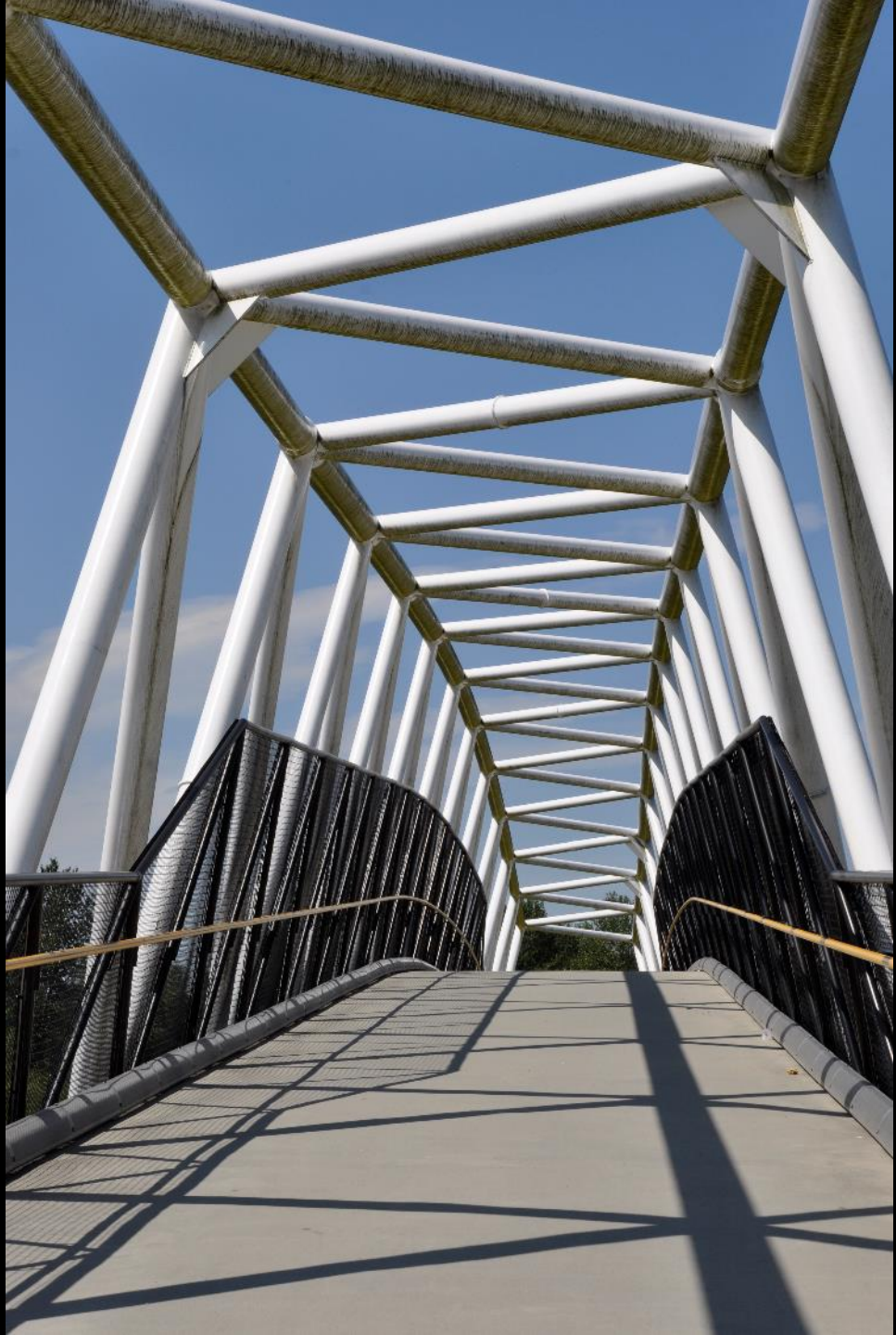





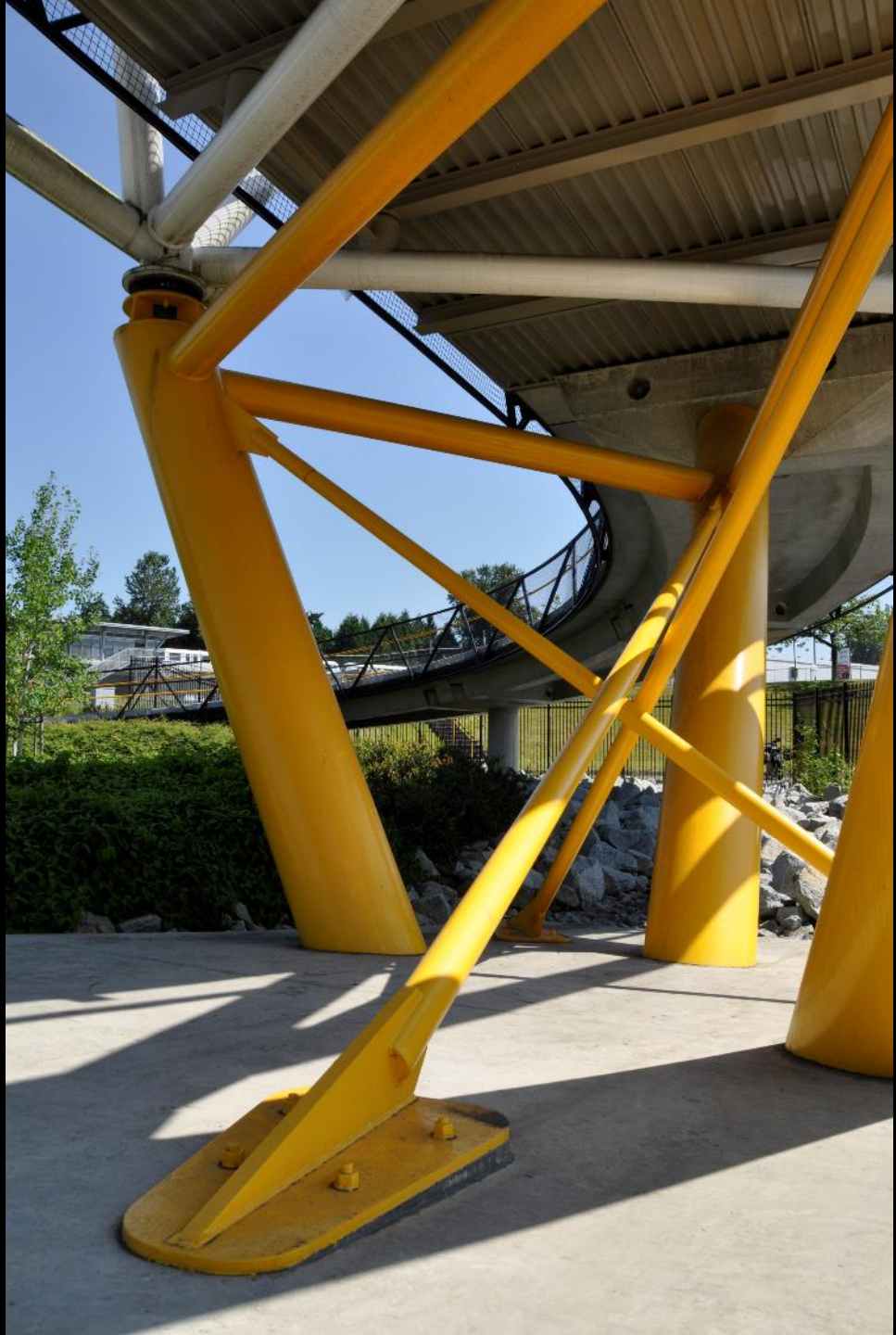



Prefectural Art Museum – Shigeru Ban
Oita, Japan







RUMIX





A photograph of the Art Gallery Bridge in Wellington, New Zealand. The bridge is a prominent yellow structure with a glass railing, connecting two modern buildings. The building on the left has a grey facade, while the one on the right is tan. The bridge is supported by a complex system of yellow beams. In the foreground, there is a paved area and a planter bed with various green plants and trees. The sky is overcast.

Art Gallery Bridge
Wellington, New Zealand







London Olympic Site Access Bridge
London, U.K.









Pedestrian Over Highway Bridge
Melbourne, Australia













Drift Bridge
Ft. Worth, Texas

Next set of photos not Terri's





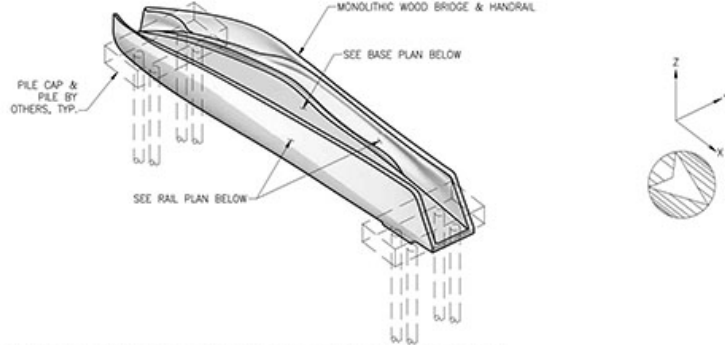

NOTES:
1. SEE ARCHITECTURAL DRAWINGS AND MODEL FOR ALL GEOMETRY, LOCATION, AND EXTENTS INFORMATION.

ISO VIEW OF MONOLITHIC WOOD BRIDGE

1/8" = 1'-0"

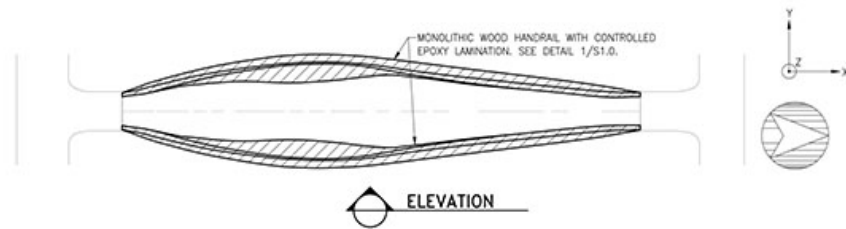

ELEVATION

MONOLITHIC WOOD BRIDGE UPPER HANDRAIL PLAN

1/8" = 1'-0"

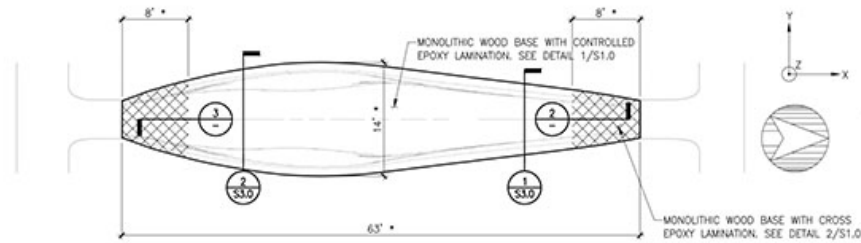

MONOLITHIC WOOD BRIDGE LOWER BASE PLAN

1/8" = 1'-0"

NOTES:
1. * ON PLAN INDICATES APPROXIMATE BRIDGE LENGTH FOR REFERENCE ONLY. SEE ARCHITECTURAL DRAWINGS FOR FINAL DIMENSIONS.

ARCHITECT TO REVIEW CODE-REQUIREMENT OF GUARDRAIL AT BENCH LOCATIONS

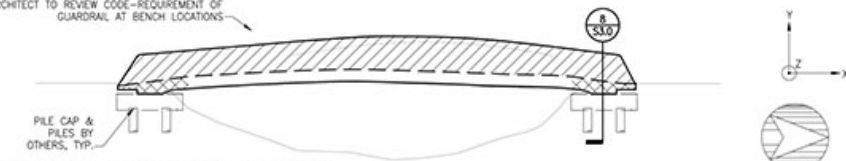

MONOLITHIC WOOD BRIDGE ELEVATION

1/8" = 1'-0"

TABLE OF REACTIONS							
REACTION PER PILE CAP	LOAD TYPE	X DIRECTION [K]	Y DIRECTION [K]	Z DIRECTION [K]	M _X DIRECTION [K-FT]	M _Y DIRECTION [K-FT]	M _Z DIRECTION [K-FT]
	DEAD LOAD	0	0	15	0	0	0
	LIVE LOAD	0	0	25	±15	0	0
	WIND LOAD	±1	±5	0	±10	0	±15 (NORTH) ±0 (SOUTH)

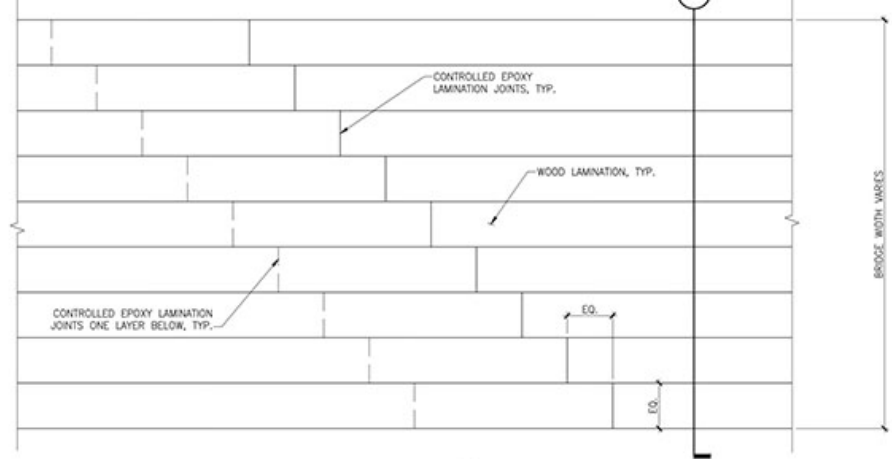

PLAN VIEW



3/4" = 1'-0"

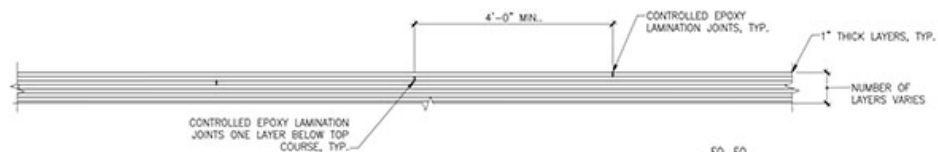

ELEVATION VIEW A-A

3/4" = 1'-0"

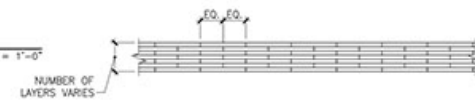

SECTION VIEW B-B

3/4" = 1'-0"

1 TYPICAL LAMINATION LAYUP

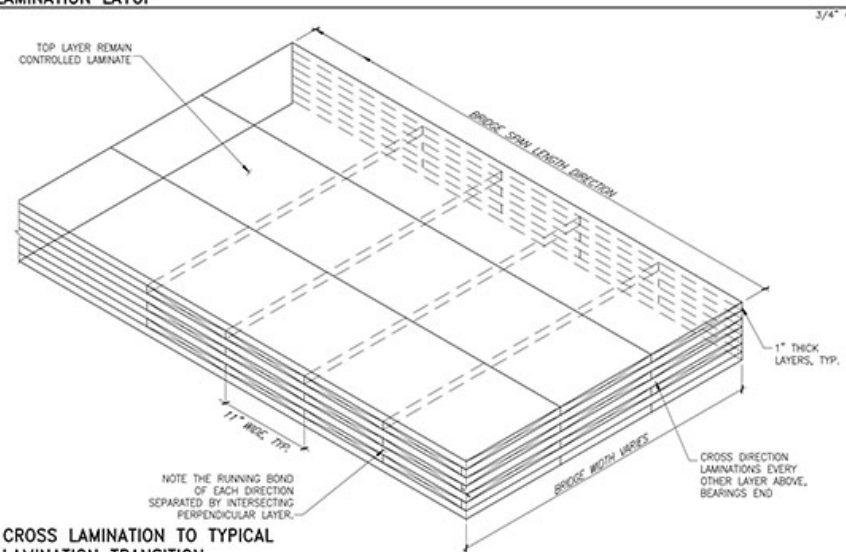

2 CROSS LAMINATION TO TYPICAL LAMINATION TRANSITION

1 1/2" = 1'-0"

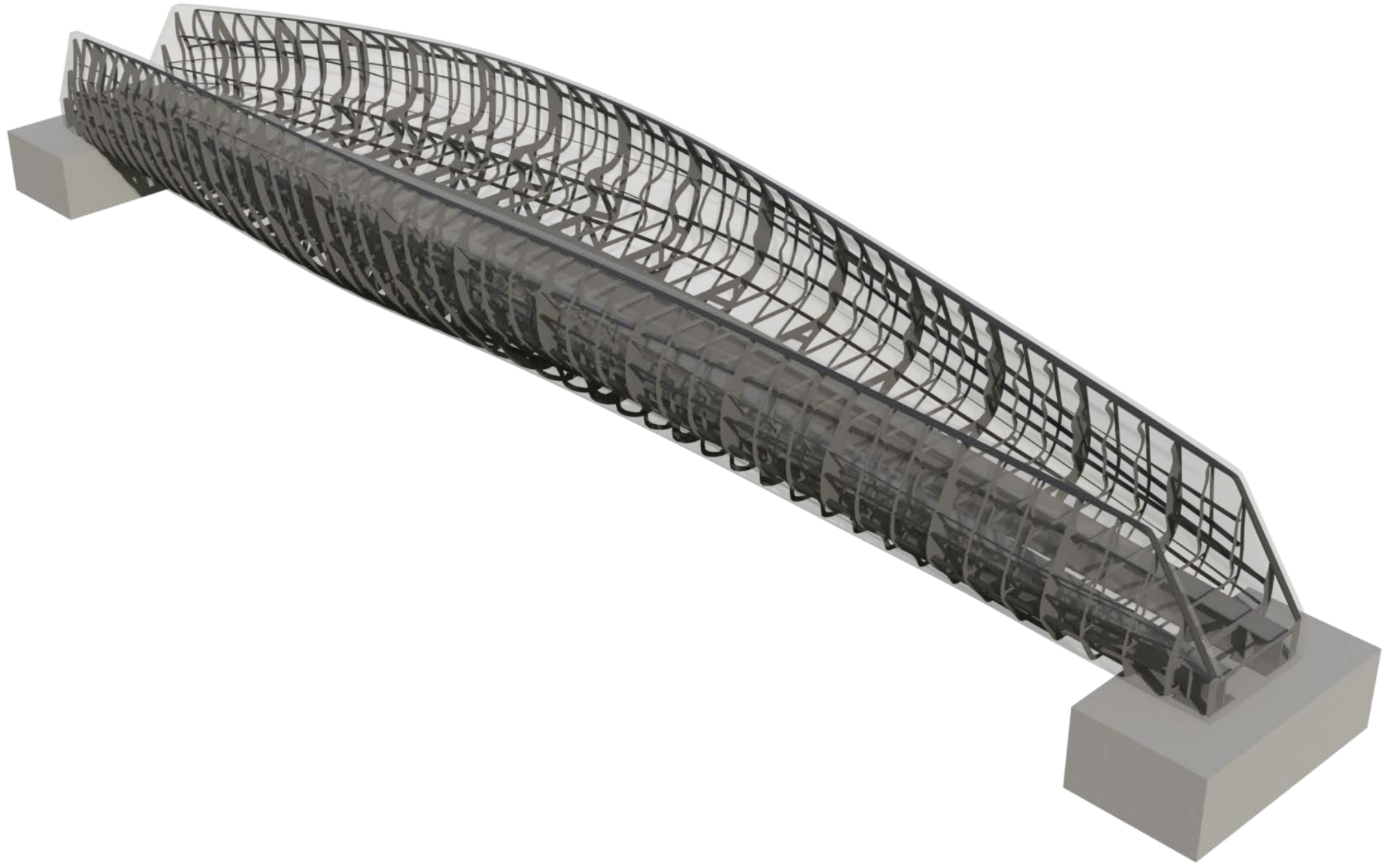

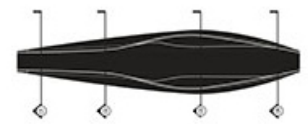
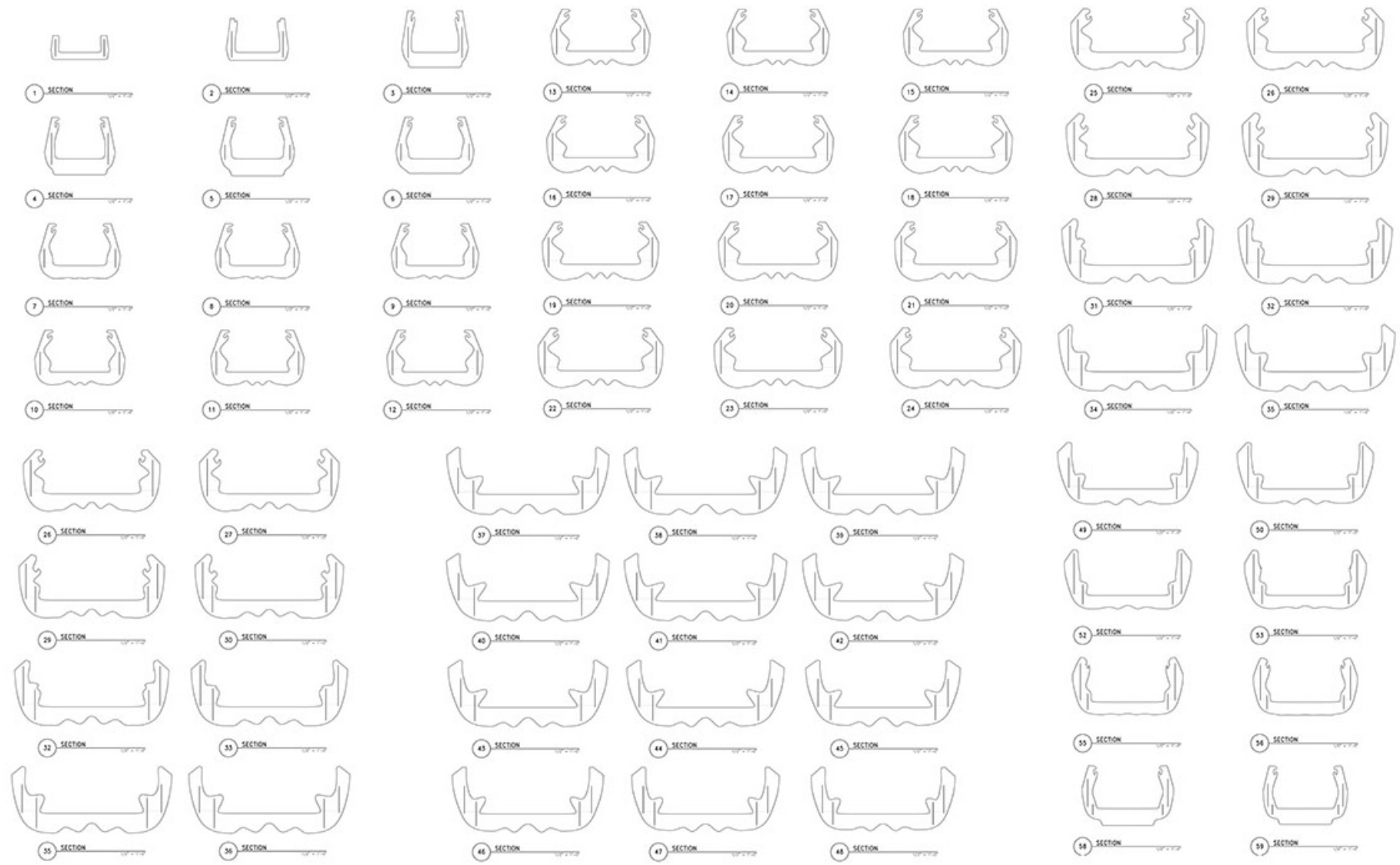

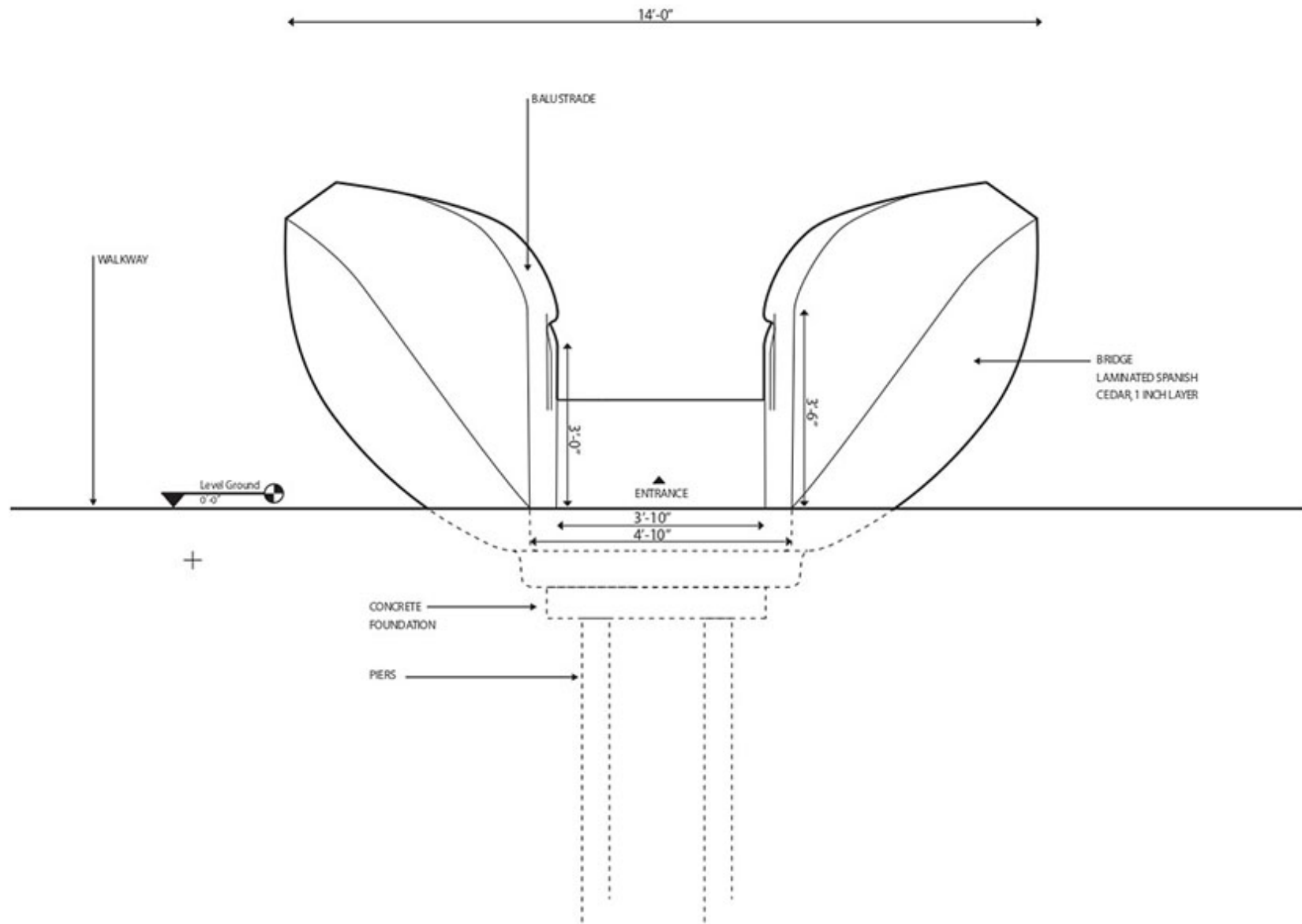

06 Elevation North
NTS

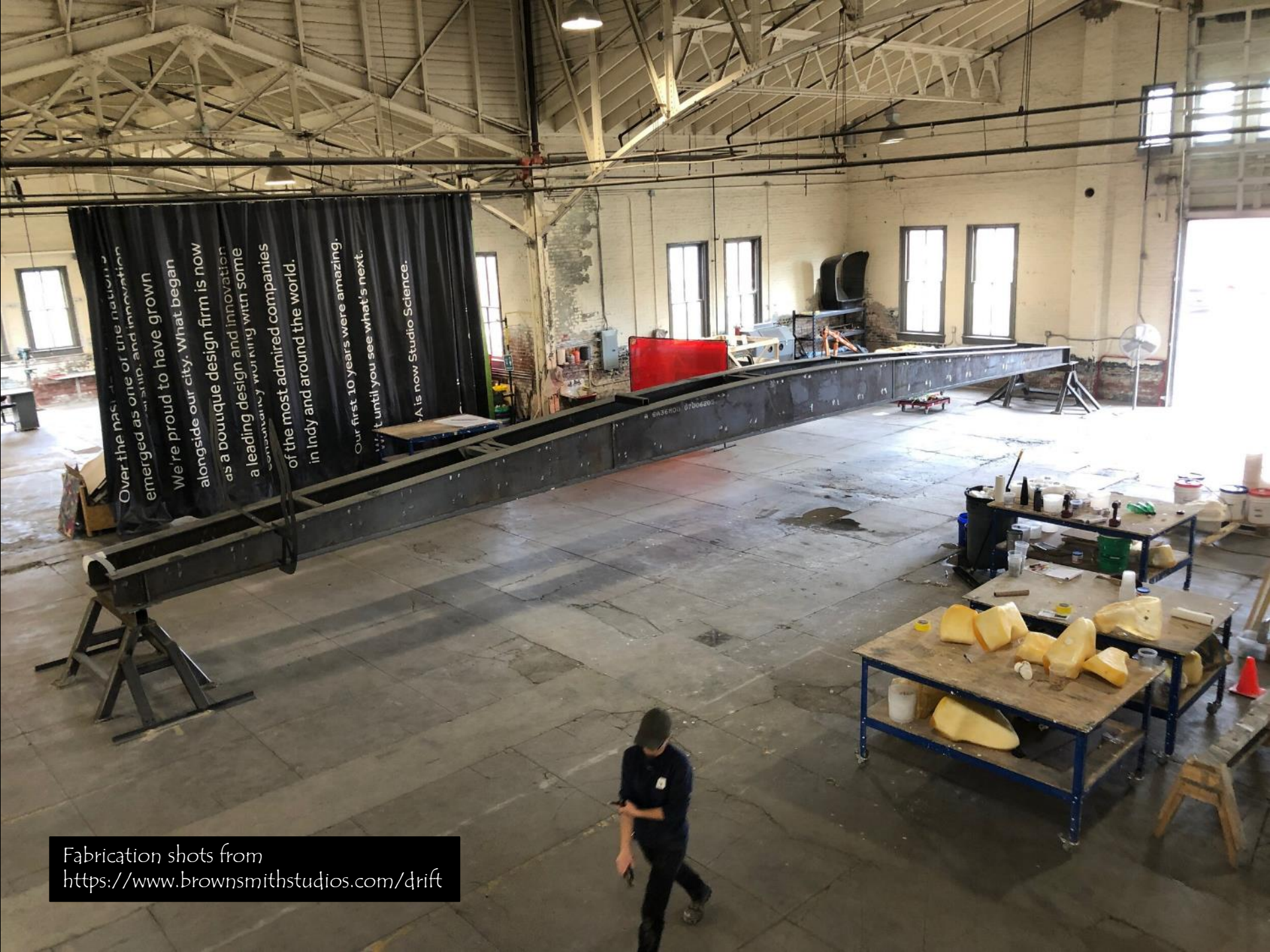

Fabrication shots from
<https://www.brownsmithstudios.com/drift>



ie our city. What began
g design and innovation
ancy working with some
and a lot of the world.

W. Studio Science





TRUSS / SUPPORT BELOW



Canoe Bridge
Vancouver, B.C.















Westgate Cycle Bridge
Auckland, New Zealand













Pedestrian Bridge La Villette
Paris, France



CABARET ← SAUVAGE

P

POURCHERON









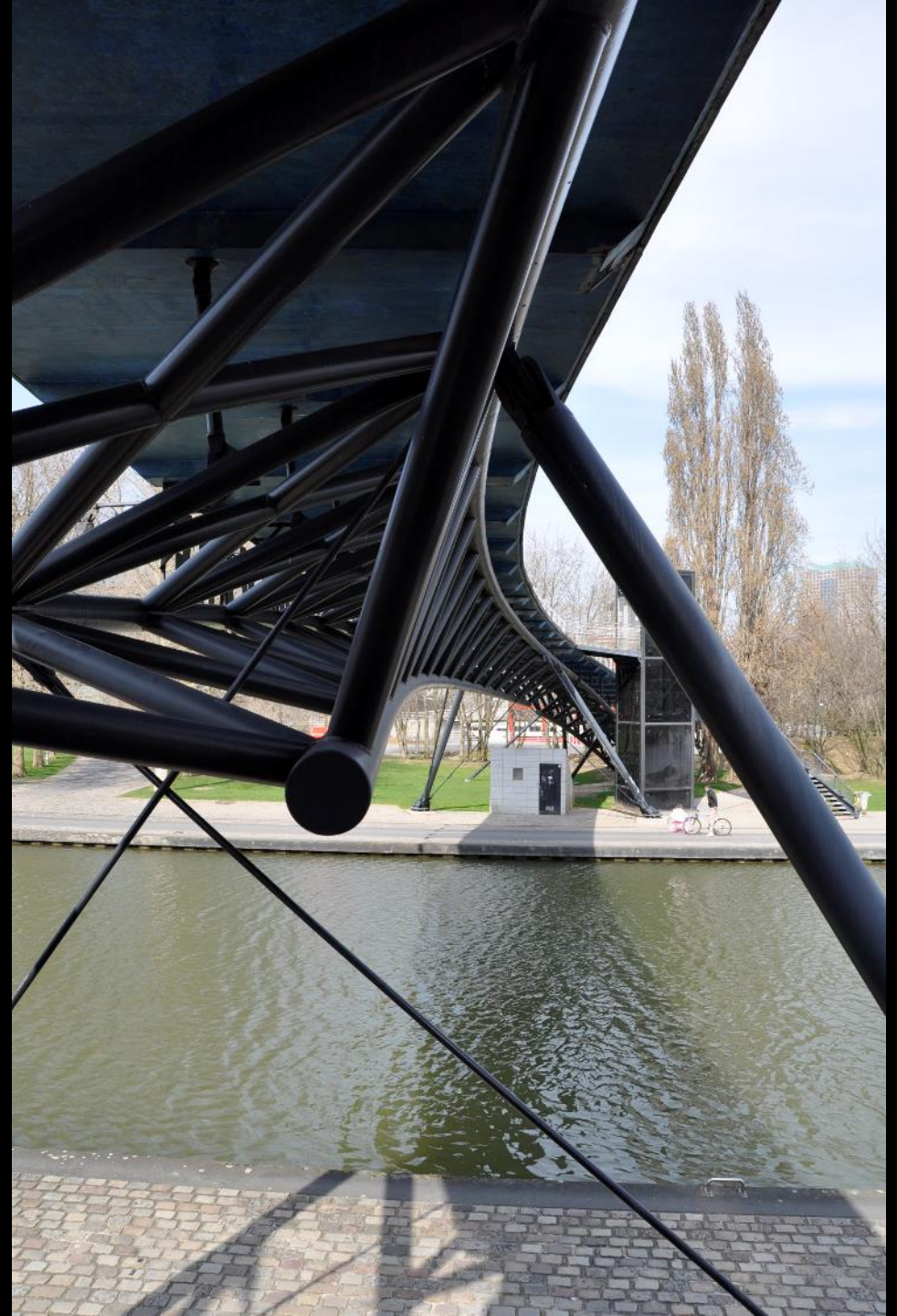





Pedro e Ines Bridge
Coimbra, Portugal







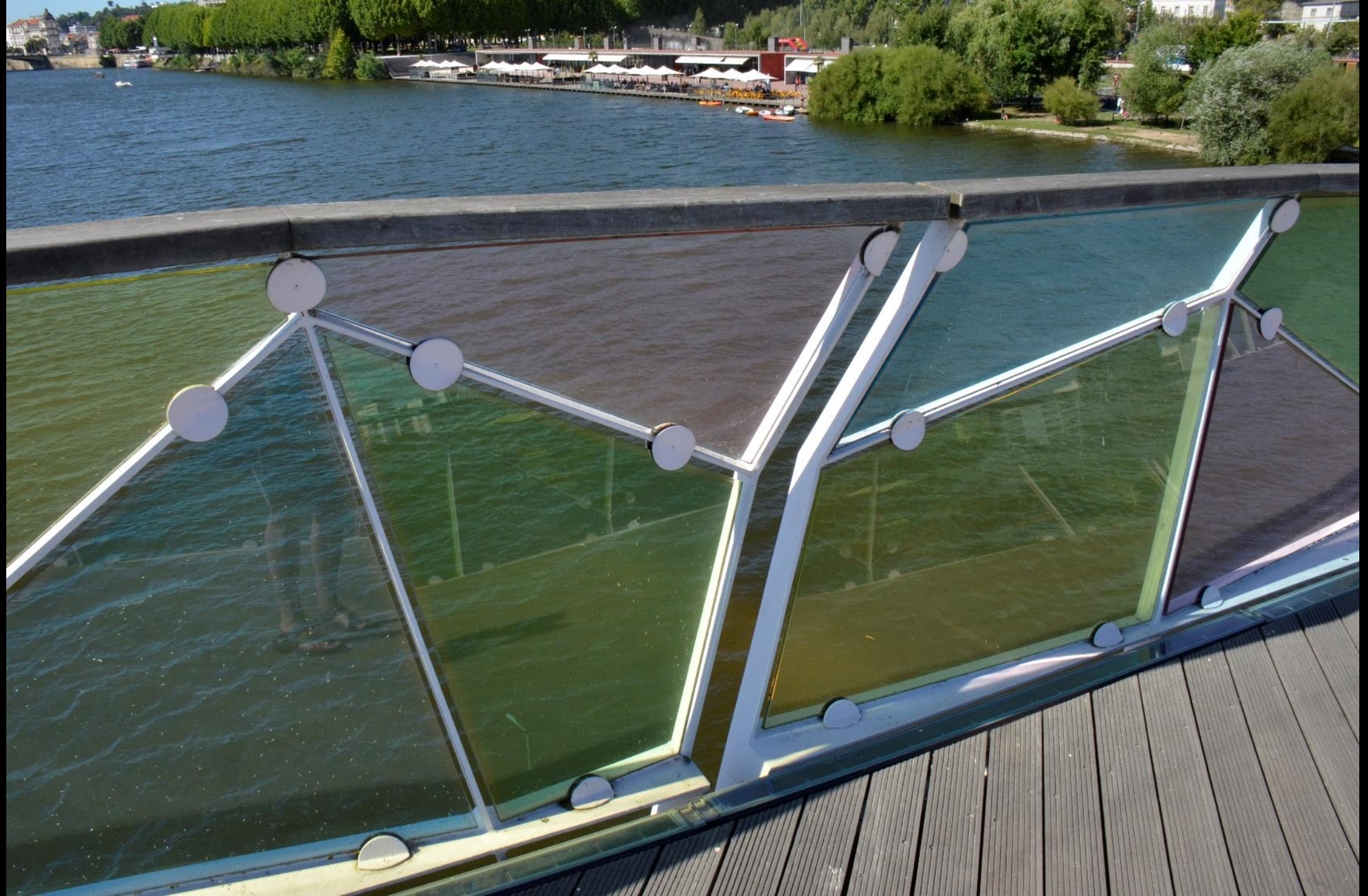



Simone Beauvoir Footbridge
Paris, France



mk2

Wissenschaftszentrum für Politik

WASSER









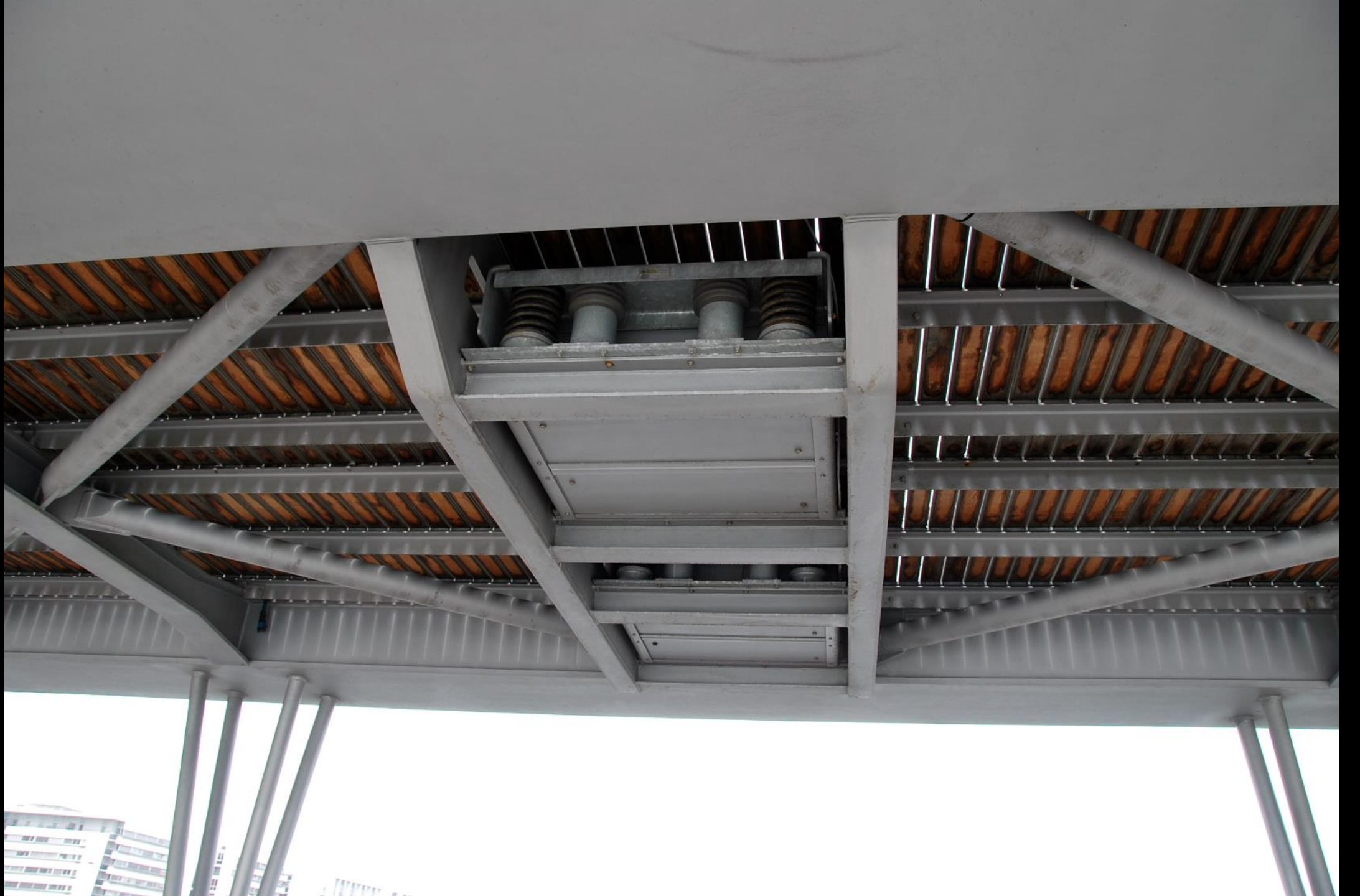

KINETIC - MOVING



Lift Bridge
Auckland, New Zealand

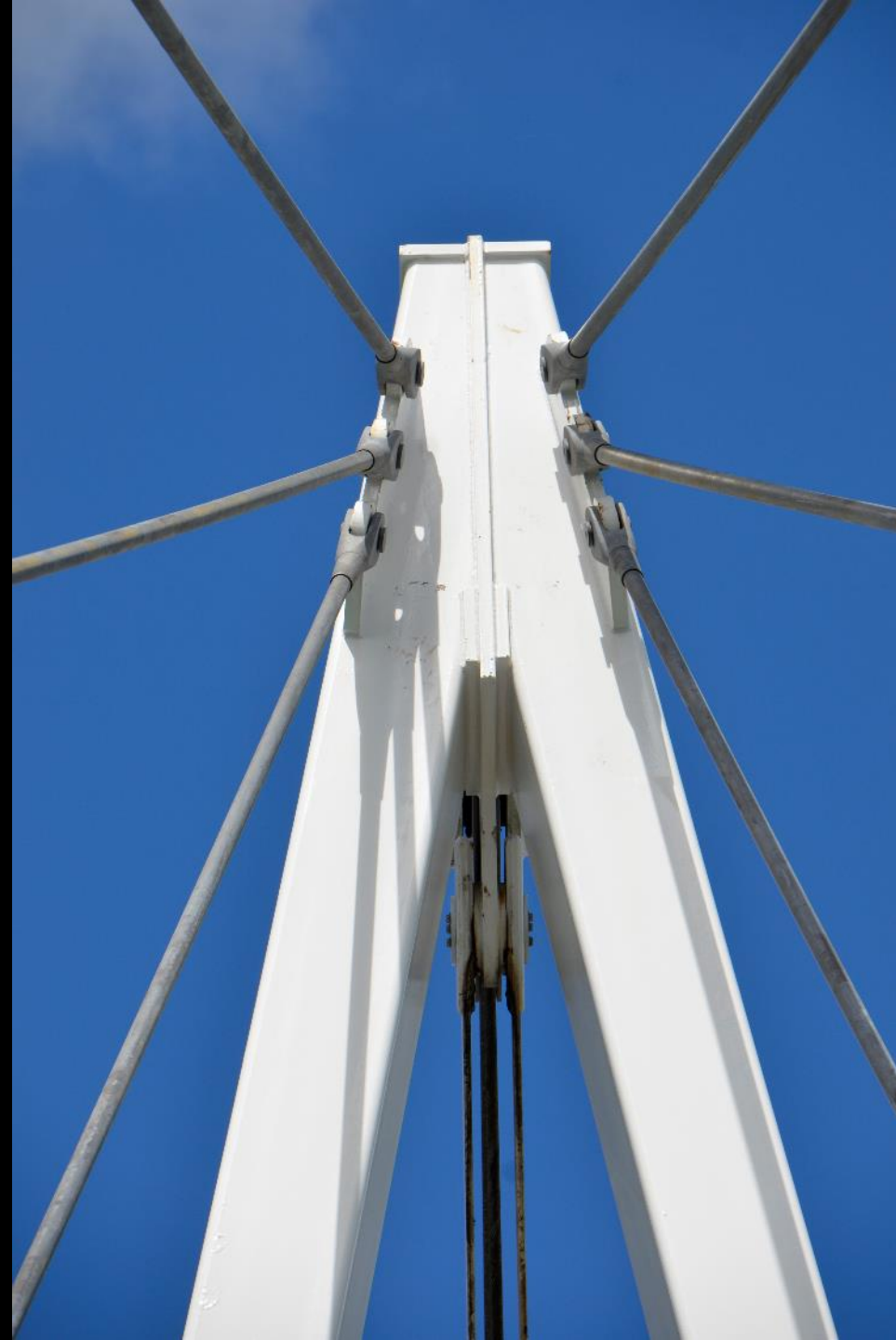





Gateshead Millennium Bridge
Newcastle, England











Not Terri's photo



Curling Lift Bridge Paddington Basin
London, U.K.

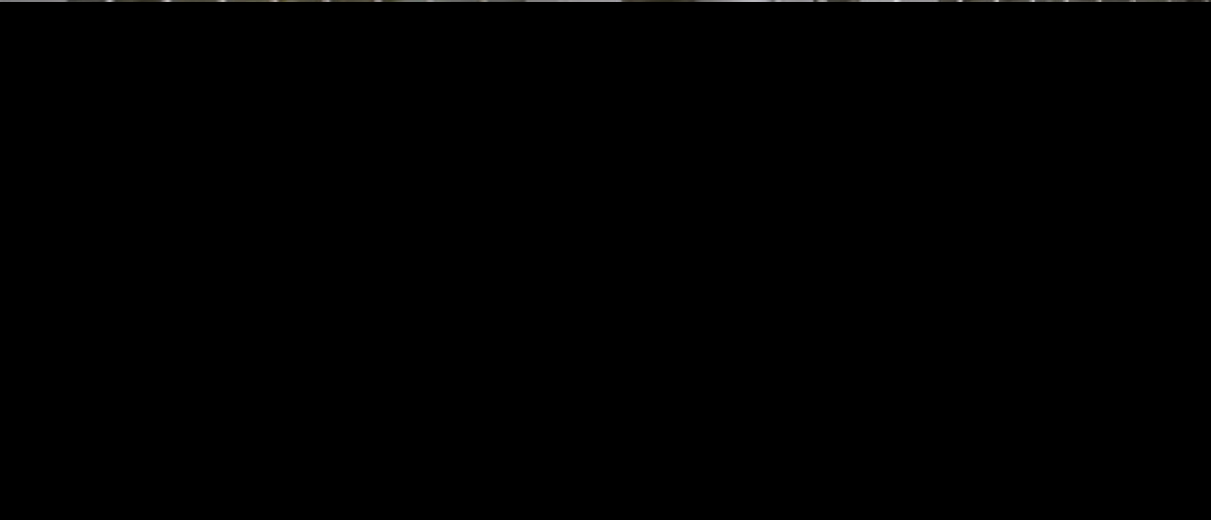
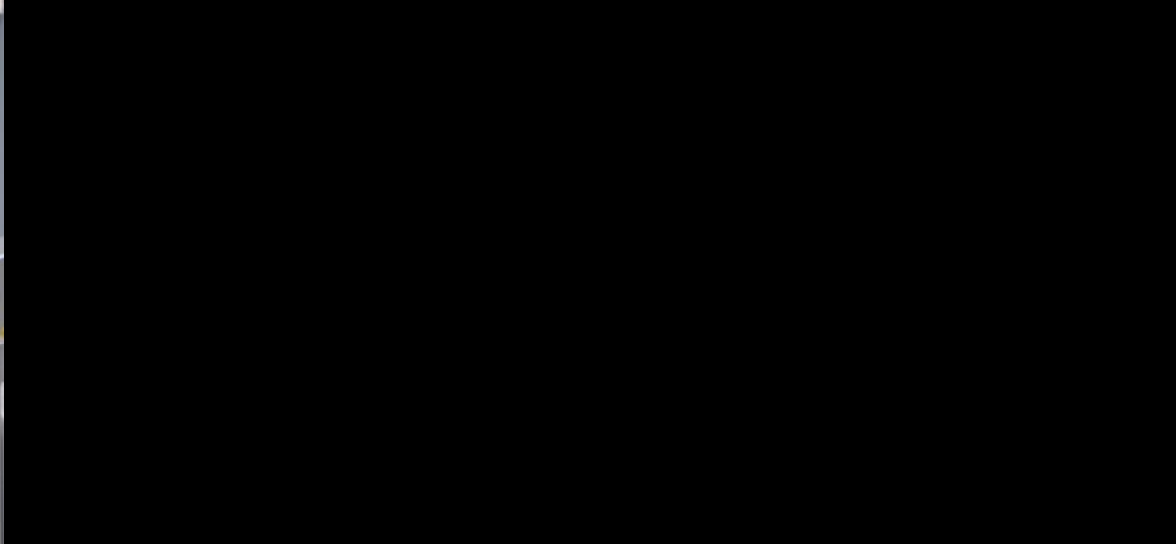



Not Terri's photo

TENSION



Millennium Bridge
London, U.K.



Street Art
TATE







