

# ROOFING TECHNOLOGY

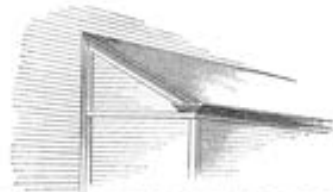


# Why do we need to be concerned about roofs?

- Roof and membrane failures are the most often litigated parts of a building
- good detailing is paramount
- never use materials or systems that have not been “approved” or tested by a reputable agency

# GENERAL ROOFING TERMS

FROM THE INTERNATIONAL LIBRARY OF TECHNOLOGY, 33C, 1909



SHED, PENT OR LEAN-TO ROOF



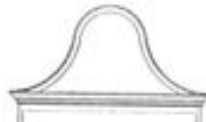
MANSARD ROOF



LOUVRE  
VENTILATOR



GABLE ROOF



OGEE ROOF



SURMOUNTED DOME



CURB OR  
GAMBREL ROOF



SEMICIRCULAR DOME



HIP ROOF



SEMICIRCULAR OR  
BARREL ROOF



ELLIPSOIDAL DOME



HIP AND VALLEY ROOF



SEGMENTED DOME



DORMER  
WINDOW



BELL  
DOME



GRECIAN PITCH



ROMAN PITCH



A SQUINT



EYEBROW DORMER

ELIZABETHAN PITCH



GOthic PITCH

It is important to be familiar with the general roofing terms regarding their general shape and configuration.

# ROOFING TYPES:

THE TWO PRIMARY TYPES OF ROOFING WE MUST CONSIDER ARE **FLAT** AND **PITCHED**:

**Flat roofs** are those slope is **LESS THAN 1 in 4** and use waterproof membranes (also called Low Slope)

**Pitched roofs** have slopes of **1 in 4 or GREATER** and generally use shingles

# Roof Type Selection

- Depends on building use
- Span
- Structural materials
- Need to shed water or snow
- Need to provide overhangs for shading
- Need to provide overhangs to protect the wall materials
- Need for insulation (and type of insulation to be used - batt vs foam/rigid)
- Incorporation of skylights or roof glazing

## Common Fact

- Flat roofs are prone to leaking
- Leaks are difficult to find as the entry point for the leaking water is usually not near the point of apparent leakage
- Sloped roofs tend to stay watertight if properly built (pay attention to ice dams...)

# Pitched Roof Materials:

## SHINGLES:

- asphalt, sawn wood, shakes, slate, clay tiles or concrete tiles

## THATCH:

- bundles of leaves, reeds or grasses

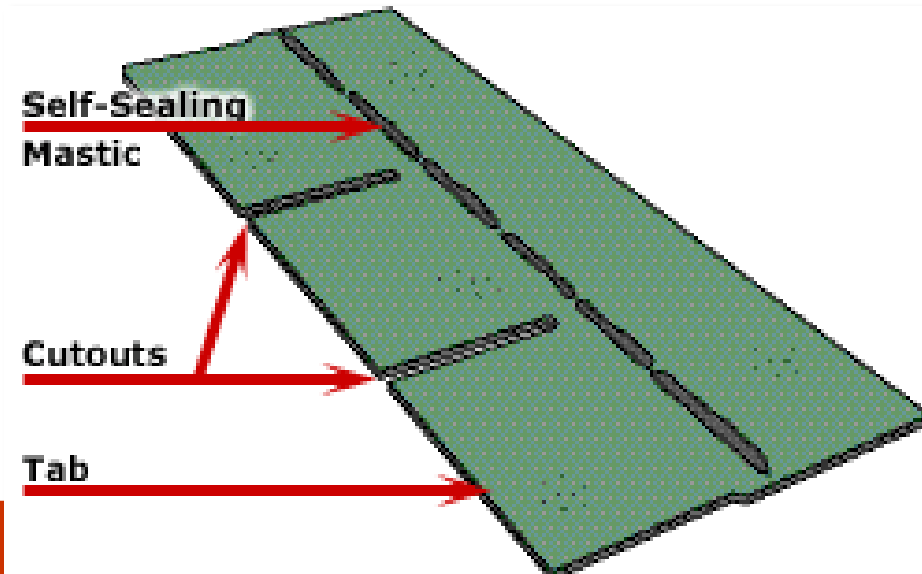
## ARCHITECTURAL SHEET METAL:

- lead, copper and terne (stainless steel or sheet steel) with flat or standing seams

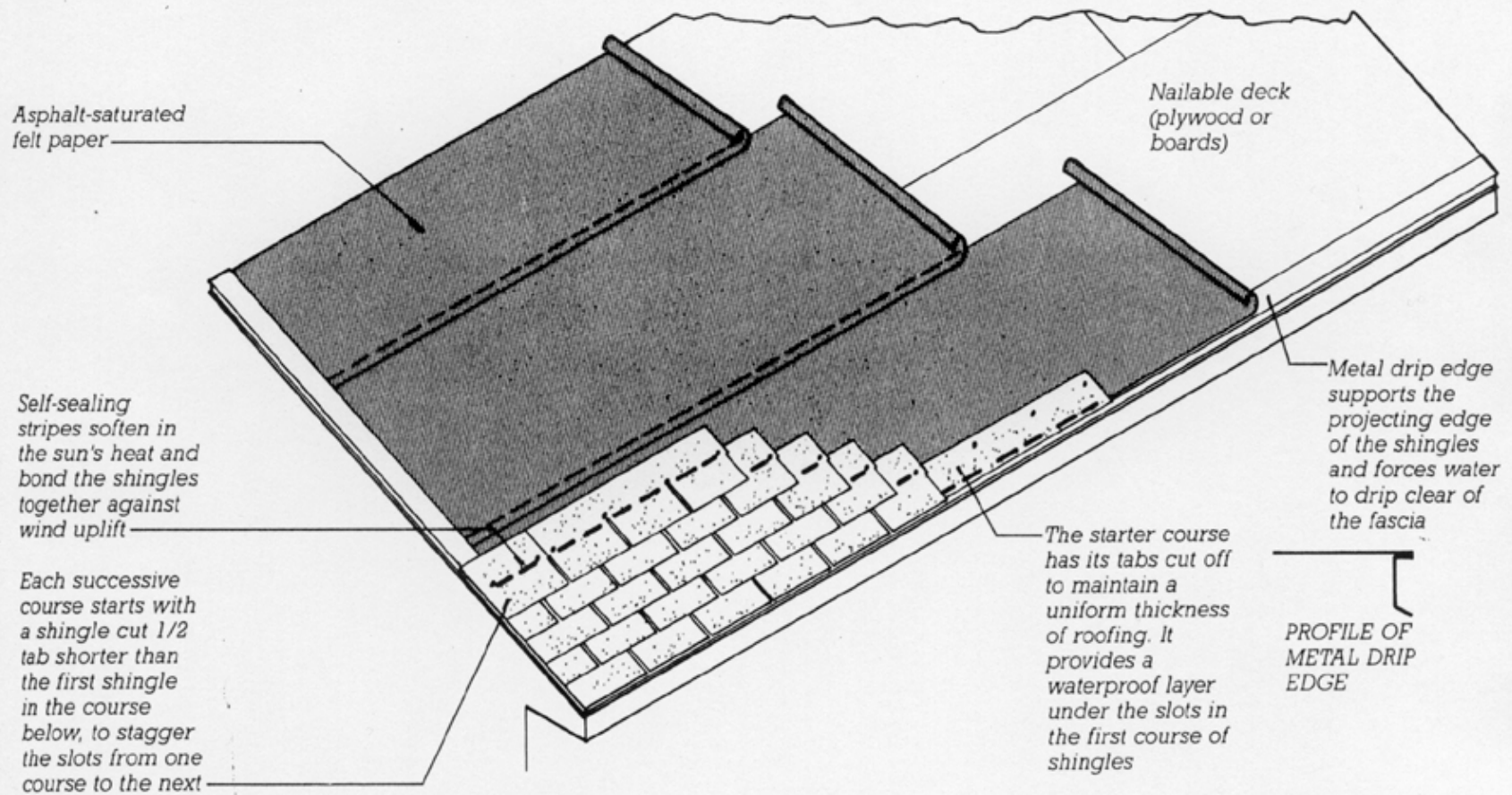
Terne is an alloy coating that was historically made of lead and tin used to cover steel, in the ratio of 20% tin and 80% lead. Currently, lead has been replaced with the metal zinc and is used in the ratio of 50% tin and 50% zinc.



The life span of an asphalt-shingle roof shingles is somewhere between 15 and 30 years, depending on the quality of the roofing shingles and the climate in your region. Wind can often cause as much damage as water, cold temperatures and sun.





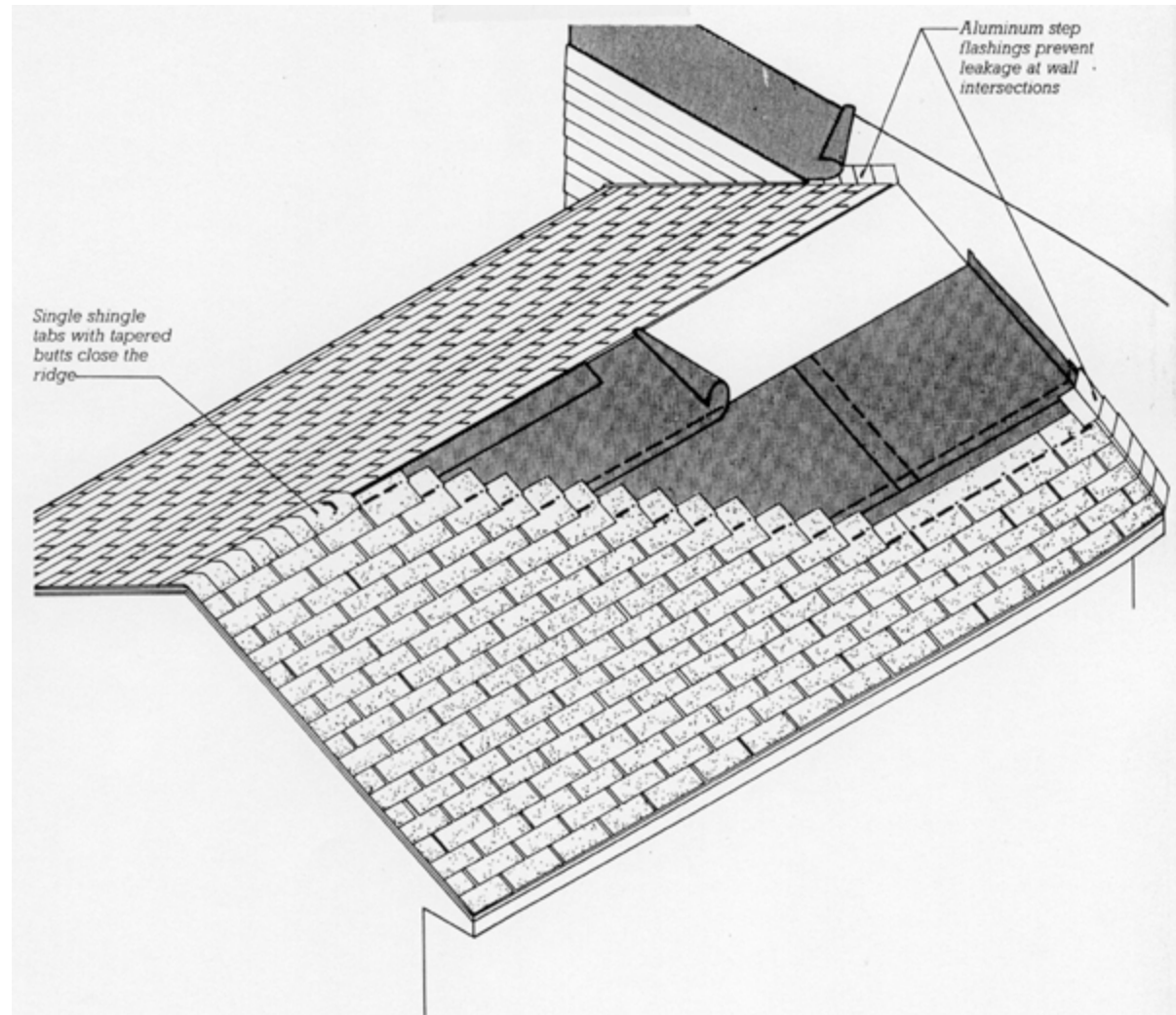


**FIGURE 13.42**

*Starting an asphalt shingle roof. Most building codes require the installation of a snow-melt barrier beneath the shingles at the eave in regions with cold winters. The most effective form of barrier is a 3-foot-wide (900-mm)*

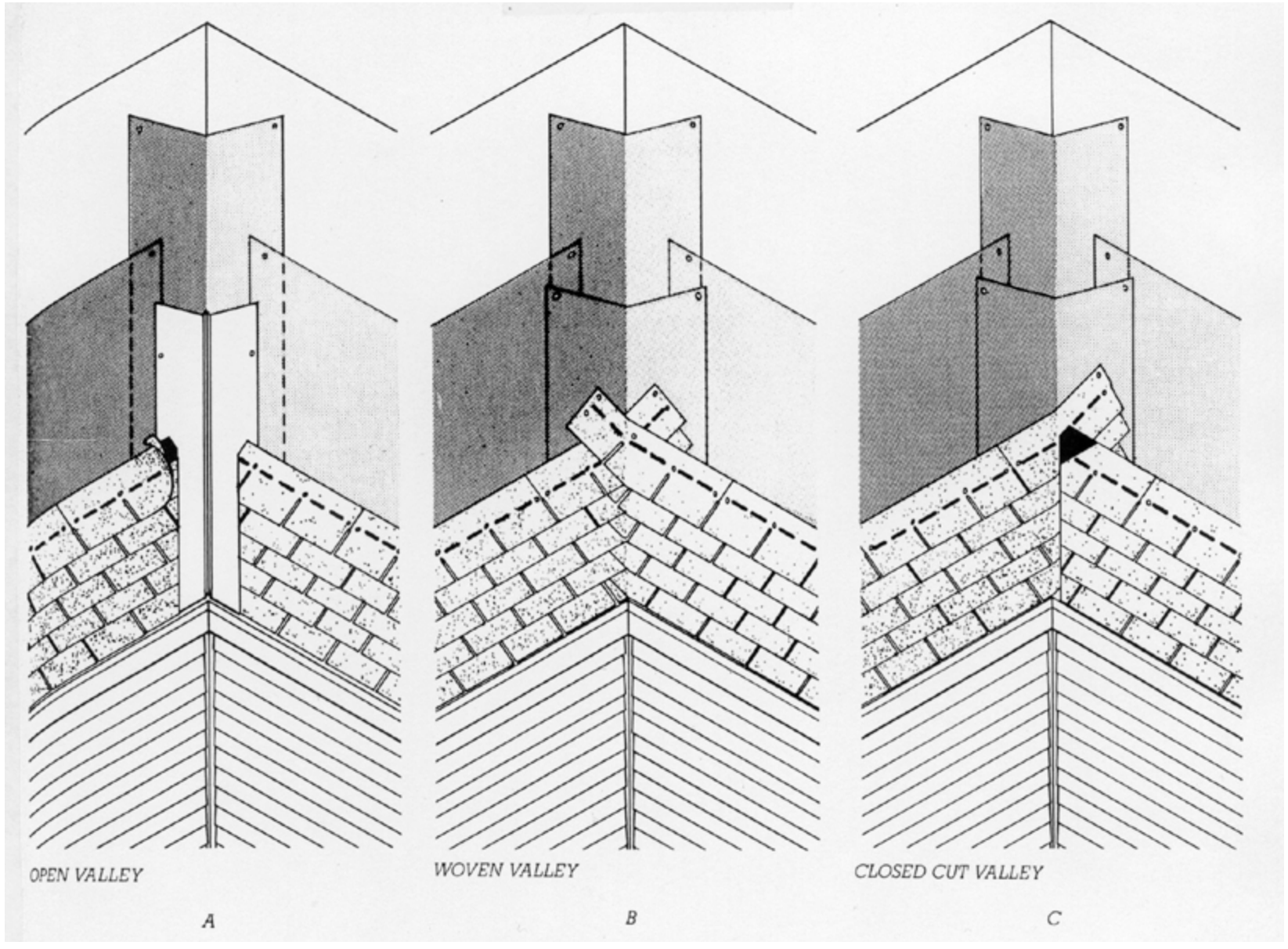
*strip of modified bitumen sheet that replaces the lowest course of asphalt-saturated felt paper. The bitumen self-seals around the shanks of the roofing nails as they are driven through it.*

## Pitched Roof: Shingle Detail



**FIGURE 13.43**  
*Completing an asphalt shingle roof. A metal attic-ventilation strip is often substituted for the single-tab shingles on the ridge.*

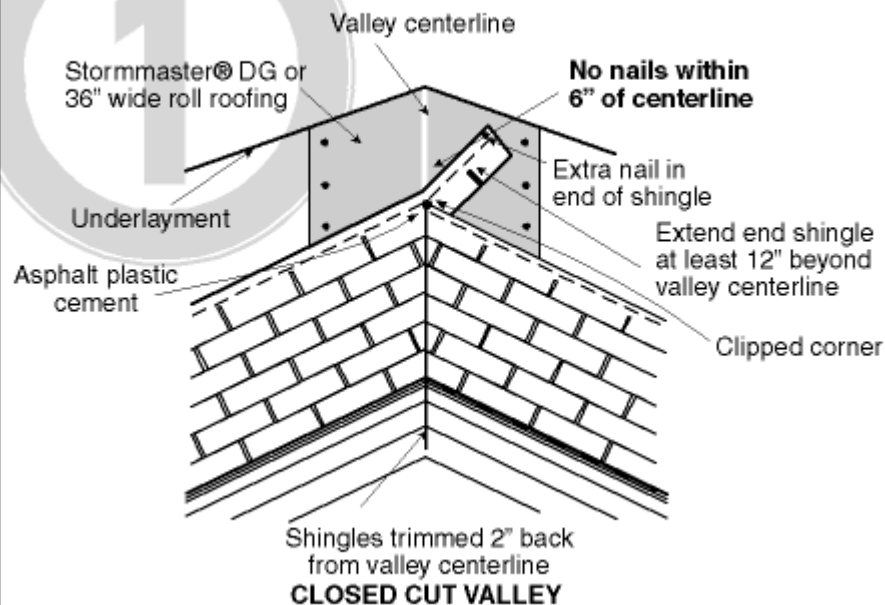
## Pitched Roof: Shingle Ridge Detail



Pitched Roof: Shingle Valley Detail

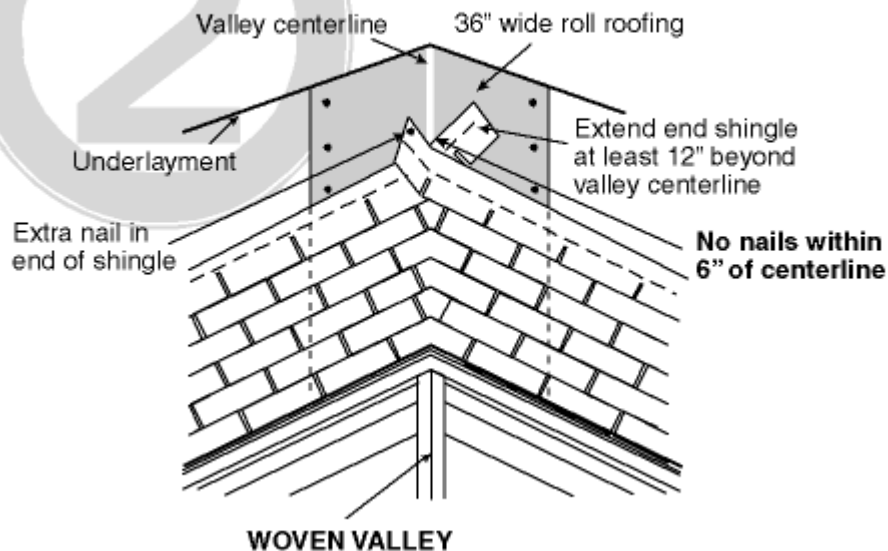
## CLOSED CUT VALLEY

DIAGRAM 1



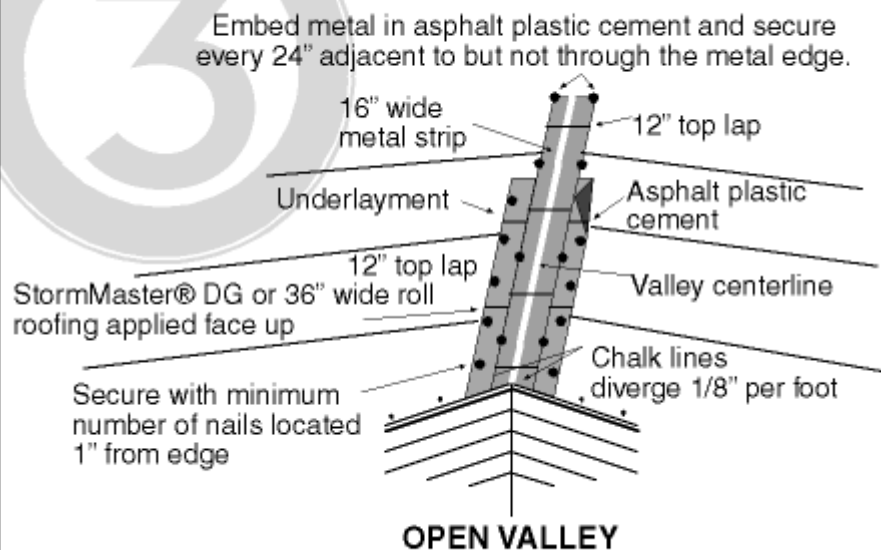
## WOVEN VALLEY

DIAGRAM 2

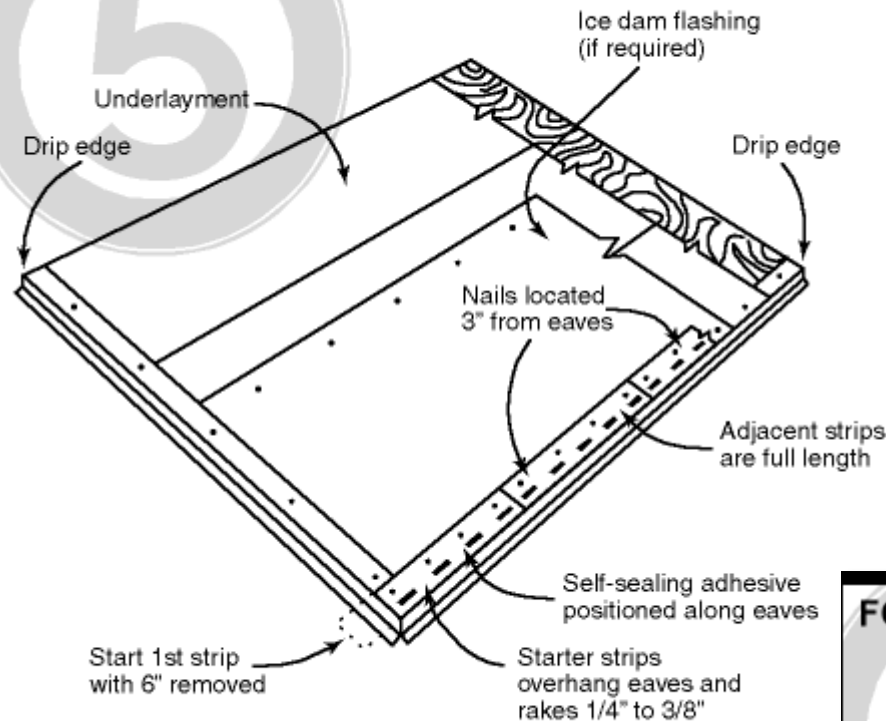


## OPEN VALLEY

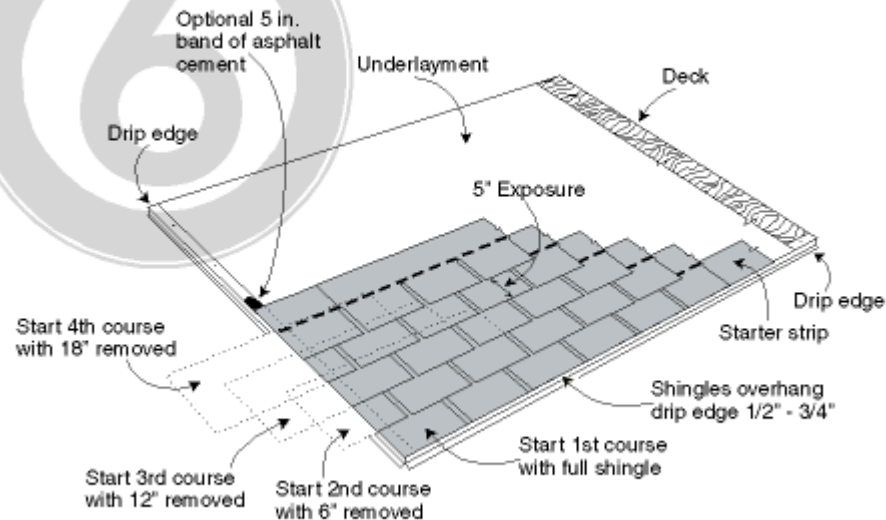
DIAGRAM 3



STARTER COURSE

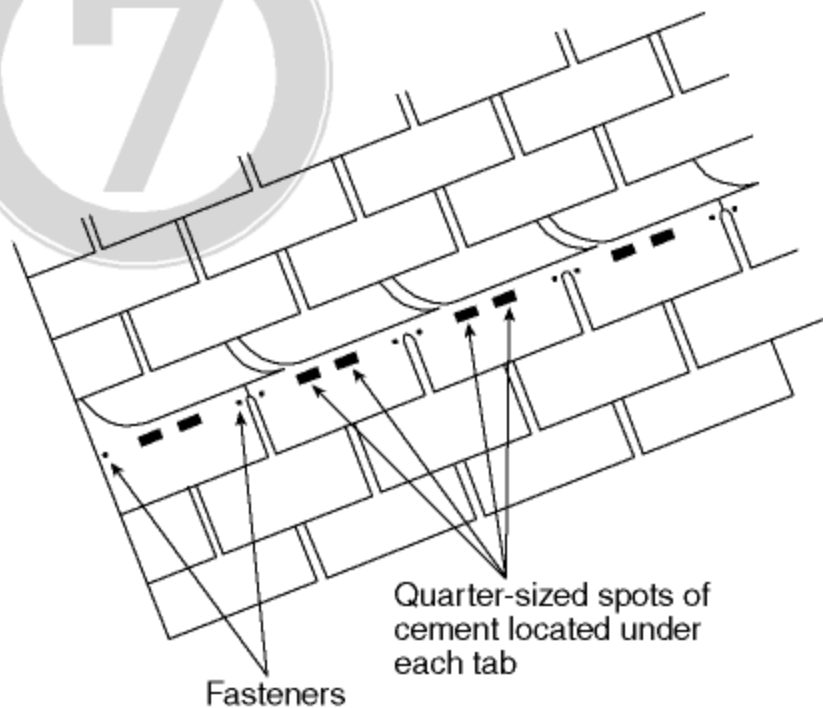


FOURTH COURSE



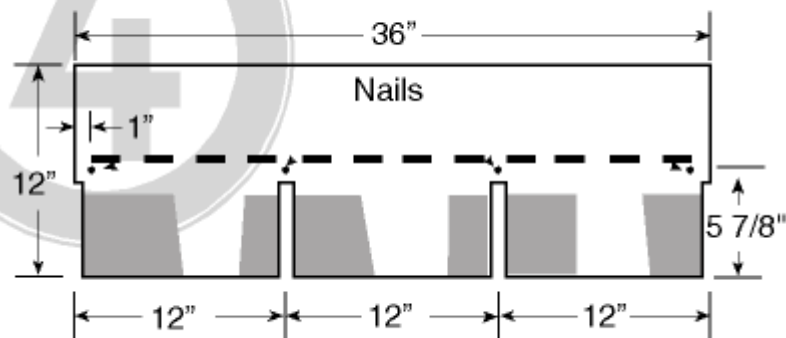
## CEMENT APPLICATION

DIAGRAM 7



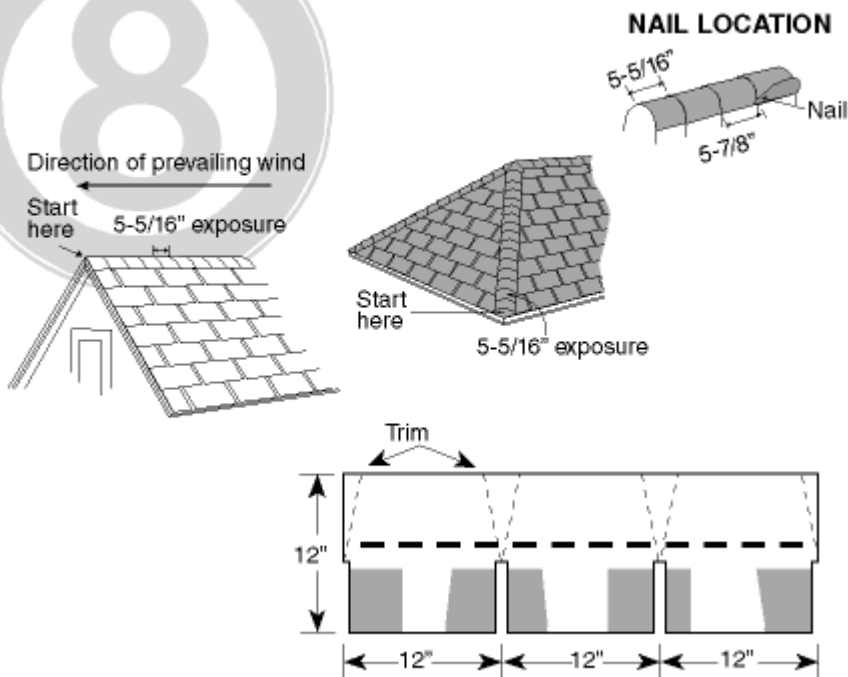
## FASTENER LOCATIONS

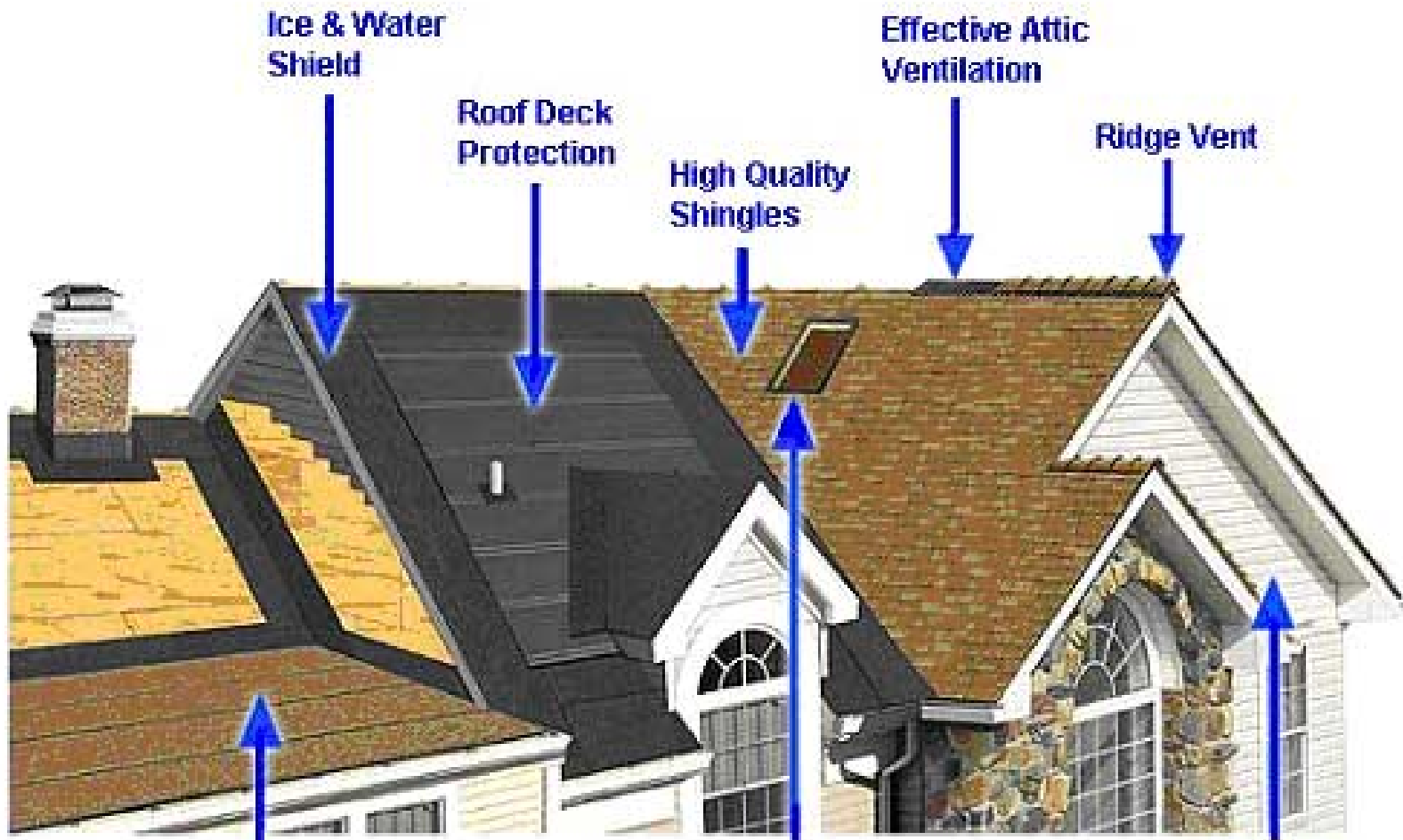
DIAGRAM 4



## HIP & RIDGE

DIAGRAM 8





**Ice & Water Shield**

**Roof Deck Protection**

**High Quality Shingles**

**Effective Attic Ventilation**

**Ridge Vent**

**Rubber Membrane**

**We Install Replacement Windows And Skylights!**

**We Install Wood & Fiber Cement Siding!**



Ice and water shield being installed at the bottom meter of a shingled roof. Note that it is lapped UNDER the roofing paper to promote drainage. This extra membrane is thicker and more durable than roofing paper and is meant to prevent water leakage due to "ice dams" at the end of the roof.



## Eave protection against ice dams

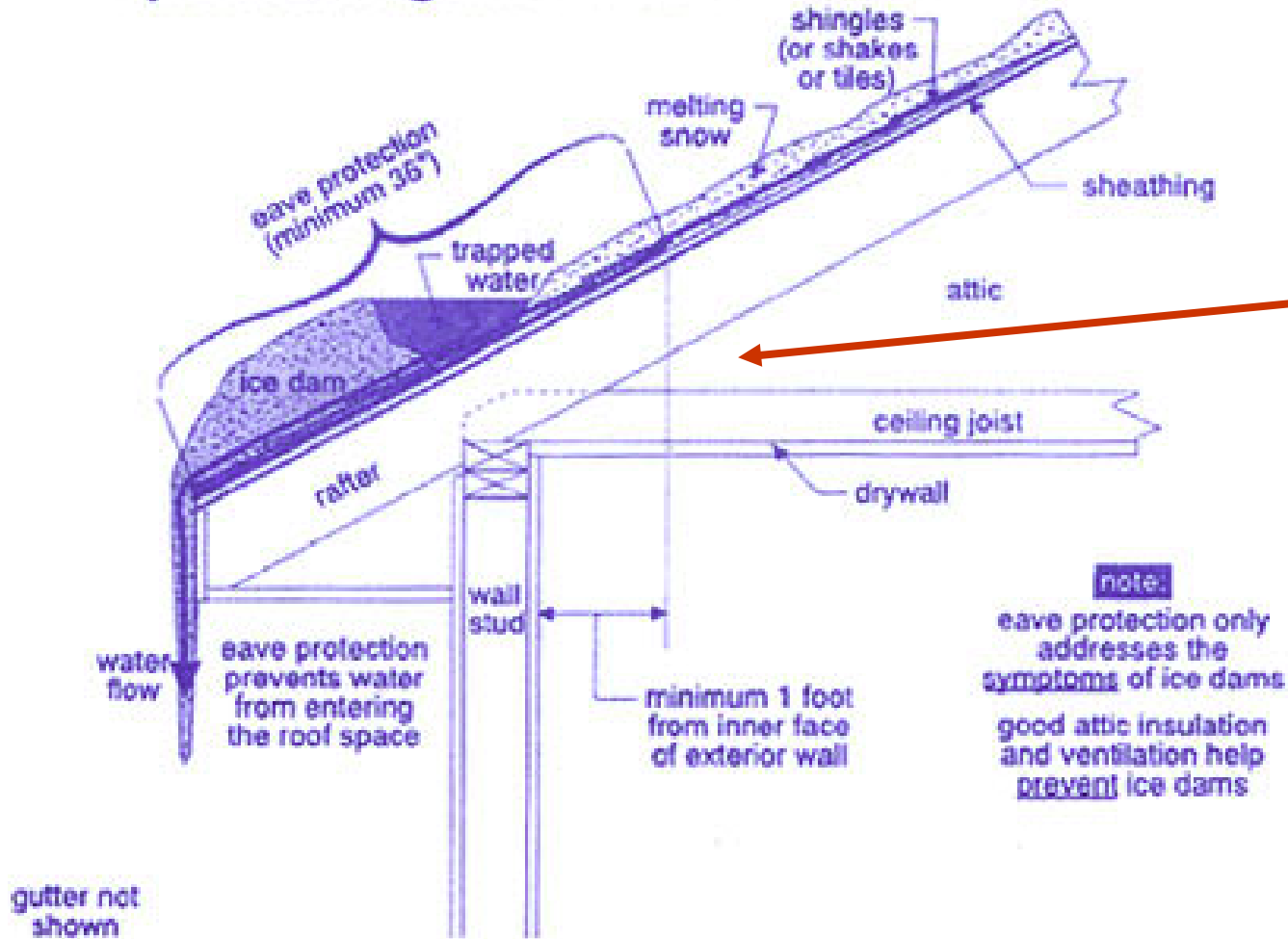


Figure 5. Ice Damming

Note:  
insulation  
missing in  
this  
diagram!!

So important  
to watch for  
technical  
mistakes on  
diagrams in  
books!

**Roof felt**

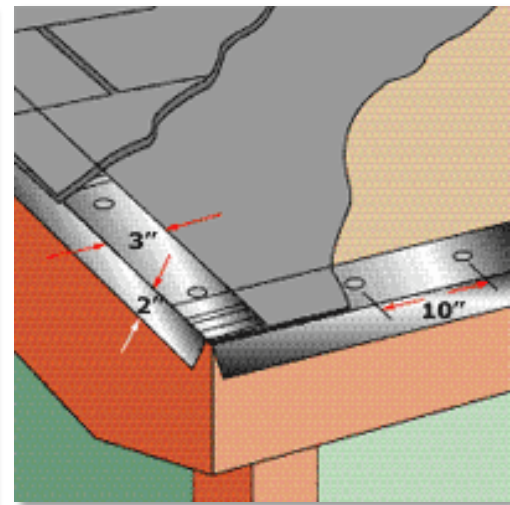
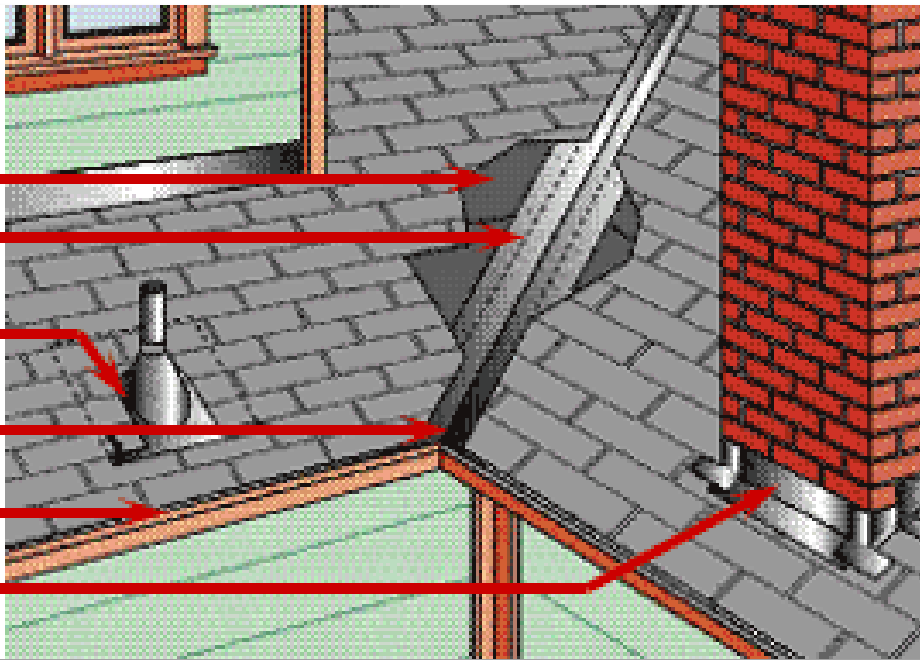
**Shingle line**

**Vent pipe flashing**

**Valley flashing**

**Drip edge**

**Chimney base  
flashing**



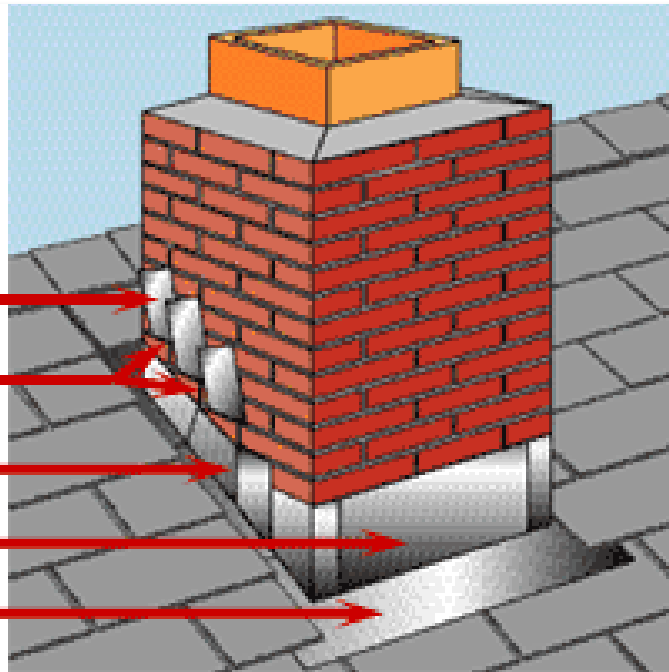
**Cap flashing (shown  
bent upward)**

**Mortar joints**


**Step flashing**

**Cap flashing**

**Base flashing**



Ashphalt  
flashing details

A photograph showing two construction workers on a roof. On the left, a worker in white shorts is kneeling and using a power tool on a wooden structure. On the right, a worker in a red cap and grey pants is kneeling on green shingles, working on a wooden saddle. The background features trees and a body of water.

A saddle is used to divert water around the chimney

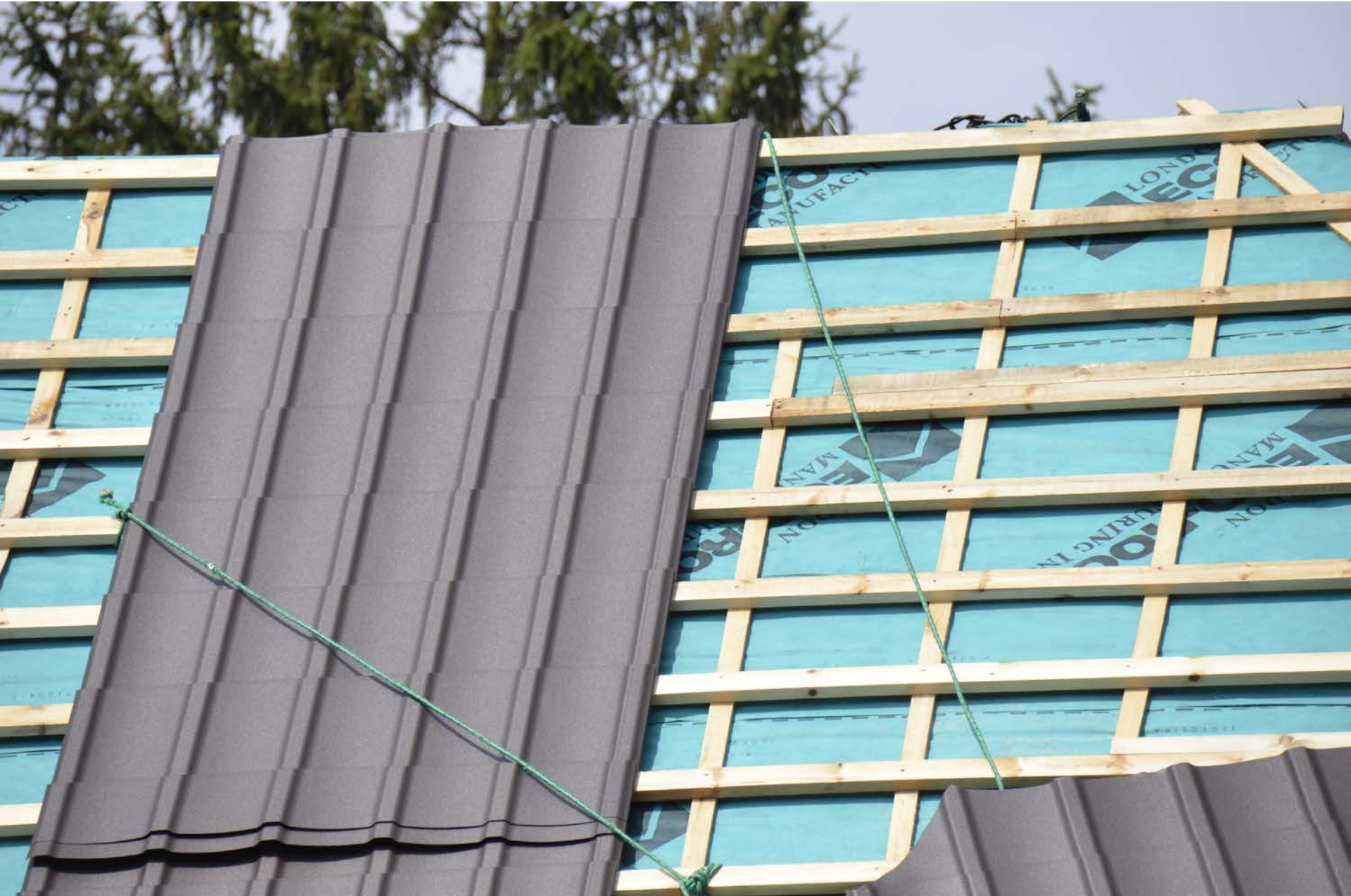


Contemporary tile look roof with underlayment



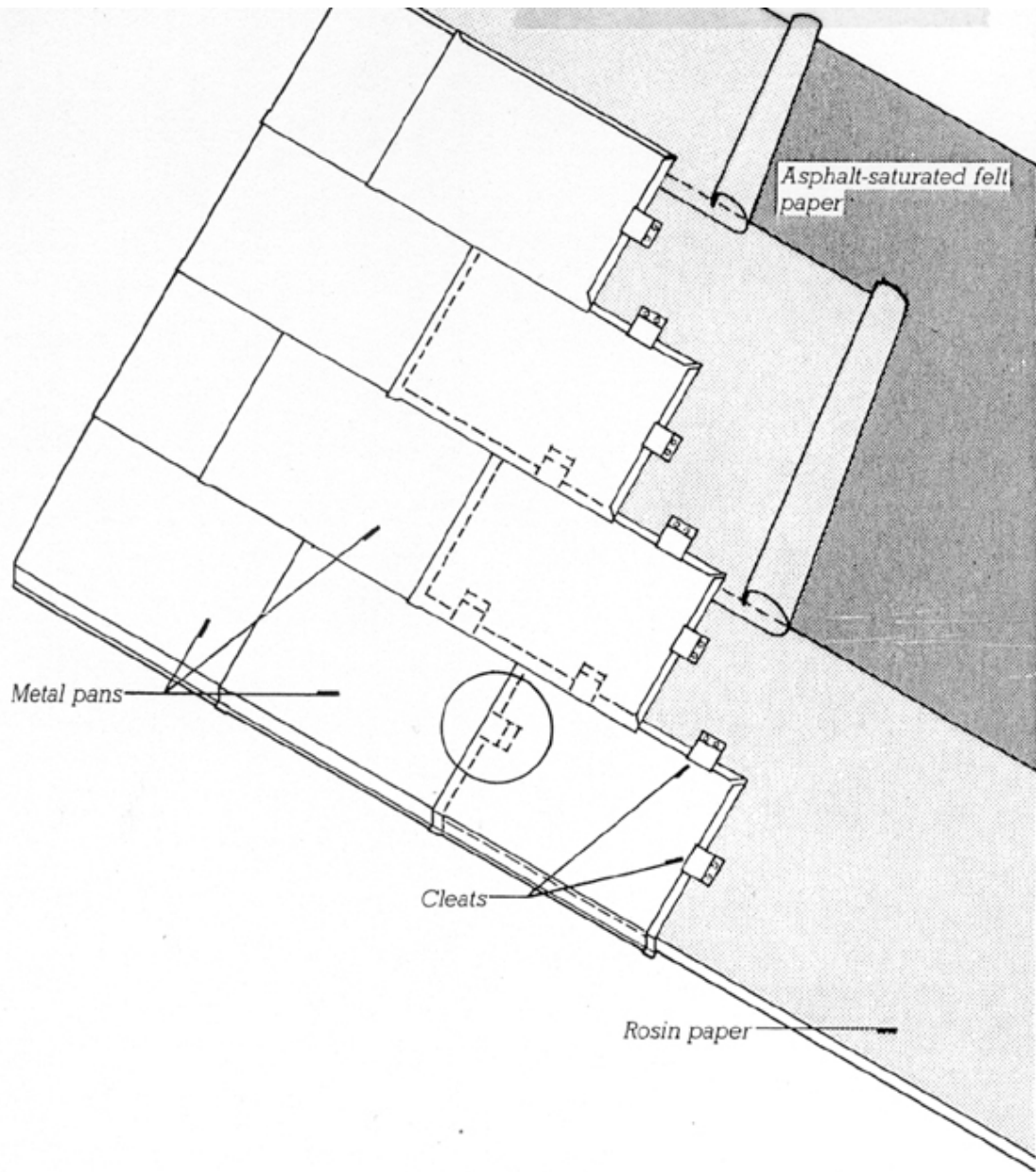
Larger sheet product







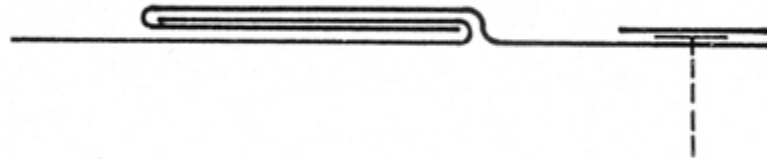




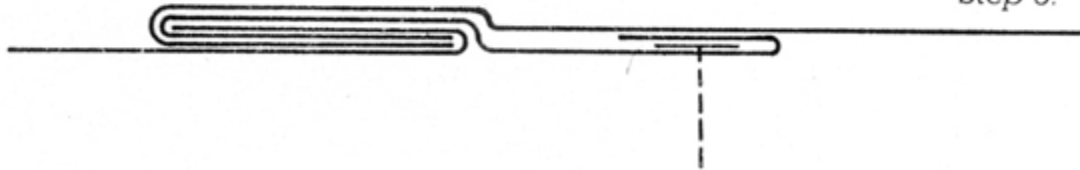
**FIGURE 13.50**  
*Installing a flat-seam metal roof. The three diagrams at the bottom of the illustration show the three steps in creating the seam, viewed in cross section. The cleats, which fasten the roofing to the deck, are completely concealed when the roof is finished.*



*Step 1: Each pan is formed in the sheetmetal shop with folded edges.*



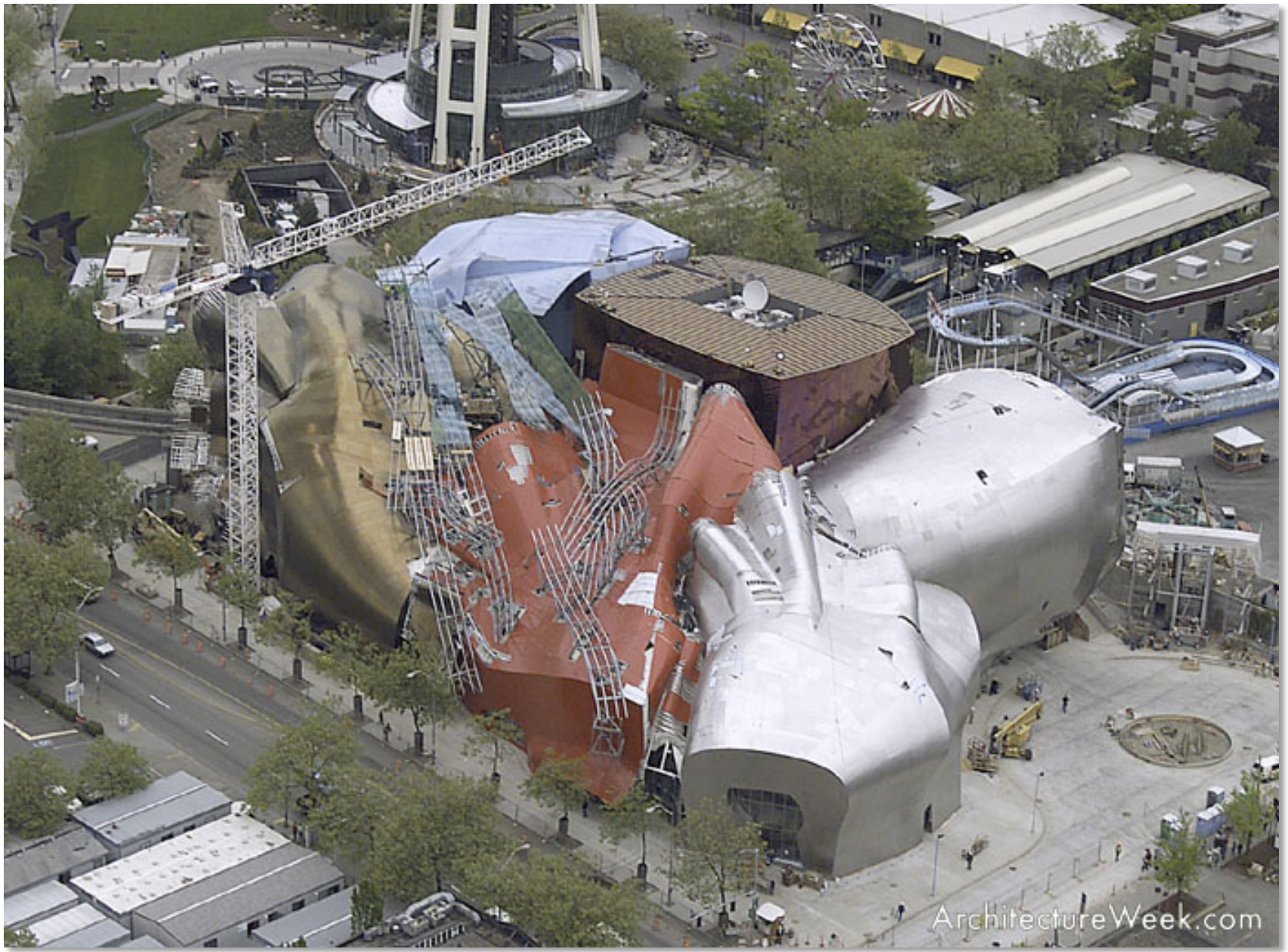
*Step 2: Sheet metal cleats interlock with the folded edges and are nailed to the deck. The cleat is folded back over the nail head to protect the pan.*



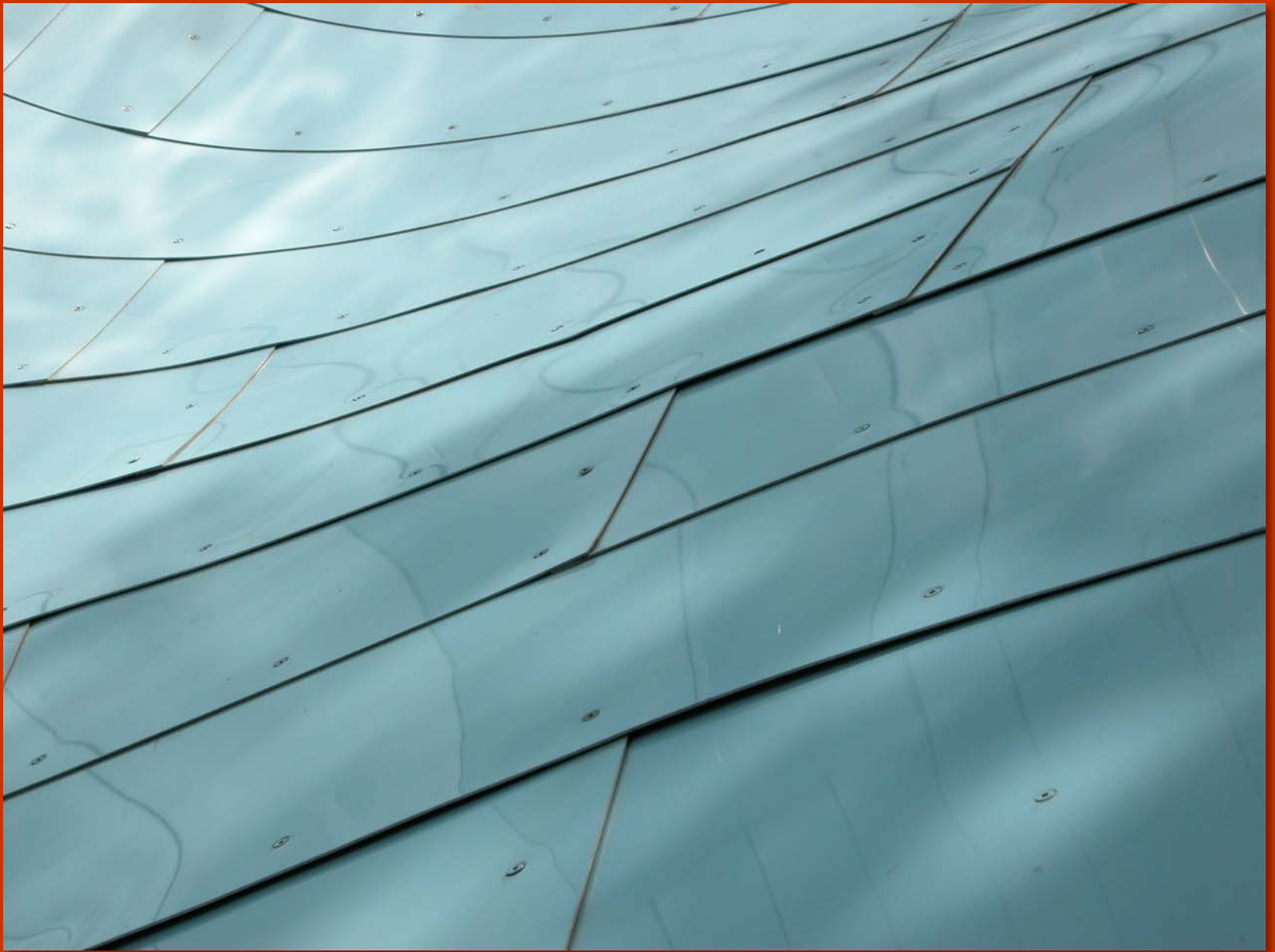
*Step 3: The next pan is interlocked with the first. When all pans are in place, the edges are beaten flat and soldered or sealed.*

## Metal Roof: Flat Seam





In projects such as Gehry's EMP in Seattle, the use of metal cladding blurs the distinction between what is the wall and what is the roof.





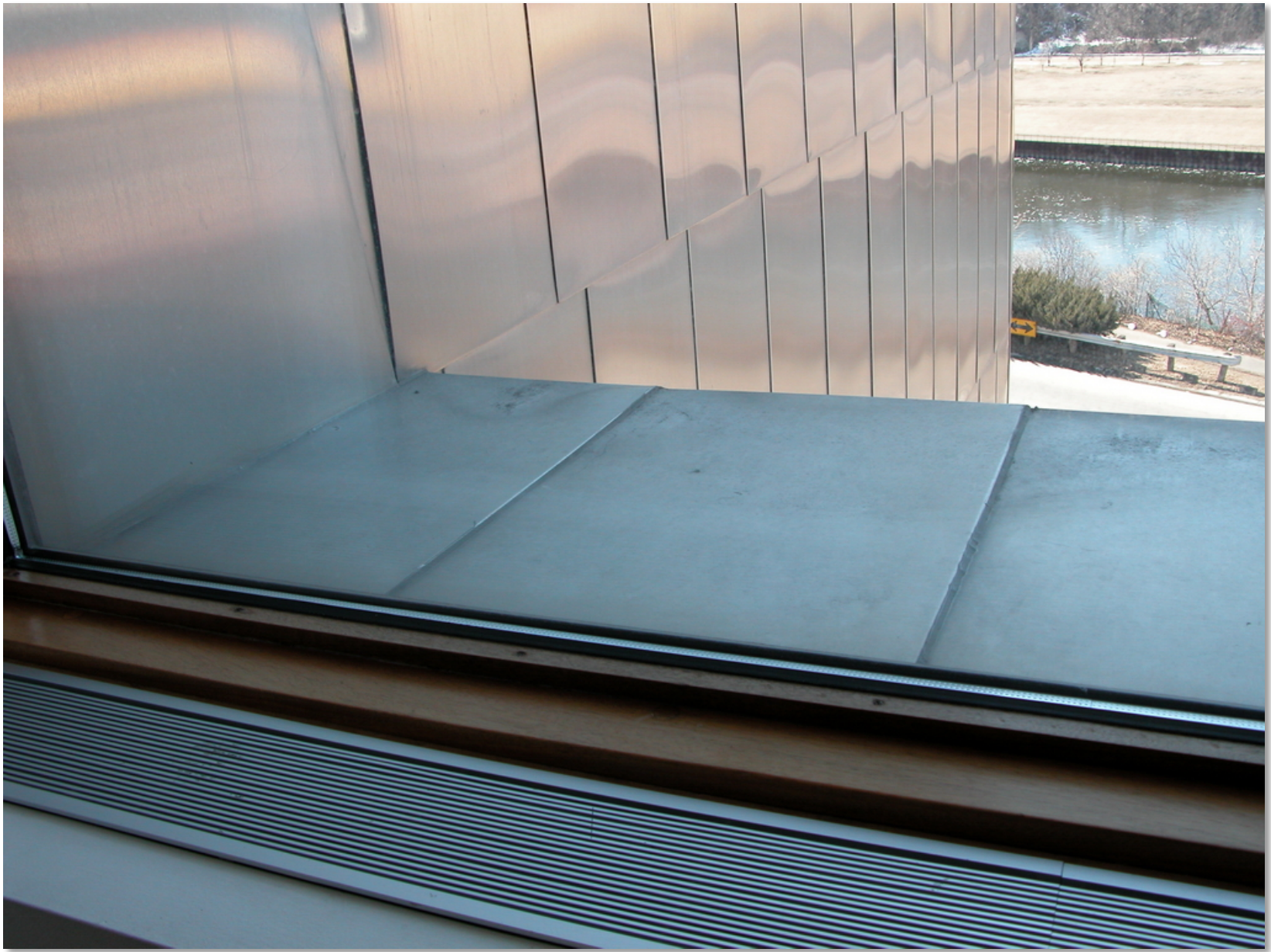


The Gehry Weisman Art Museum in Minneapolis used similar techniques for the stainless steel cladding panels.

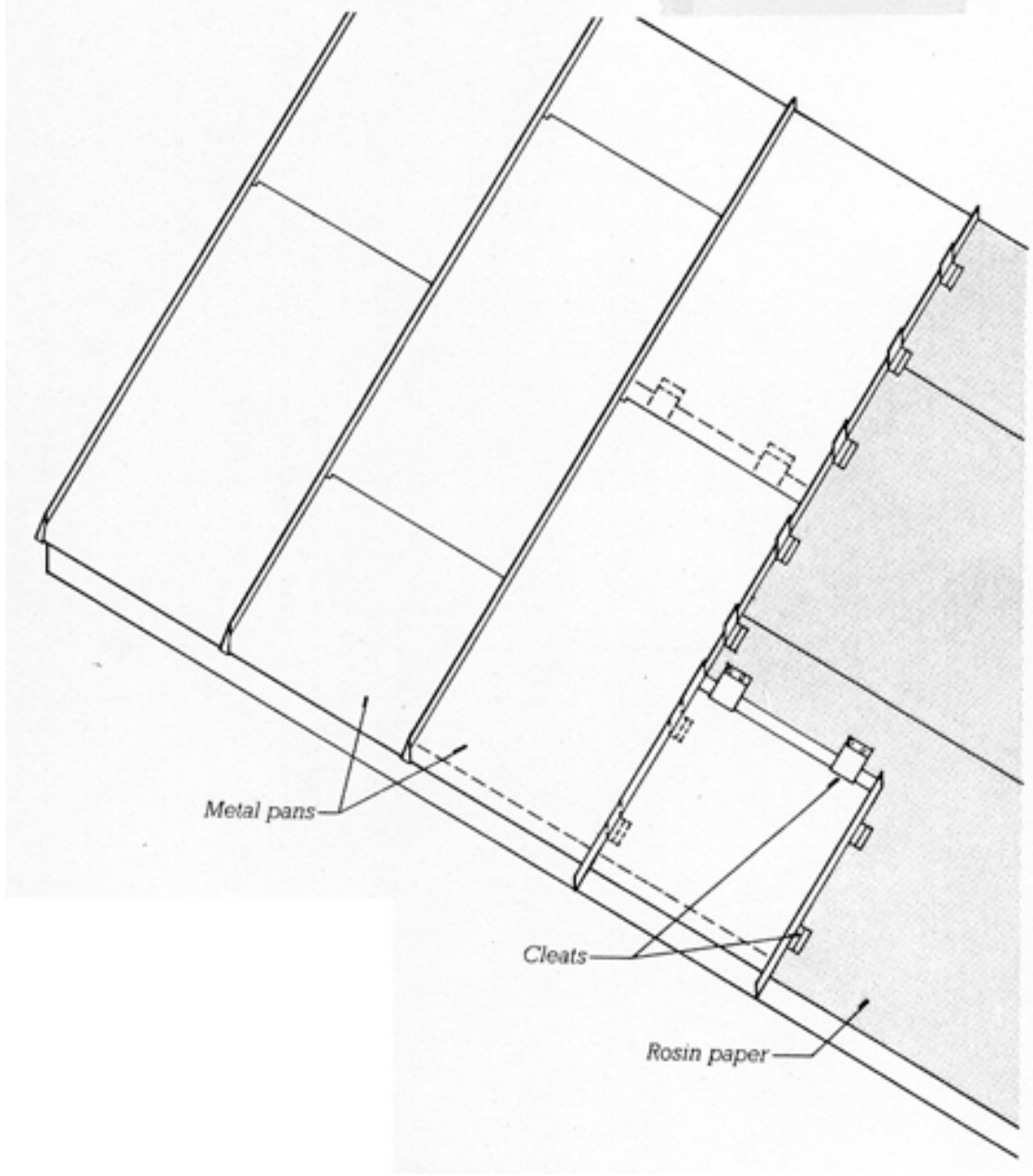


The Gehry Weisman Art Museum in Minneapolis used similar techniques for the stainless steel cladding panels.



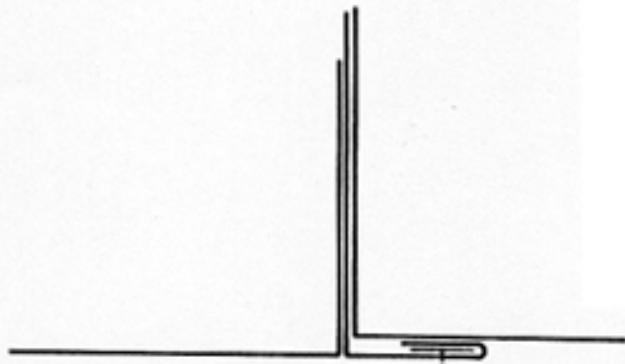


Although here you can see for the flat window ledge detail that a sealant has been used to prevent water penetration. NOT the best solution! Slope to drain is ALWAYS more reliable

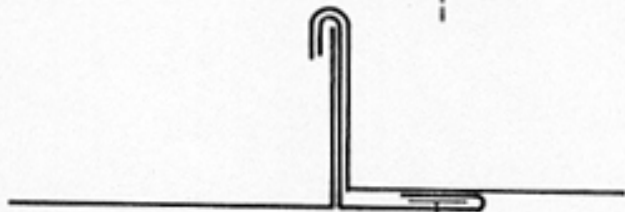


**FIGURE 13.51**  
*Installing an architectural standing-seam metal roof.*

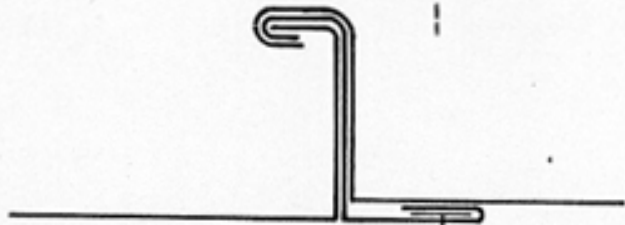
Metal Roof: Standing Seam



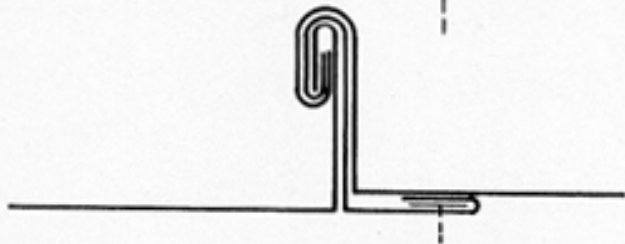
*Step 1: The nailed cleat and pans are aligned.*



*Step 2: The edges of the pans and the cleats are rolled together into a standing seam.*



*Step 3*



*Step 4*

## Metal Roof: Standing Seam

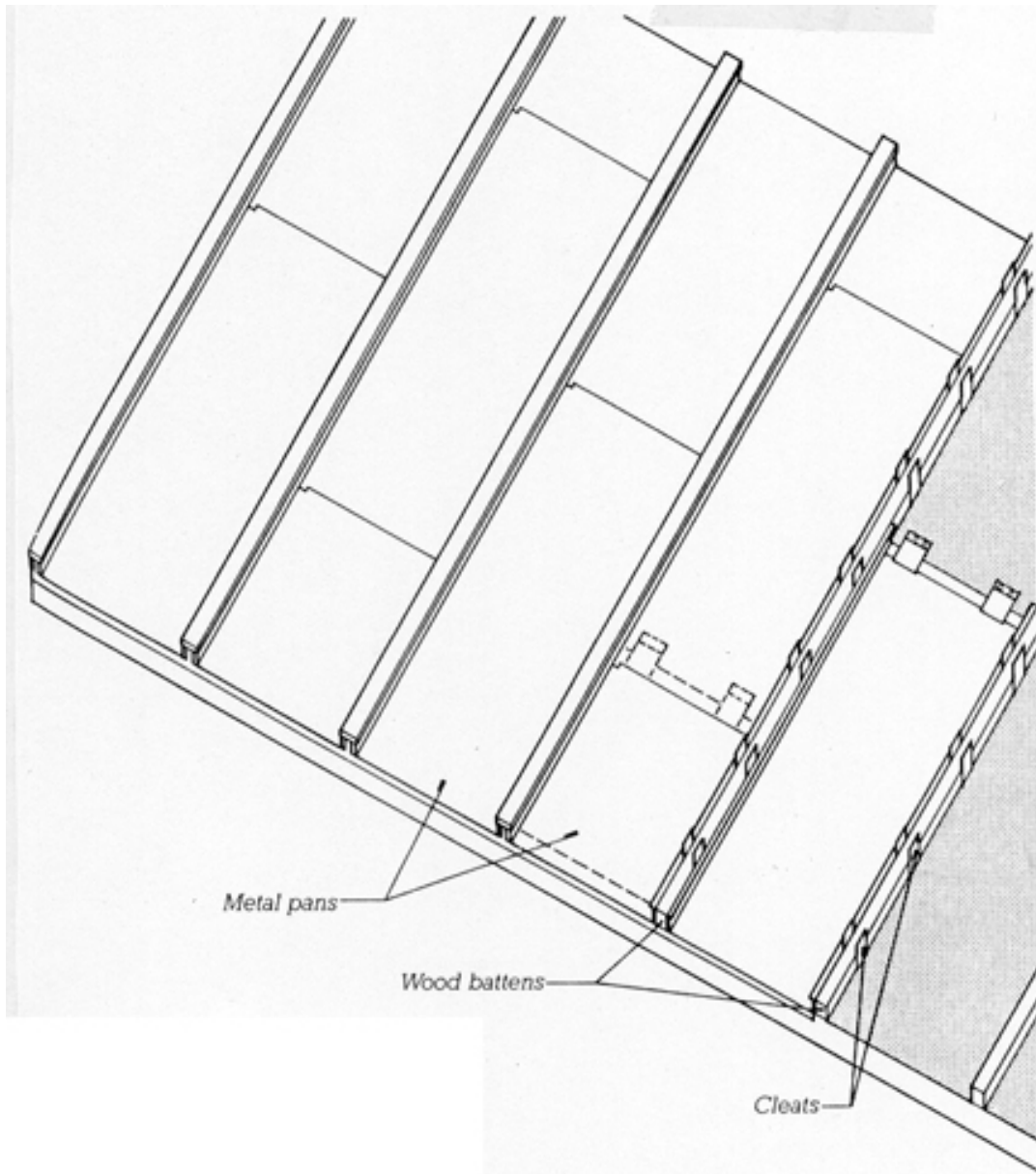


Standing seam metal roof



Contemporary terne-look roof in standing seam



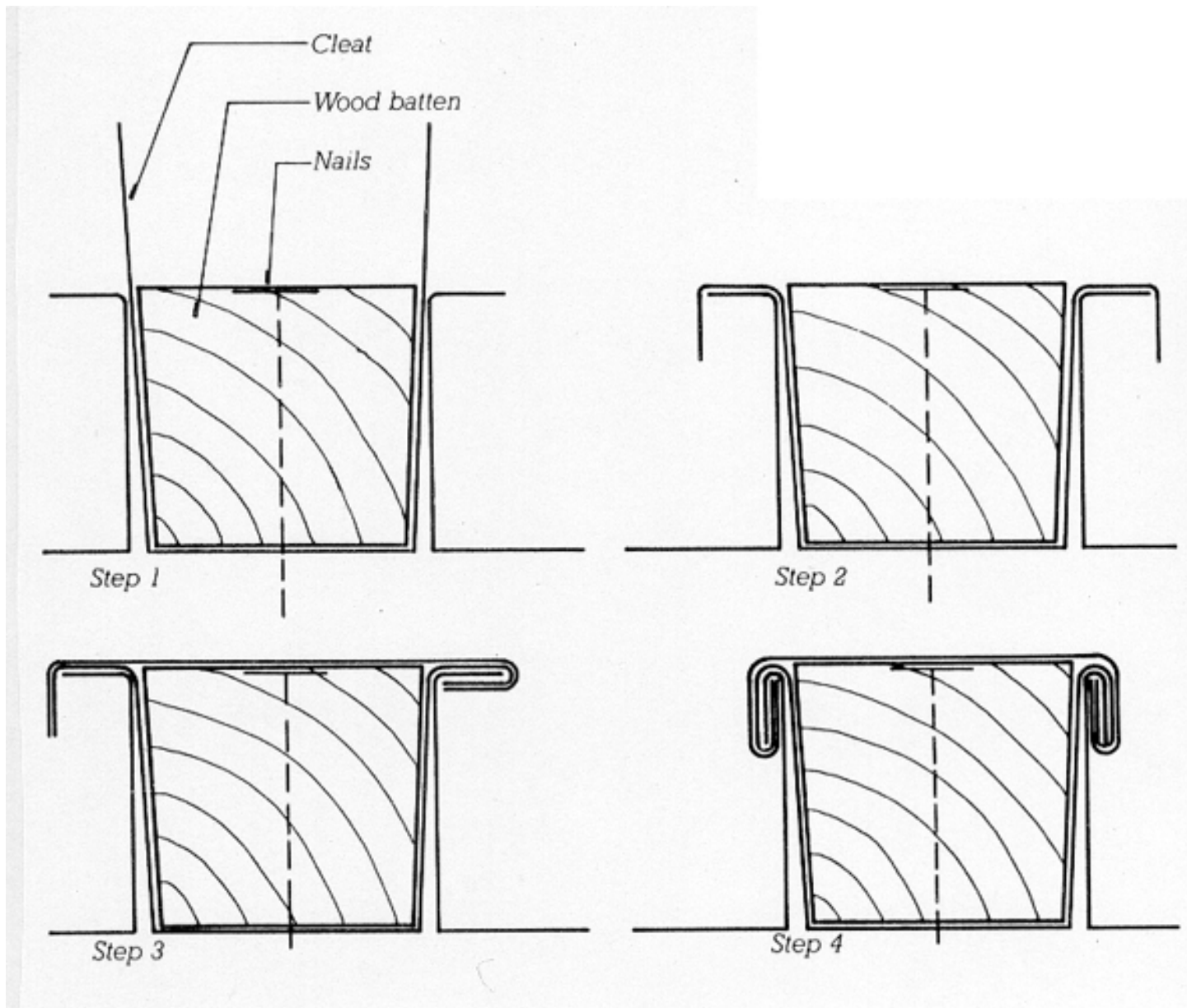


**FIGURE 13.52**

*Installing a batten-seam metal roof. The battens are tapered in cross section to allow for expansion of the roofing metal.*

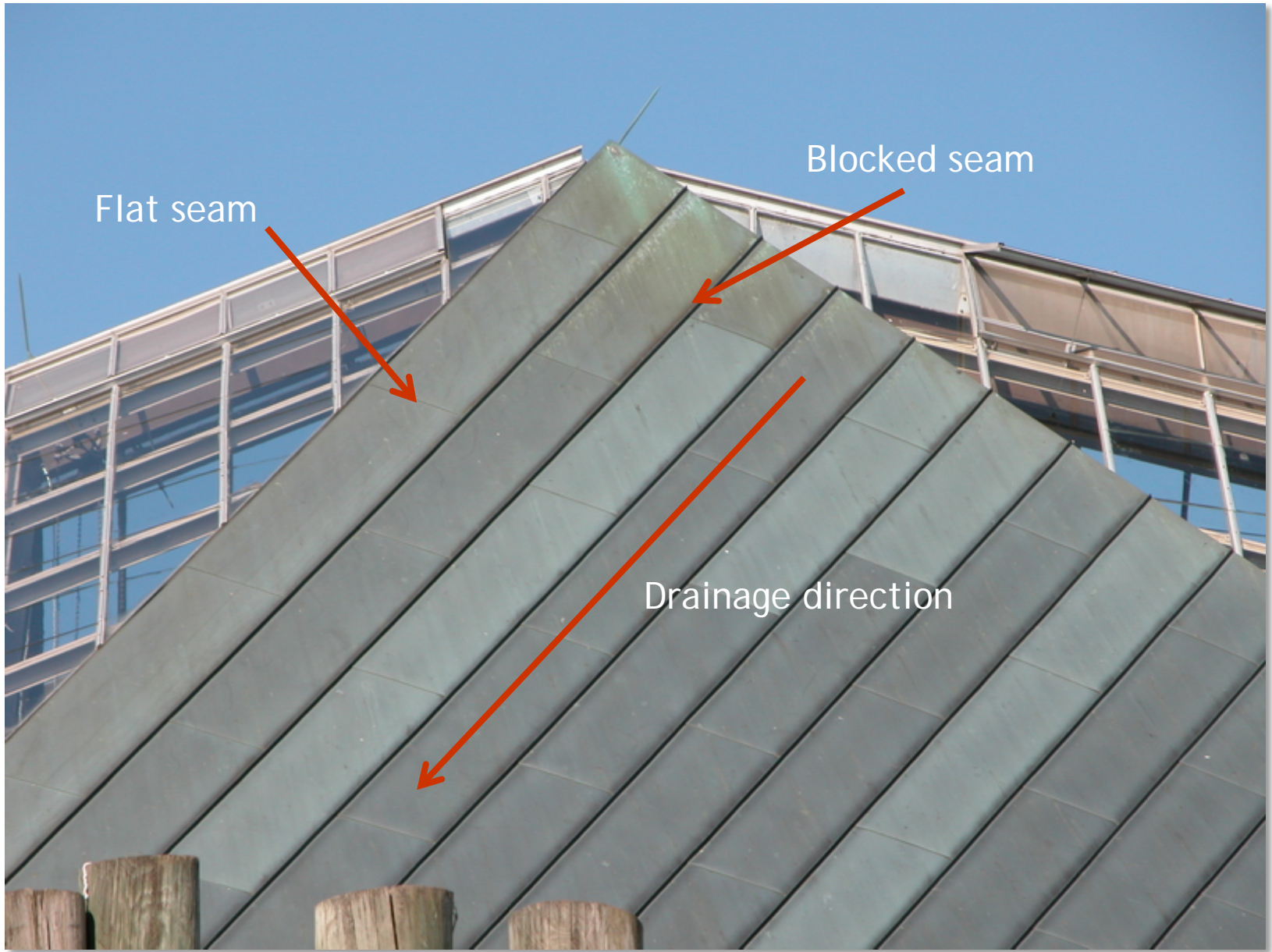
Aluminum
Zinc and galvanized steel
Chromium
Steel
Stainless steel
Cadmium
Nickel
Tin
Lead
Brass
Bronze
Copper

Metal Roof: Blocked Seam



Metal Roof: Block Seam





Toronto Zoo



This is a metal roof with a snow dam at the edge. This is required to stop snow from sliding off the roof and on to the people below.



Snow guards at the edge of roofs



LOADING AREA

LOADING AREA

TOOL RENTAL CENTRE

PLEASE  
LOAD  
HERE  
←←←

KMK

Propane

EXT

# HOME DEPOT



ONTARIO'S HOME IMPROVEMENT

able

kitchens

Blinds

APPLY



TODAY!



YOU FIND

W

# Flat or Low Slope Roofs:

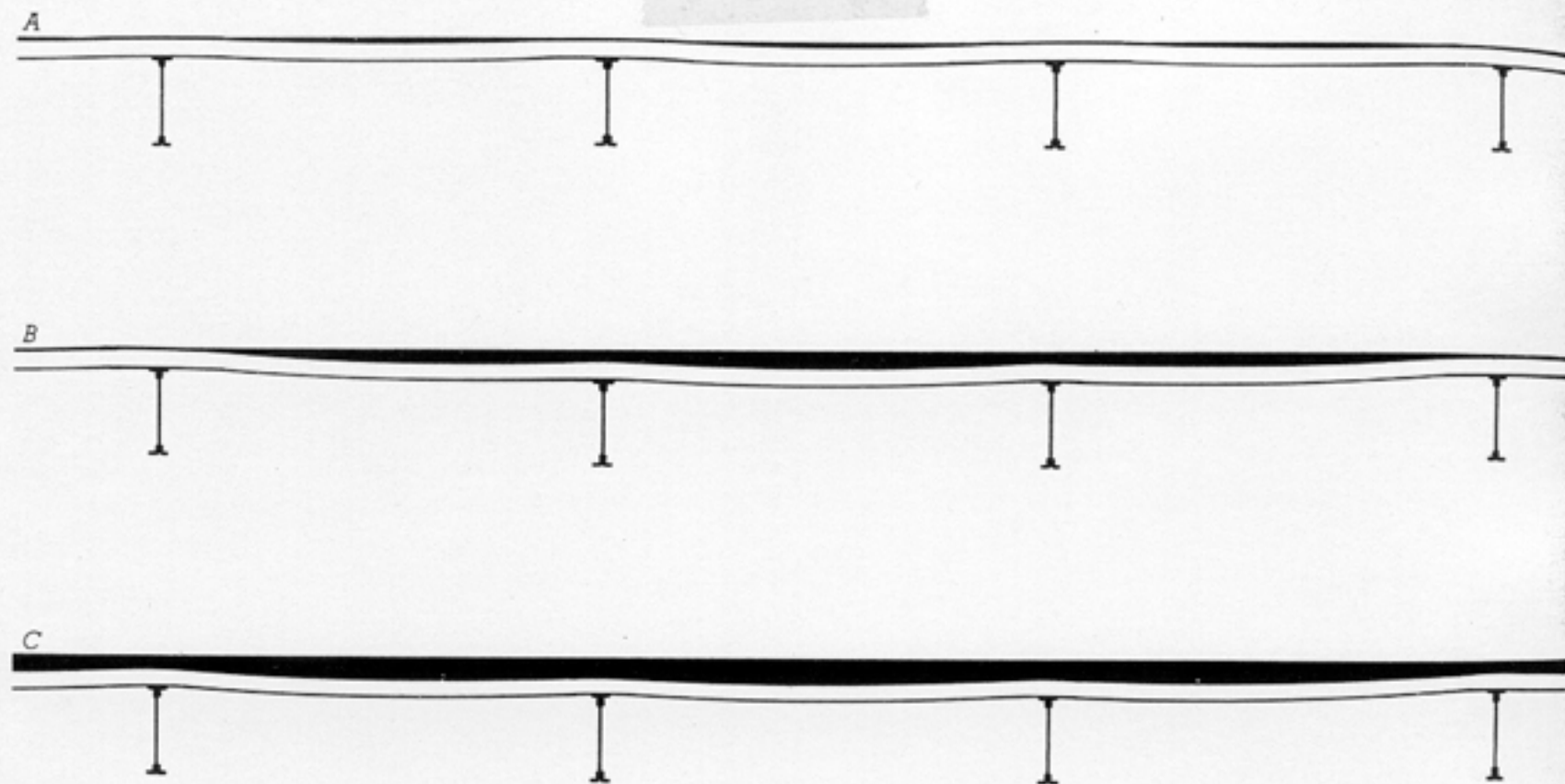
## PRIMARY COMPONENTS:

- structural roof deck
- thermal insulation
- vapour retarder (and air barrier)
- waterproof membrane

# Structural Roof Deck:

- must be designed to *minimize deflection* to reduce ponding and minimize drainage
- either slope the roof deck or taper the insulation to drain roof
- usual materials are:
  - plywood
  - wood decking
  - cast or hollow core concrete
  - steel decking

(choice depends on building type, fire rating and primary structural system)



**FIGURE 13.3**

*A low-slope roof with insufficient pitch to drain is subject to structural failure through progressive collapse, as demonstrated in this sequence of cross sections: (a) Water stands on the roof in puddles, causing slight deflections of the roof deck between supporting beams or joists. (b) If heavy rainfall continues, the puddles grow and join, and the accumulating*

*weight of the water begins to cause serious deflections in the supporting structural elements. The deflections encourage water from a broader area of the roof to run into the puddle. (c) As structural deflections increase, the depth of the puddle increases more and more rapidly, until the overloaded structure collapses.*



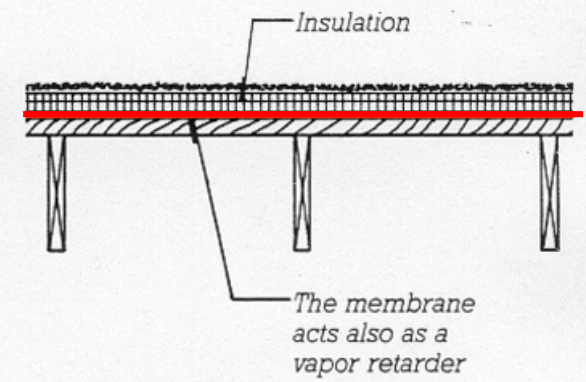
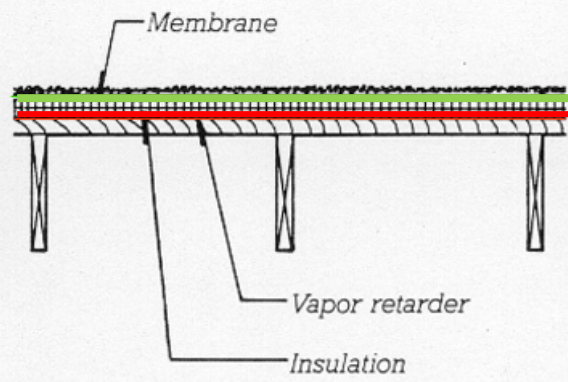
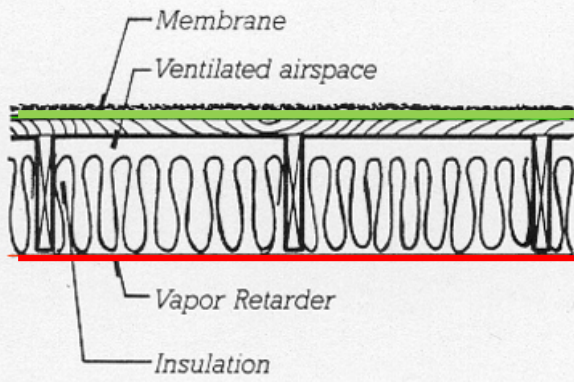


Roof collapse in Poland due to excessive snow loading

# Thermal Insulation:

Can be installed in THREE positions:

- **BELOW** the deck
- **BETWEEN** the deck and the membrane
- **ABOVE** the membrane



**FIGURE 13.4**

*Low-slope roofs with thermal insulation in three different positions, shown here on a wood joisted roof deck. At left, insulation below the*

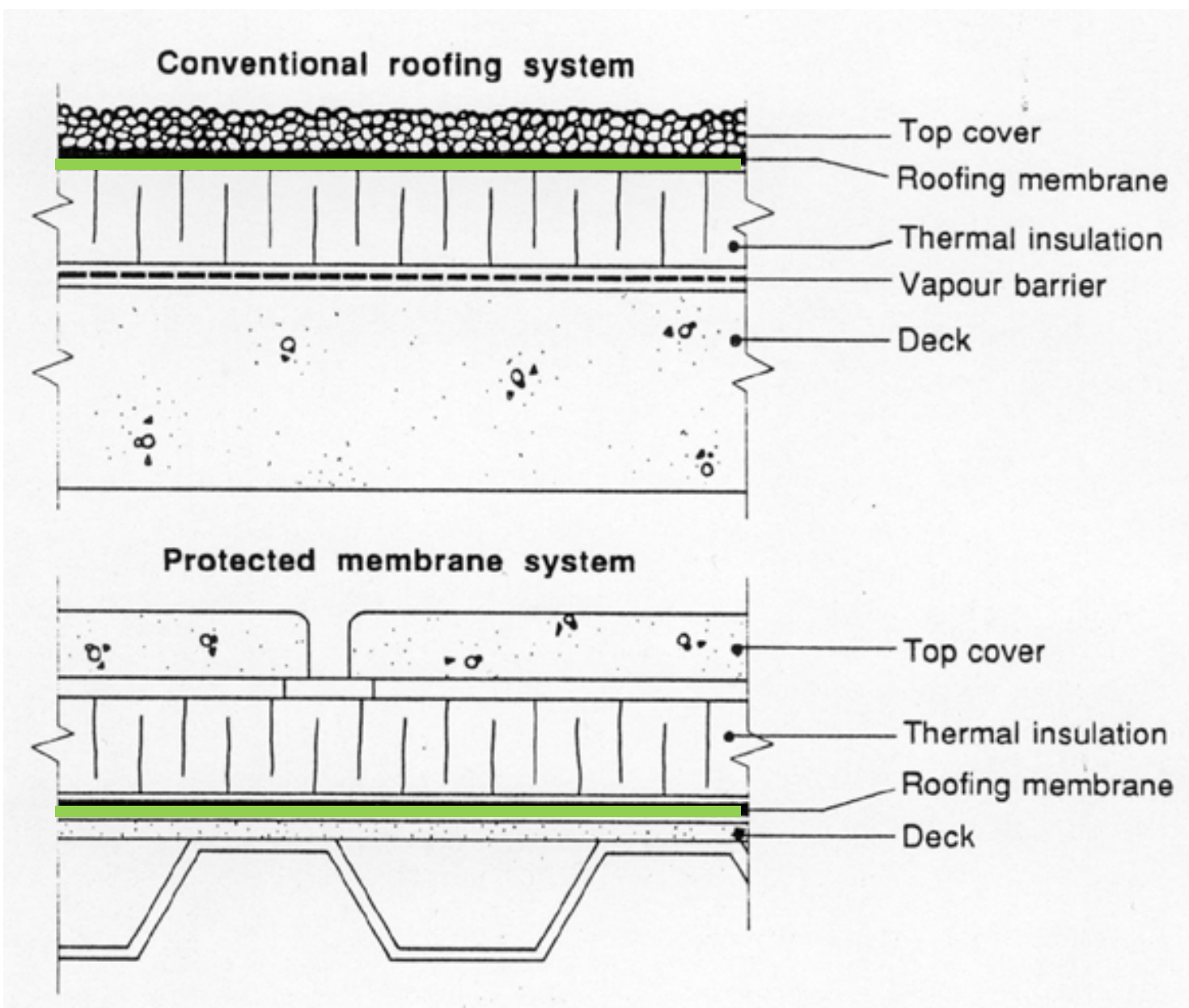
*deck, with a vapor retarder on the warm side of the insulation. In the center, insulation between the deck and the membrane, with a vapor re-*

*tarder on the warm side of the insulation. At right, a protected membrane roof, in which the insulation is above the membrane.*

A vented air space is mandatory when using batt insulation in a flat roof!!

If you use rigid polystyrene insulation (the blue kind) or a foamed in place closed cell type, no air space is necessary as it is waterproof.

## Flat Roof: Insulation and Membrane Position

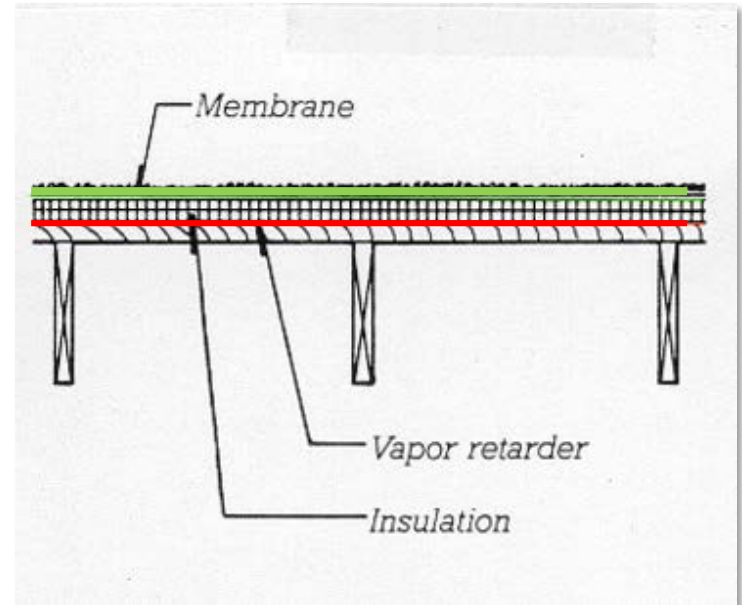


Flat Roof: BUR (traditional) vs. Inverted (newer methodology)

# Insulation BETWEEN Membrane and Deck:

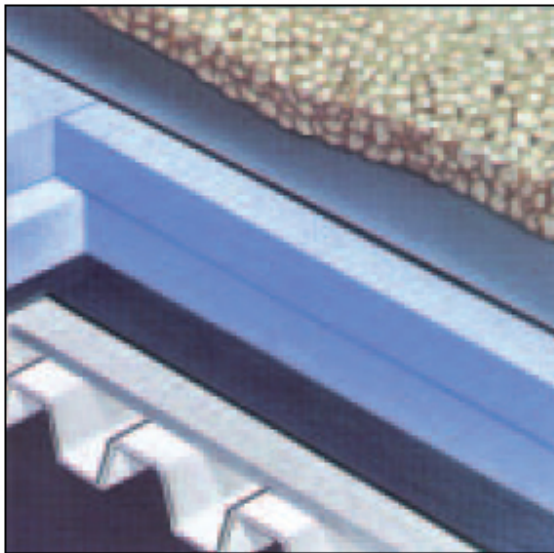
## Traditional location for insulation:

- use low density rigid panels to support the loads on the roof membrane without allowing puncture of membrane
- any water vapour trapped in insulation will cause deck to rot so use topside vents to relieve pressure

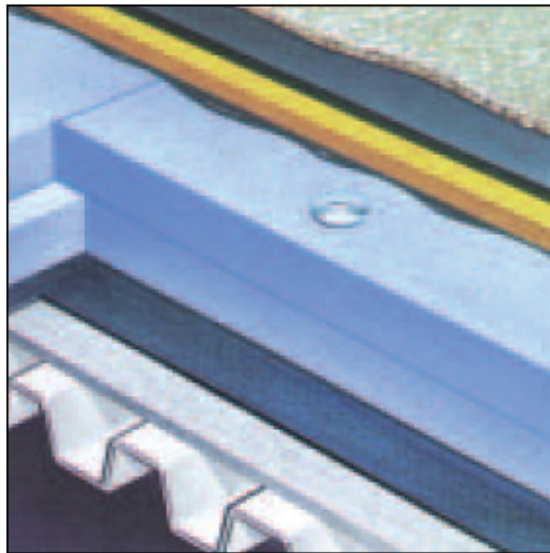


# Insulation BETWEEN Membrane and Deck:

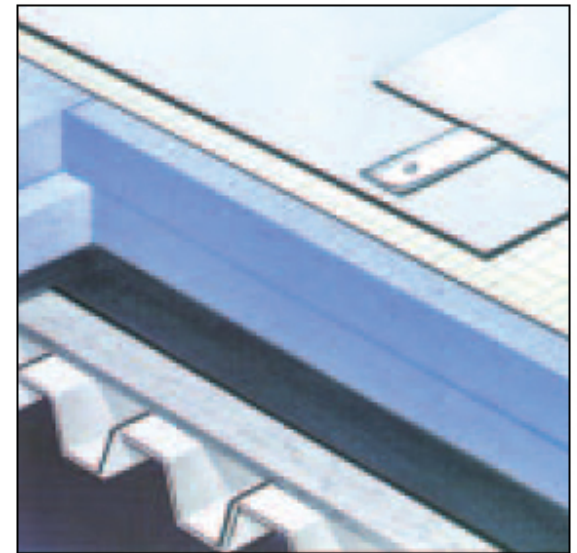
Extruded polystyrene insulation is used on roofs (often blue in colour) as it is not penetrable by water so cannot deteriorate due to water logging. It is sensitive to UV radiation so must be protected.



Loose Laid Ballasted  
Single-Ply Membrane



Fully Adhered  
Single-Ply Membrane



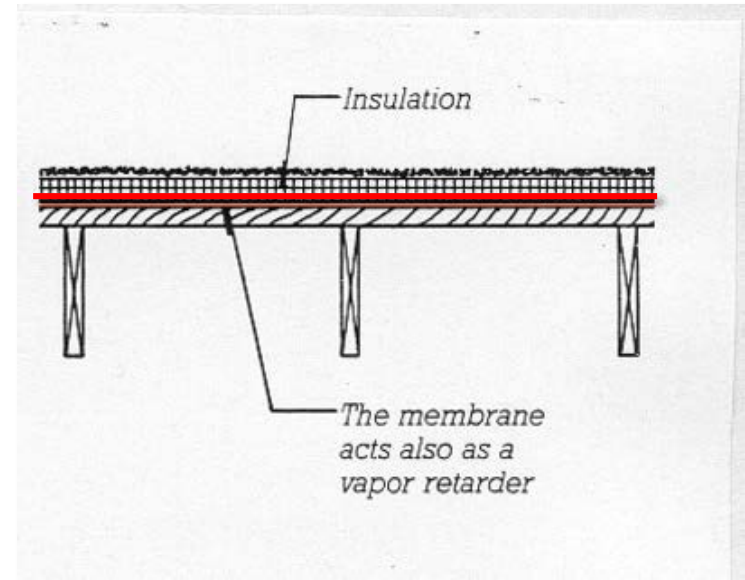
Mechanically Fastened  
Single-Ply Membrane



# Insulation ABOVE the Membrane:

New concept (post 1970) offering major advantages:

- membrane protected from extremes of heat and cold, is on the warm side of the insulation
- membrane protected from UV radiation
- membrane protected from puncture
- insulation must be extruded polystyrene foam board which is water resistant and covered with a filter layer to prevent migration of ballast





# Vapour Retarders for Low Slope Roofs:

- membrane in a protected membrane roof is also the vapour/air barrier
- other types of low slope roofs use two layers of asphalt saturated roofing felt bonded together and to the roof with hot asphalt
- polyethylene film not used as it melts
- situated on the warm side of the insulation



Very likely most of these flat roofs use traditional roofing methods.

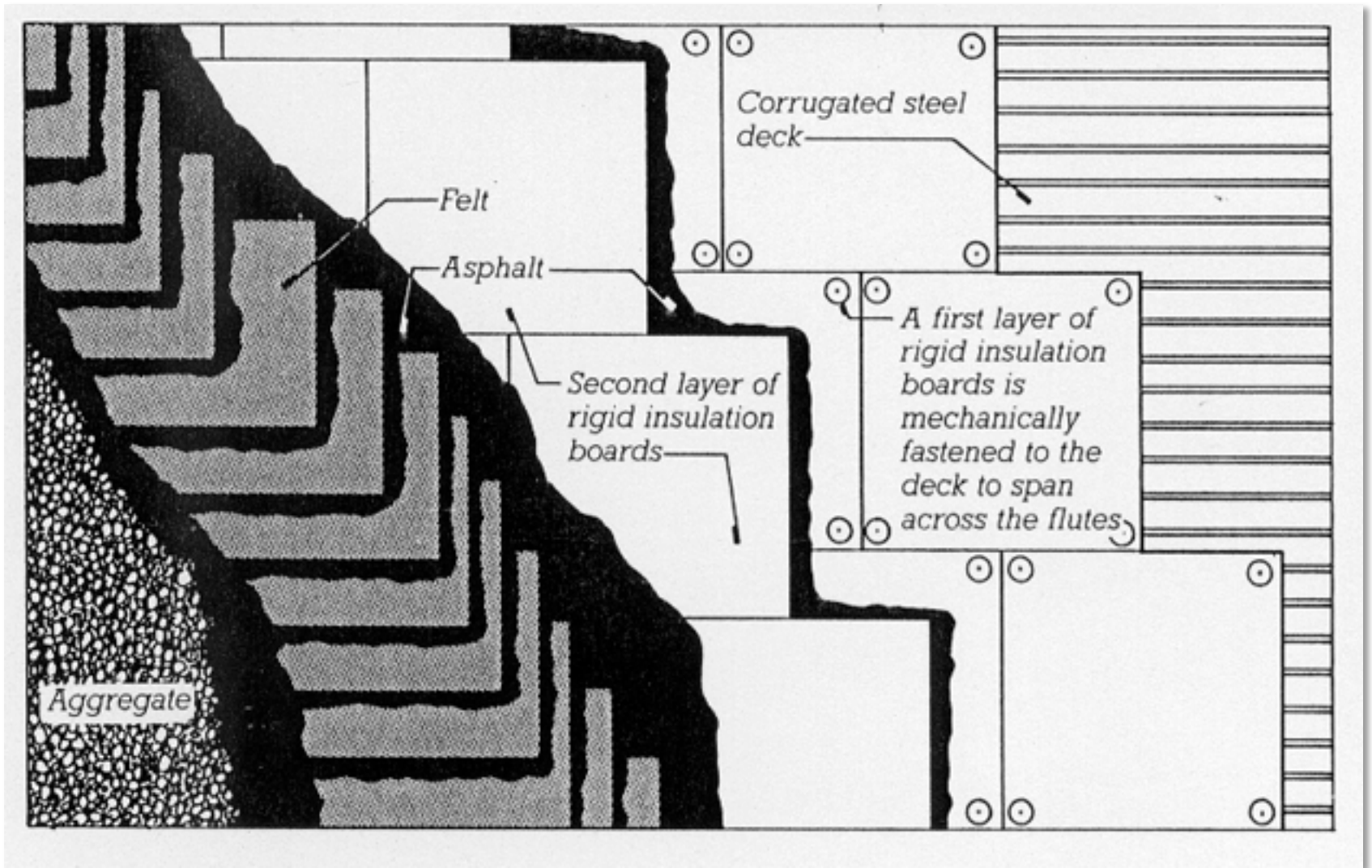
# ROOFING MEMBRANES:

## THREE PRIMARY TYPES:

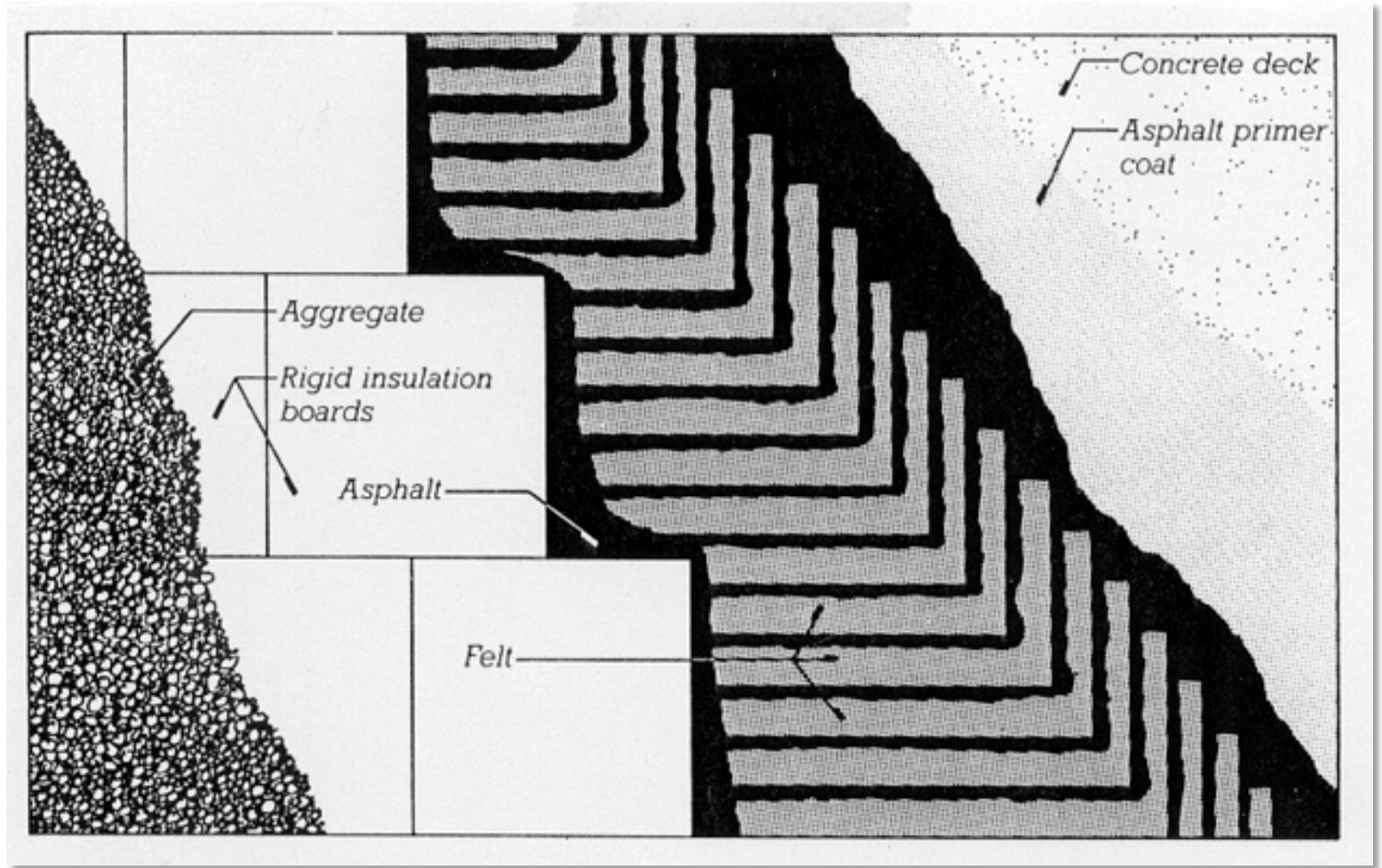
- conventional (bituminous built up roofing or BUR)
- prefabricated sheets (single ply)
- cast in situ

# Conventional: The Built Up Roof (BUR)

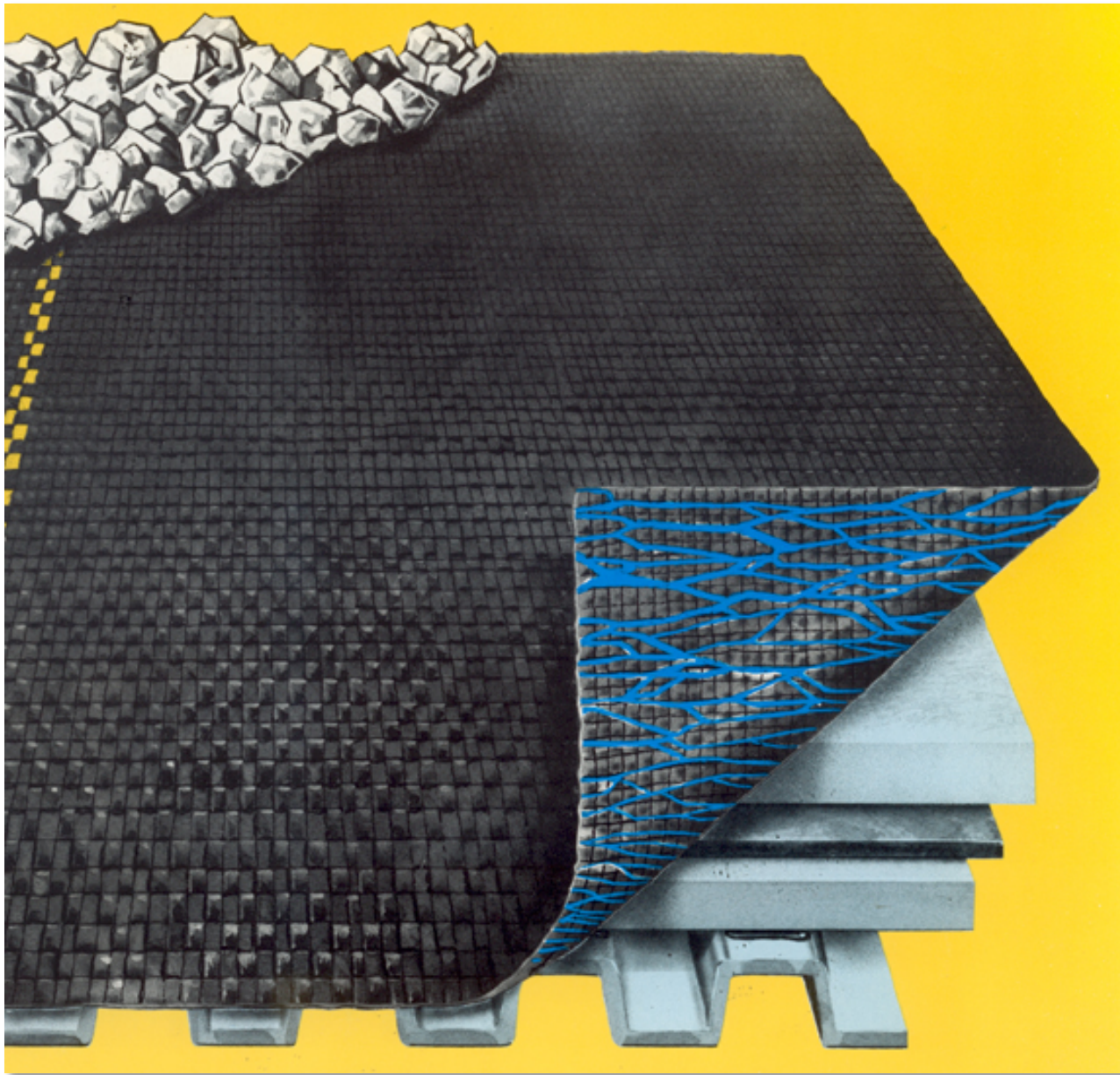
- constructed of 3 to 5 layers of bitumen impregnated felts, layered on the roof deck with heated asphalt
- may be located either over or under the rigid insulation
- top layer of gravel ballast to protect asphaltic materials or insulation from UV rays, and to weight roofing materials against wind uplift forces



BUR on steel decking: insulation below the membrane



BUR on concrete roof deck: insulation above the membrane



Flat Roof: fibre matt used to keep ballast away from insulation

# Built up Roof (BUR)







Built up Roof (BUR)



BUR being  
installed  
over rigid  
polystyrene  
insulation  
(right)



# Prefabricated Sheets: Single Ply

## THERMOPLASTIC SHEETS:

- PVC and blends
- EP (ethylene interpolymers)
- CPA (copolymer alloys)

## ELASTOMERIC (SYNTHETIC) RUBBER SHEETS:

- vulcanized, EPDM or neoprene
- non vulcanized

## MODIFIED bituminous SHEETS:

- polymer modifiers

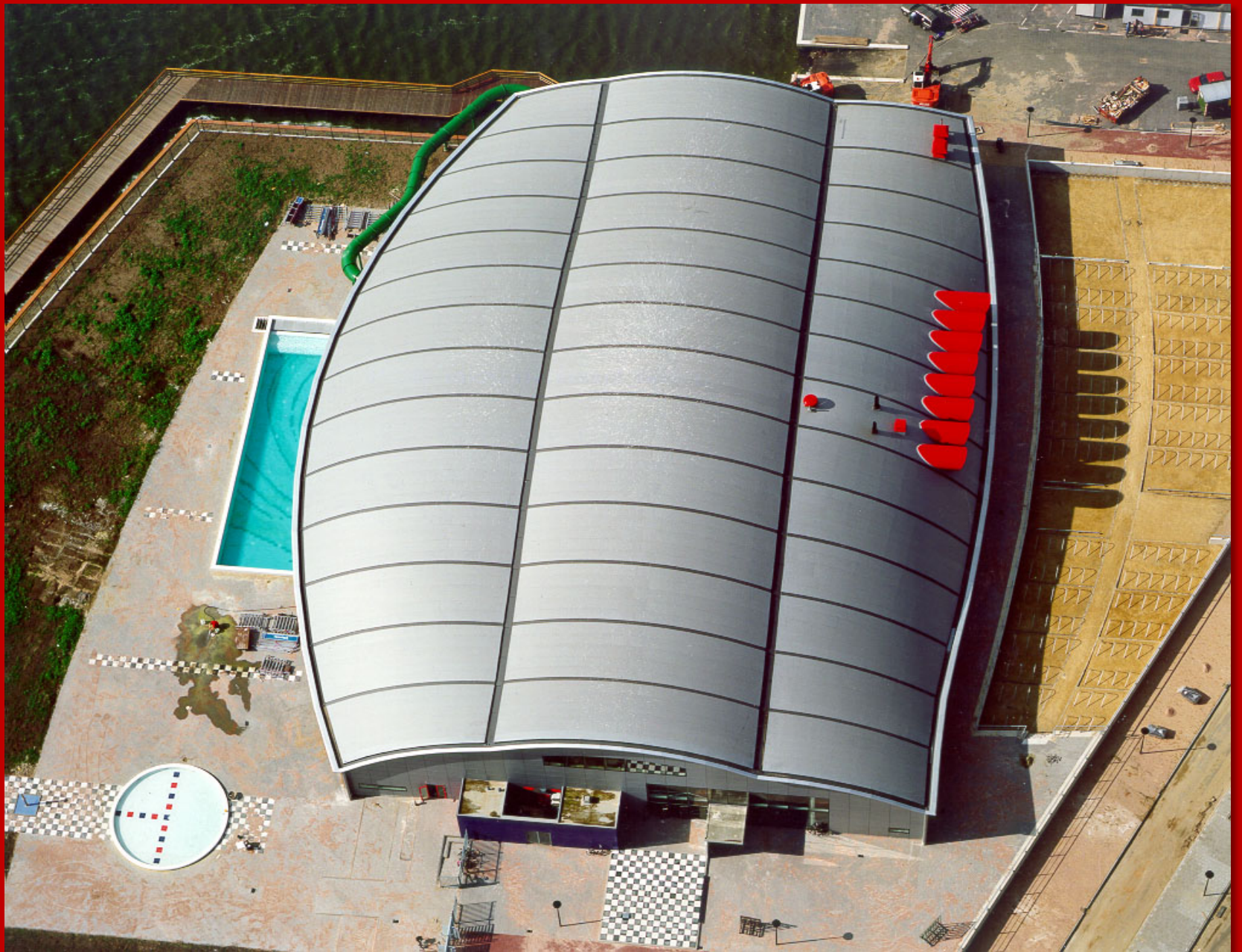
# PREFABRICATED SHEETS: Installation and Attachment

- require less on site labour
- less prone to cracking
- affixed to roof by:
  - adhesives
  - the weight of ballast
  - fasteners concealed in seams between the sheets
  - with ingenious mechanical fasteners that do not penetrate the membrane (if it is flexible enough...)

# THERMOPLASTIC SHEETS:

## PVC:

- commonly known as vinyl
- seams are sealed either by solvent welding or hot air welding
- may be laid loose, mechanically attached, adhered or used as a protected membrane





PVC Roof at Pearson International Airport

# ELASTOMERIC (SYNTHETIC) RUBBER SHEETS: Neoprene

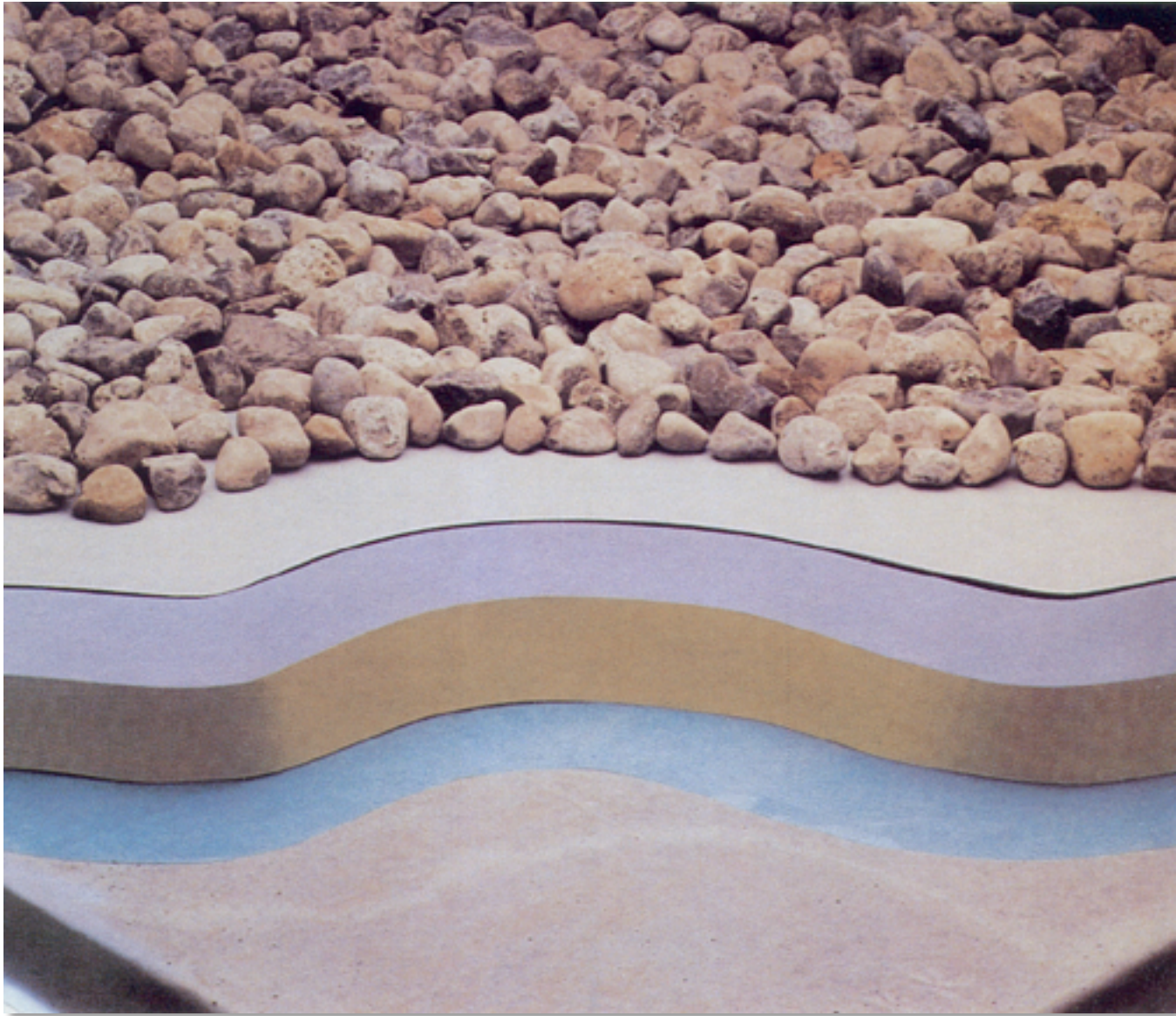
- high performance synthetic rubber compound
- applied in sheets and joined with an adhesive
- vulnerable to UV rays so coated with a protective layer
- may be adhered, mechanically fastened or laid loose and ballasted
- can be used in a protected membrane roof



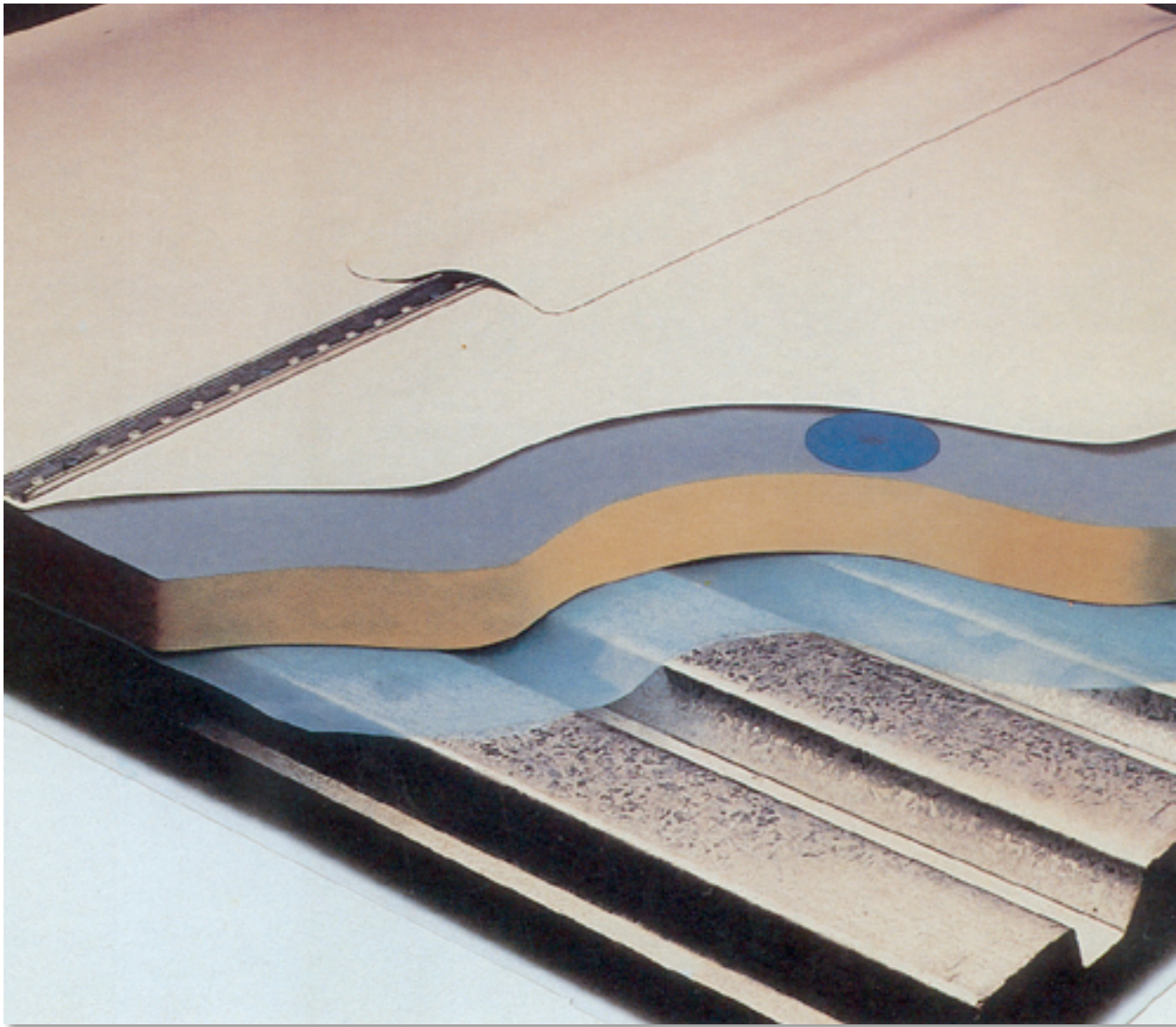
# ELASTOMERIC (SYNTHETIC) RUBBER SHEETS: EPDM (ethylene propylene diene monomer):

- the most widely used material for single ply roofs
- low in cost
- synthetic rubber made in large sheets
- joined with adhesive, laid loose, adhered, mechanically fastened or used in a protected membrane roof

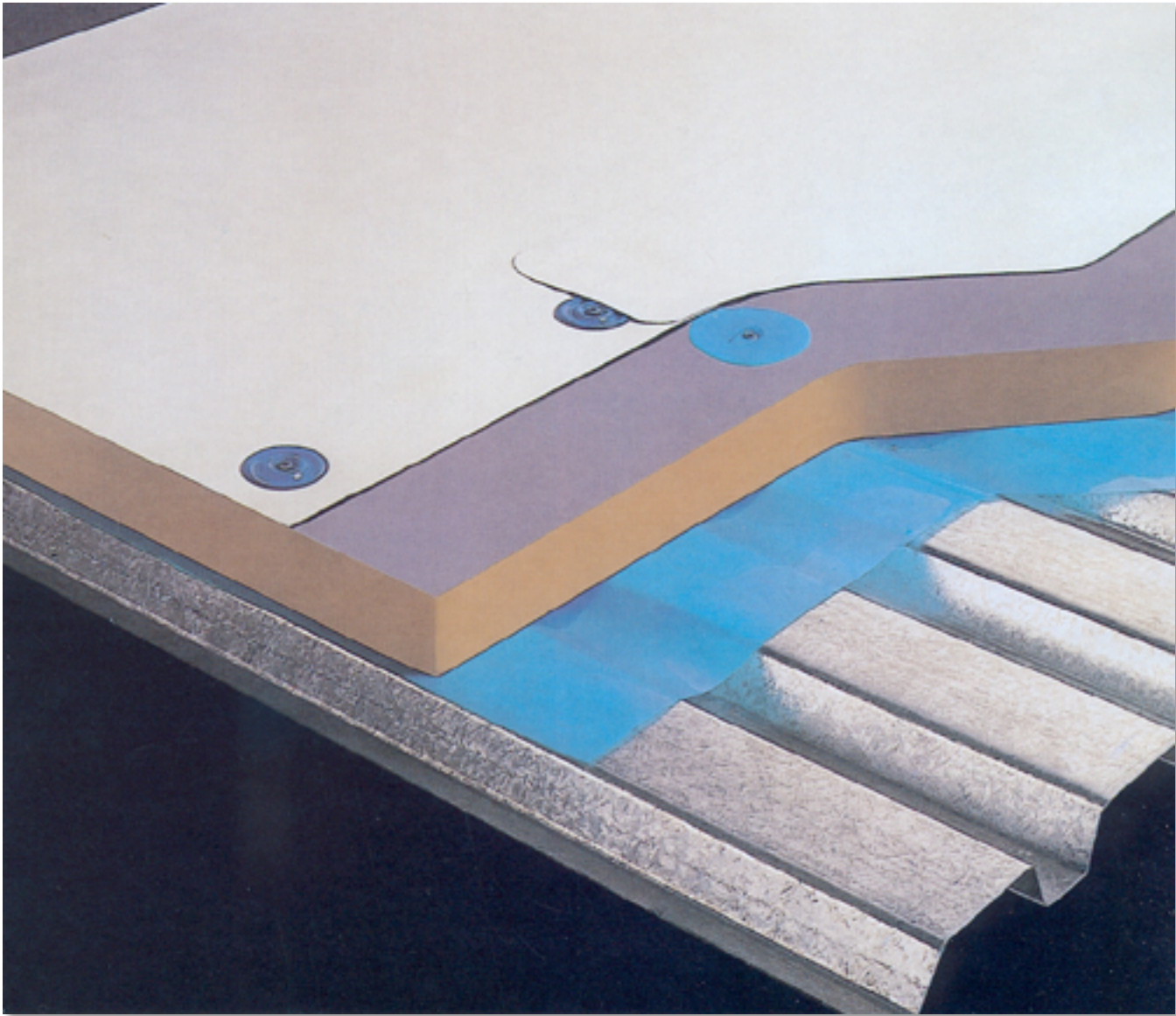




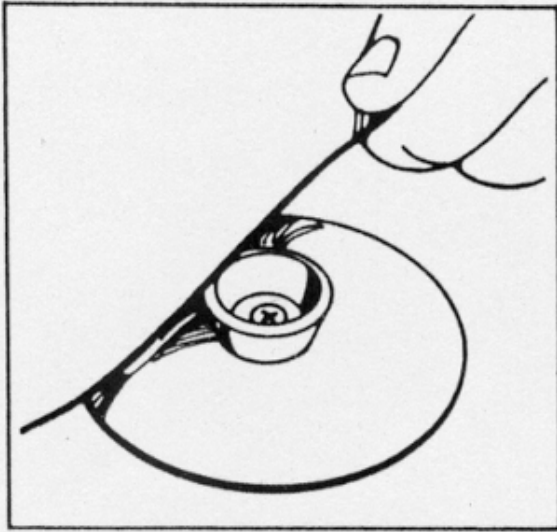
Loose laid, ballasted, membrane



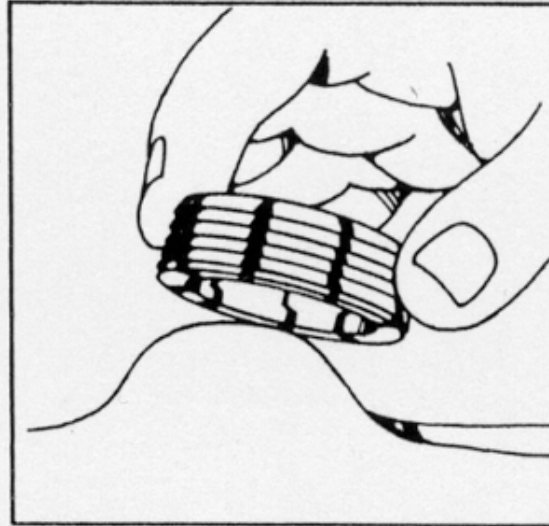
Mechanically fastened membrane: bar type



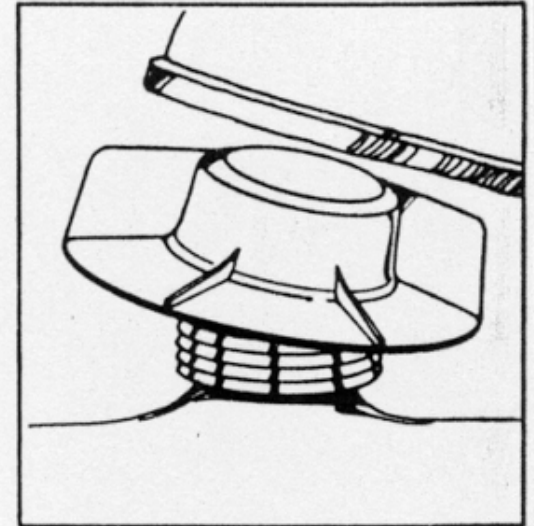
Mechanically fastened with disc fasteners



**1.** Roll membrane over knobbed base plate

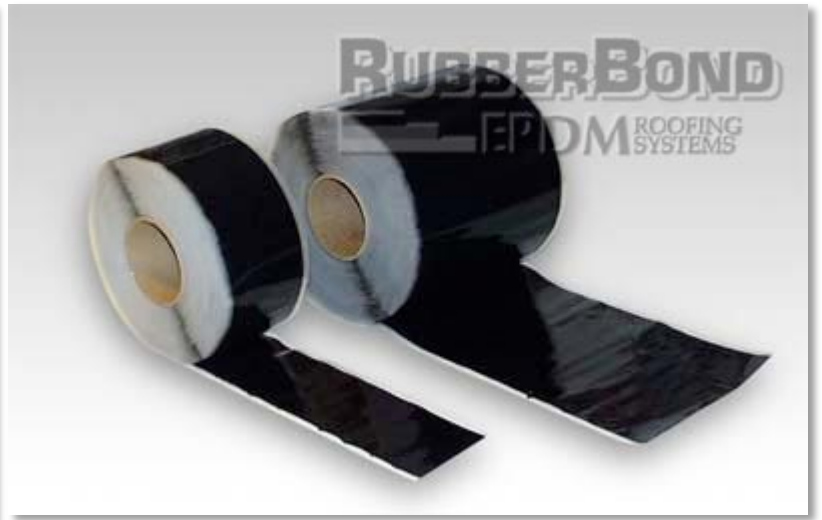
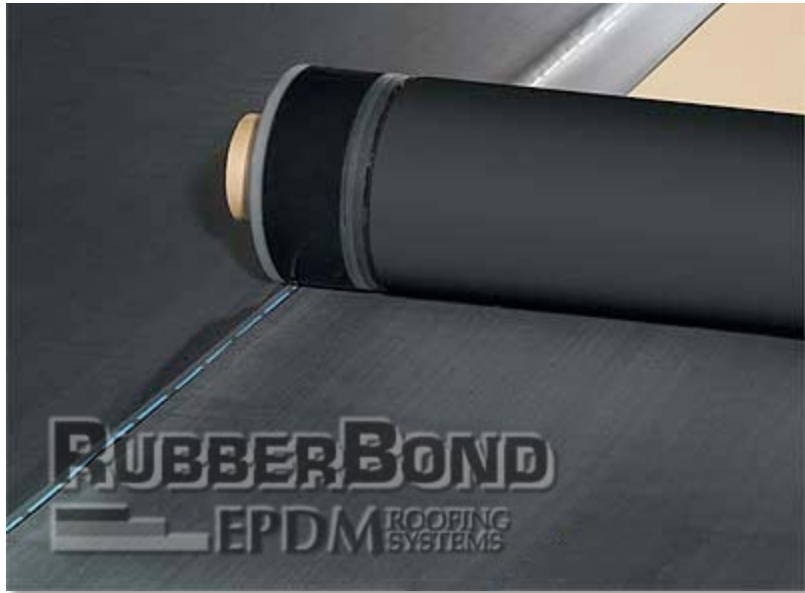


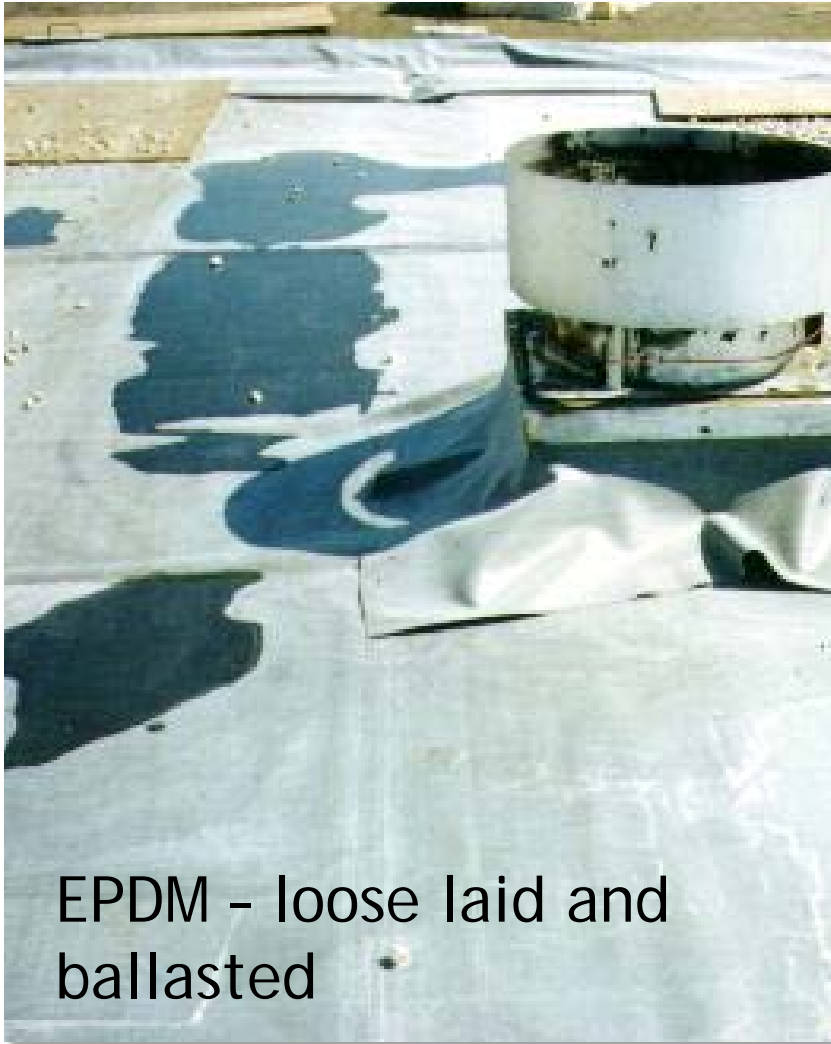
**2.** Roll and snap on white retainer clip



**3.** Snap and screw on threaded black cap

## Disc fastener detail





EPDM - loose laid and ballasted



EPDM flashing



Mechanical fastening strips and an EPDM roof





# Polymer Modified Bitumens:

- sheets of bituminous material to which polymeric compounds have been added to increase cohesion, toughness and resistance to flow
- reinforced with fibrous mats
- some self adhere, or loose laid or laid in hot asphalt
- seams sealed by torching or hot asphaltic adhesive





Rolls of  
polymer  
modified  
bituminous  
roofing  
sheets



OCAD modified bitumenous membrane roofing ready for installation





This is the roofing membrane being installed on the top of the new OCAD addition.



This is a multi-ply installation. The black being the base layer and the grey the more durable top layer. The insulation is beneath the black layer.



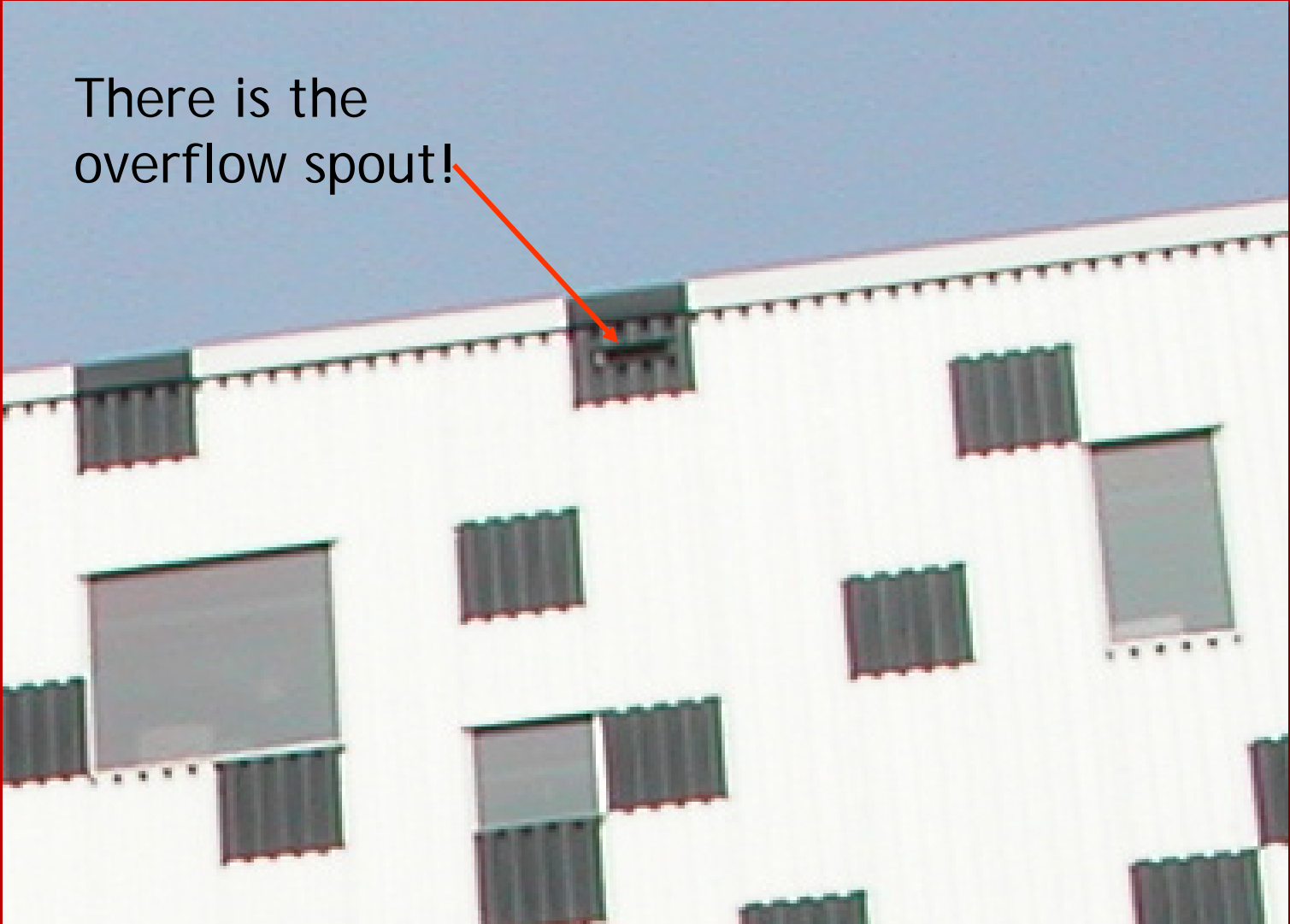


Detail at parapet. Note water overflow opening.

Can you spot the overflow opening??



There is the  
overflow spout!





# Cast in Situ Membranes:

HOT APPLIED RUBBERIZED ASPHALT

COLD APPLIED LIQUID COMPOUNDS

- various polymeric and bituminous materials

POLYURETHANE FOAM ROOF WITH  
PROTECTIVE COATING

# Fluid Applied Membranes:

- used primarily for domes, vaults and complex shapes
- applied with a roller or spray gun in several coats and cure to form a rubbery membrane
- used as a spray on waterproofing layer over sprayed on polyurethane foam insulation



Spray applied elastomeric membrane roofing



Spray applied elastomeric membrane roofing



# REQUIREMENTS OF ROOFING MEMBRANES:

- tensile strength
- elongation
- crack bridging
- fatigue resistance
- thermal shock
- tear resistance
- abrasion resistance
- lap joint integrity
- static puncture
- impact resistance
- low temp. flexibility
- weatherability
- heat aging
- dimensional stability
- granule embedment

# Requirements continued:

- membrane attachment
- flashing attachment
- materials compatibility
- wind uplift resistance

These requirements apply to conditions during manufacture, during installation and in the field in service.

# Details

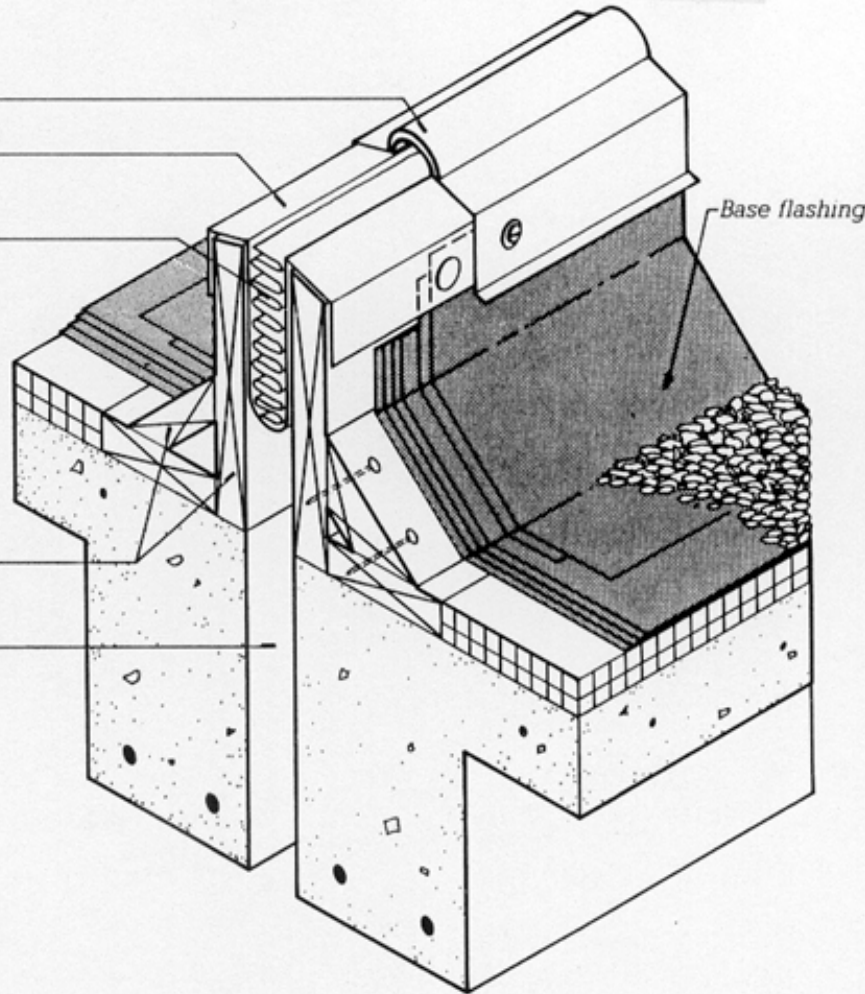
Flexible,  
waterproof  
expansion joint  
cover

Vapor retarder

Compressible  
insulation

Wood curb and  
cant

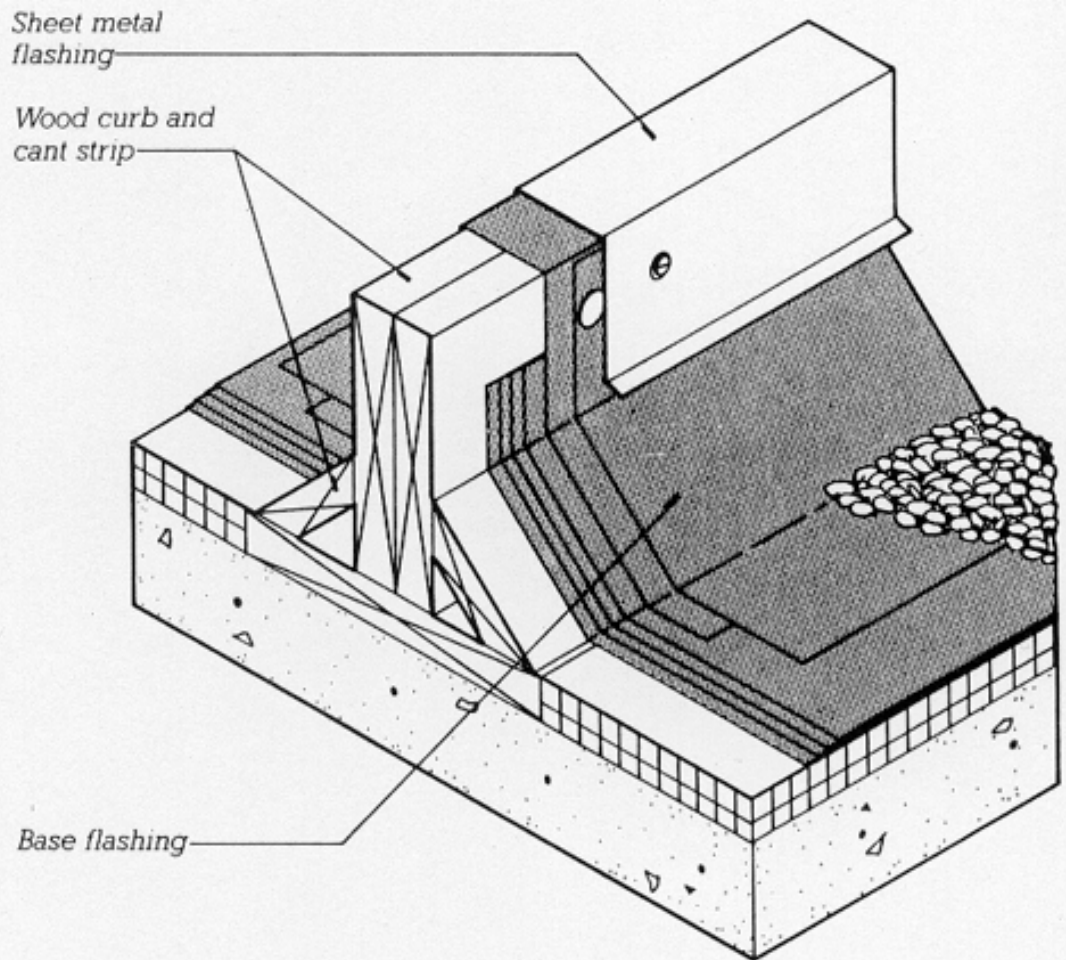
Division in  
building structure



**FIGURE 13.27**

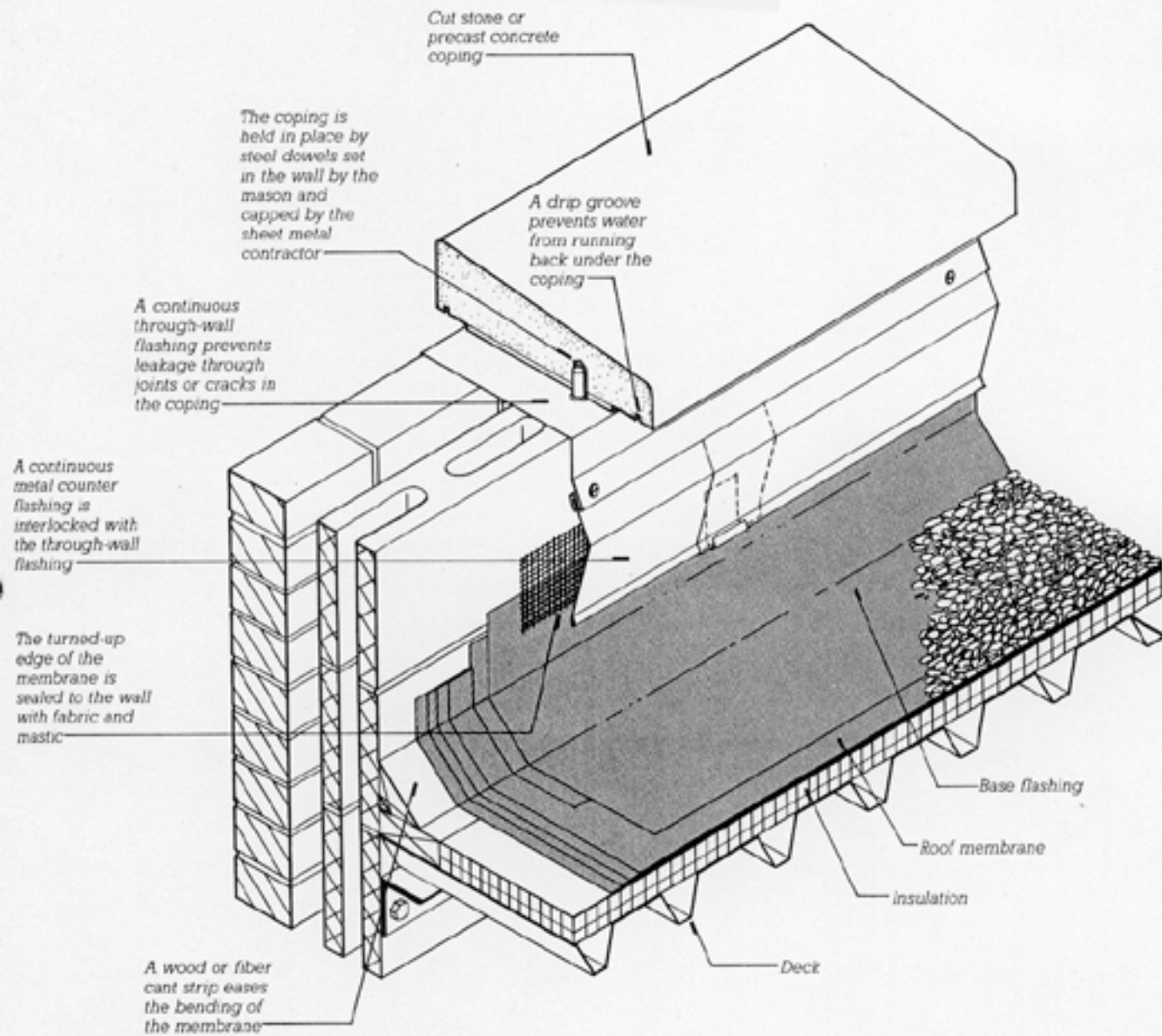
*A building separation joint in a low-slope roof. Large differential movements between the adjoining parts of the structure can be tolerated with this type of joint because of the ability of the flexible joint cover to adjust to movement without tearing. A two-ply base flashing seals the edge of the membrane.*

Flat Roof: expansion joint detail



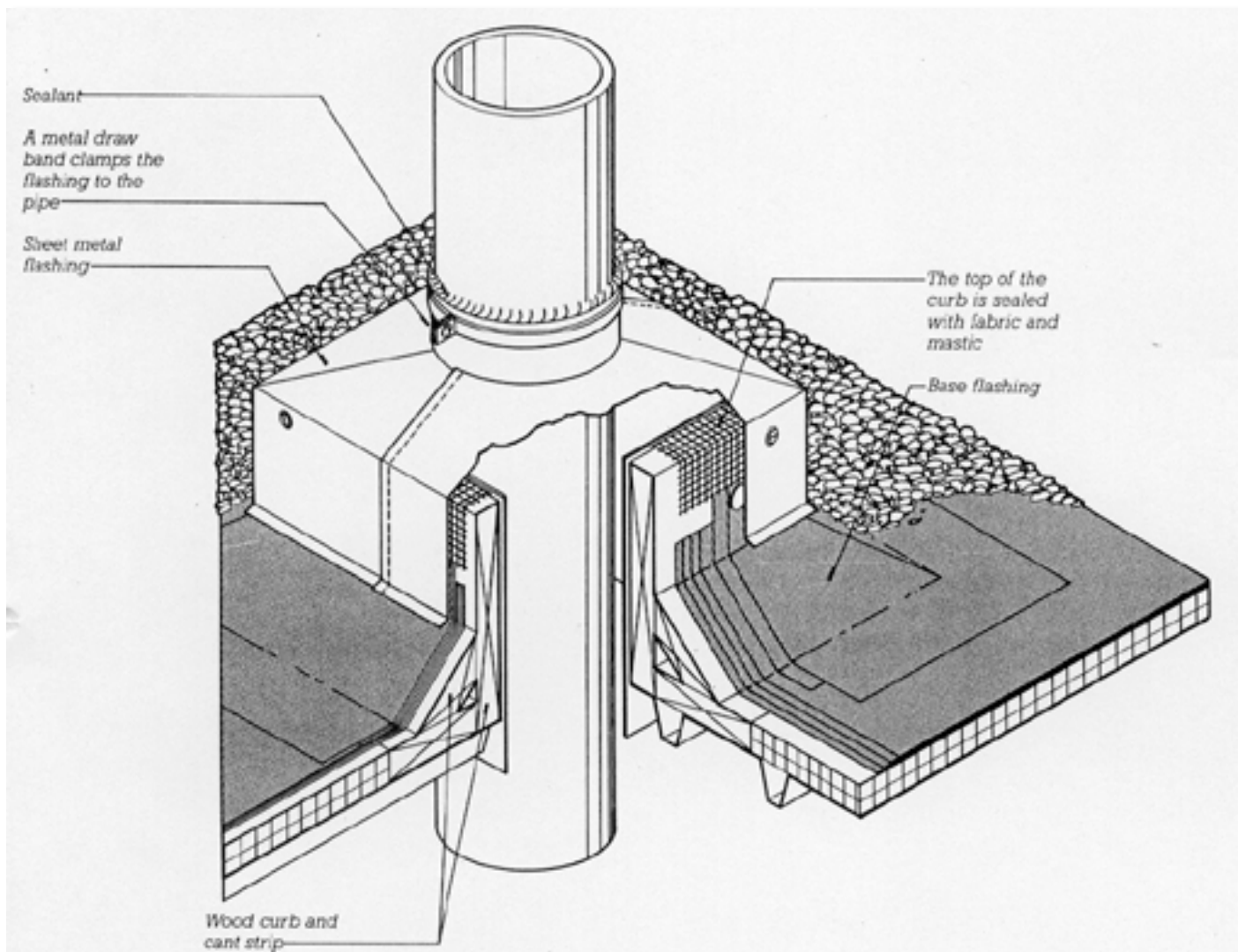
**FIGURE 13.28**  
*An area divider is designed only to allow for some movement in the membrane itself, not the entire structure.*

Flat Roof: area divider



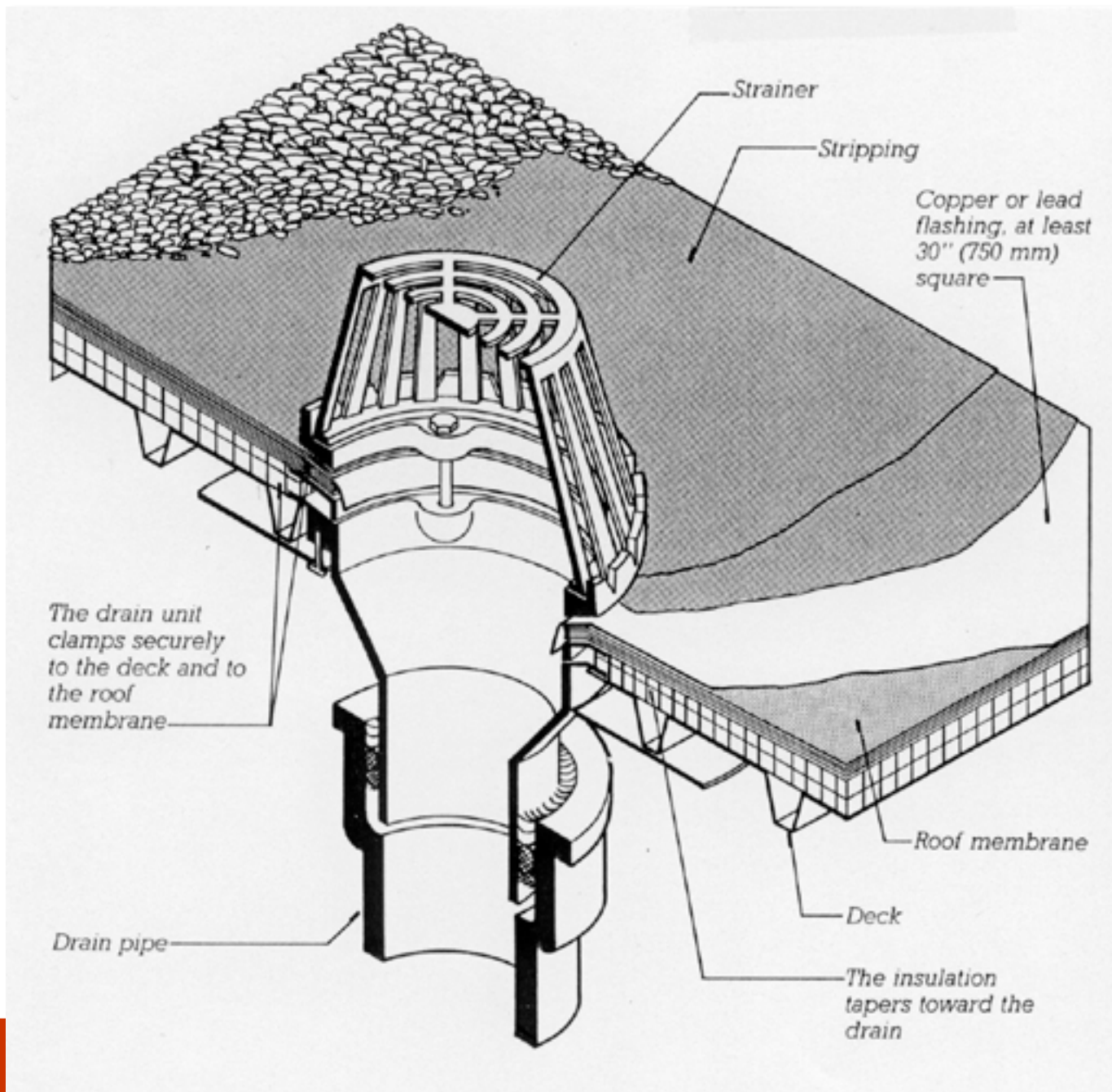
**FIGURE 13.29**

*A conventional parapet design. The coping attachment and flashing are very labor intensive, and therefore costly.*



**FIGURE 13.33**

*A roof penetration for a plumbing vent stack. Notice how this and all the previous edge and penetration details for a flat roof use the curb, cant strip, and stripping to keep standing water away from the edge of the membrane.*



# Green Roofs

- A significant environmental improvement to roofing applications has been the “invention” or “adoption” of green roof practices.
- Green roofs are installed over a modified version of more conventional flat roofs, and are normally comprised of a “system” that is sold by several green roof manufacturers (like Soprema)
- These roofs have been used widely in Europe for many years



## Two main types:

- **intensive** (thicker growth medium required for larger plants)
- **extensive** (thinner, lighter growth medium required for smaller plants) - *this one is more popular*



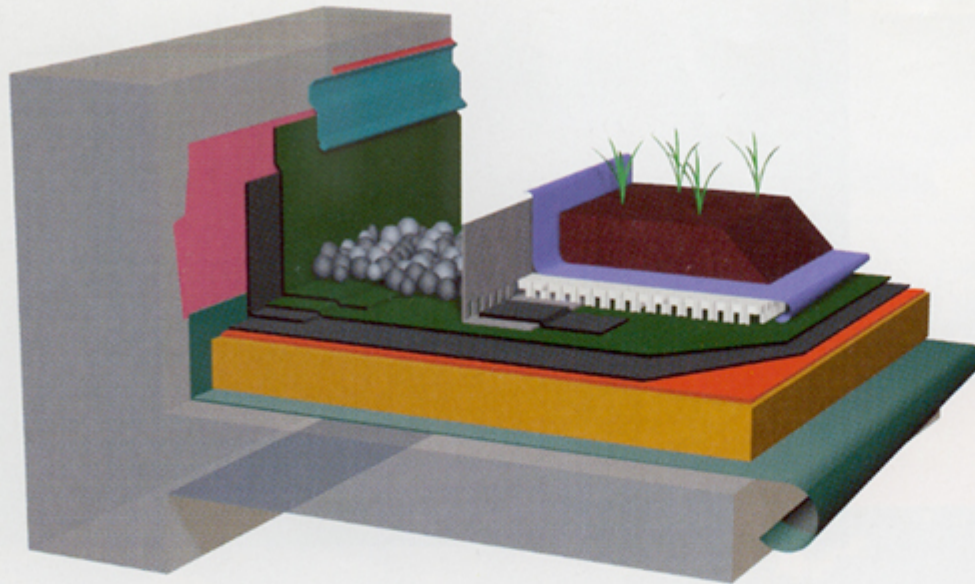
Very old green roof over the Halifax Citadel.



# Sopranature

NATURE RULES THE ROOF!





-  Vegetation
-  Sopraflor Growing Medium
-  Soprafiltre
-  Sopradrain PSE or GEO
-  Curb
-  Ballast
-  Sopralene Flam Jardin Cap Sheet
-  Base Sheet Options:  
Sopralene Flam 180  
or Elastophene Flam  
or Self-adhesive Membrane
-  Elastocol 500 Primer
-  Support Panel for Membrane
-  High Density Thermal Insulation
-  Caulking Mastic
-  Vapour Barrier
-  Metal Flashing
-  Support

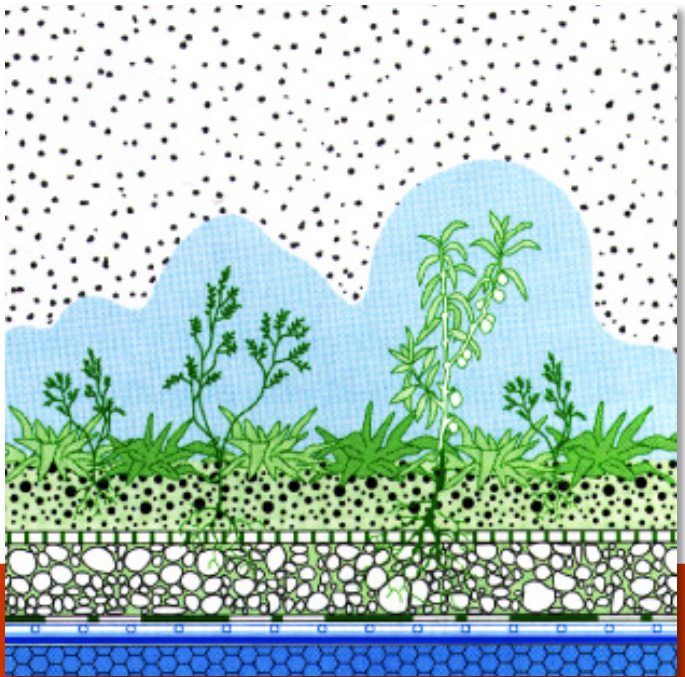
## THE SOPRANATURE SYSTEM

## THE SOPRANATURE SYSTEM

<b>SOPRALENE FLAM JARDIN WATERPROOFING MEMBRANE</b>	The 2-ply SOPRALENE FLAM JARDIN system waterproofs the deck. The membrane contains root repelling agents that prevent root penetration.
<b>DRAINAGE LAYER</b>	Its purpose is to facilitate water flow to the roof drains. It is composed of one of the following materials, depending on roof slope: SOPRADRAIN PSE expanded polystyrene (0-5% slope), or SOPRADRAIN GEO drainage geotextile (>5%).
<b>FILTER</b>	SOPRAFILTER is a non-woven synthetic geotextile that prevents fine particles from clogging the drainage layer.
<b>GROWING MEDIUM</b>	SOPRAFLOR growing medium is designed and manufactured to achieve optimum water retention, permeability, density and resistance to erosion in order to support lush vegetation over the entire roof.
<b>VEGETATION</b>	The vegetation is an integral part of the SOPRANATURE system and has been selected for its ability to adapt to extreme weather conditions. In extensive systems, ground covers are used, that is, annuals, biennials and perennials that regenerate themselves and spread naturally over the growing medium. In semi-intensive systems, perennials, shrubs and grass grow in an irrigated rooftop garden.

## EDGE PROTECTION

Edges and roof structures must be protected by a 500 mm band of gravel or pavers. A prefabricated border of precast concrete, metal or wood is installed to contain the vegetation areas.



Sopravert is Sarnafil's European green roof system. It maintains that the green roof also helps to buffer from the effects of sound as well as weather, and controls/delays runoff from heavy rain.

# Mountain Equipment Coop, Toronto:

- This environmentally conscious retailer has chosen to use green building practices on their buildings.





# Vancouver Public Library:

The green roof on VPL is not accessible to the public (has no guard rails at the edge) and is planted with grasses. The idea being to reduce urban heat island while providing a nice view for taller buildings adjacent



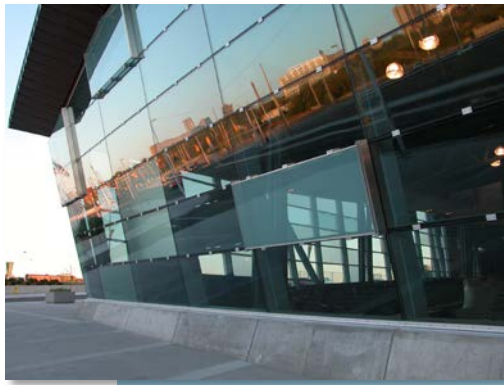
# YMCA Environmental Learning Centre:

- This building illustrates the ability to install a green roof in a sloped situation





Herb garden green roof on Fairmont Hotel in Vancouver



Freshly planted green roof on Canadian War Museum (May 2005)



May 2012



Partial green roof on the Salt Lake City Library by Moshe Safdie



Renzo Piano Science Museum, San Francisco



Operable skylights to vent heat from interior





Drainage paths for excess water



Boston Children's Museum: green roof panels/squares



Caixa Forum, Madrid. 2007. Patrick Blanc



Miami Art Gallery. Herzog & deMeuron.







Branley Museum. Ateliers Jean Nouvel.









Convention Centre. Sydney, Australia





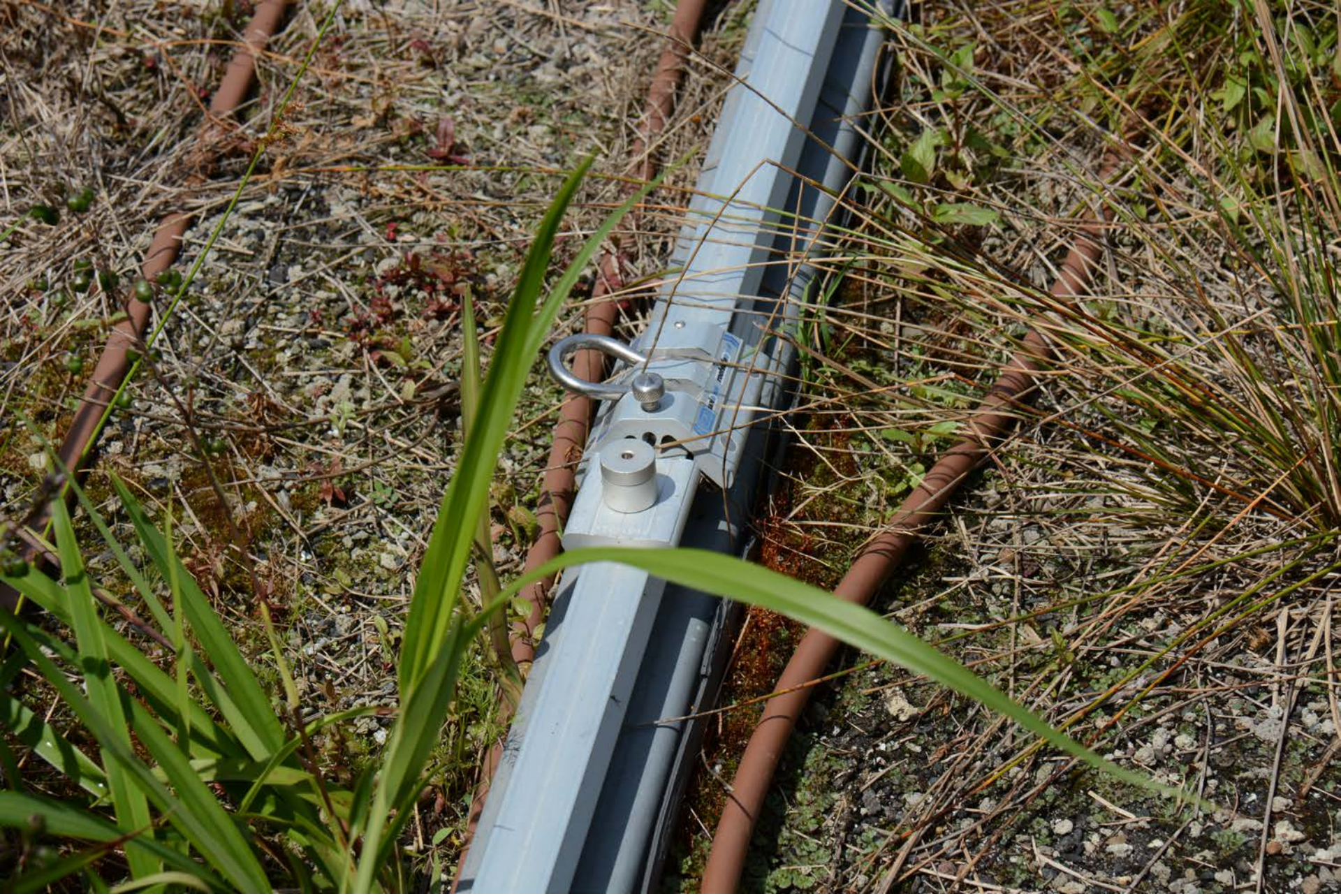








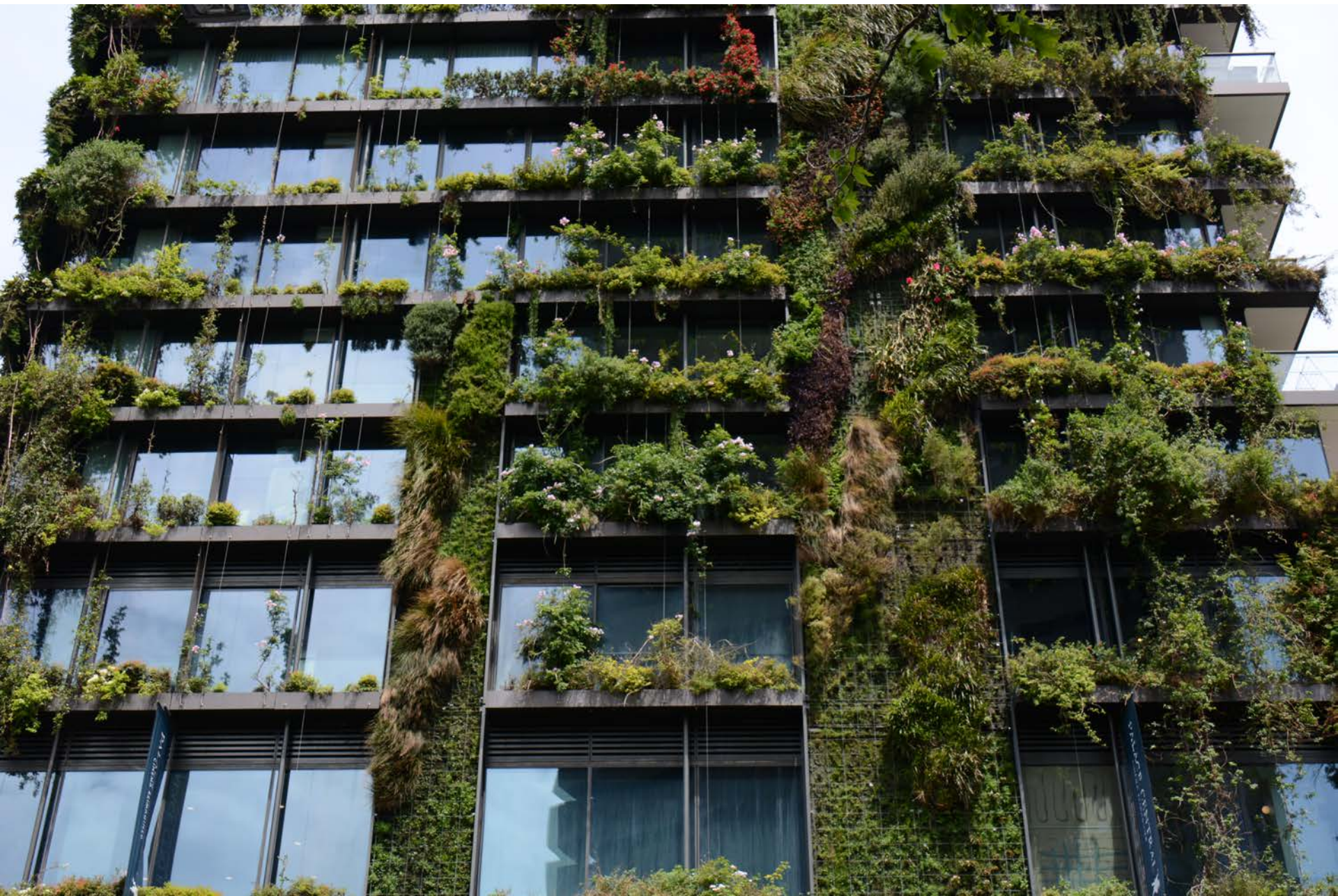






One Central Park, Sydney, Australia, Ateliers Jean Nouvel











Healing Garden, Massachusetts General Hospital, Boston









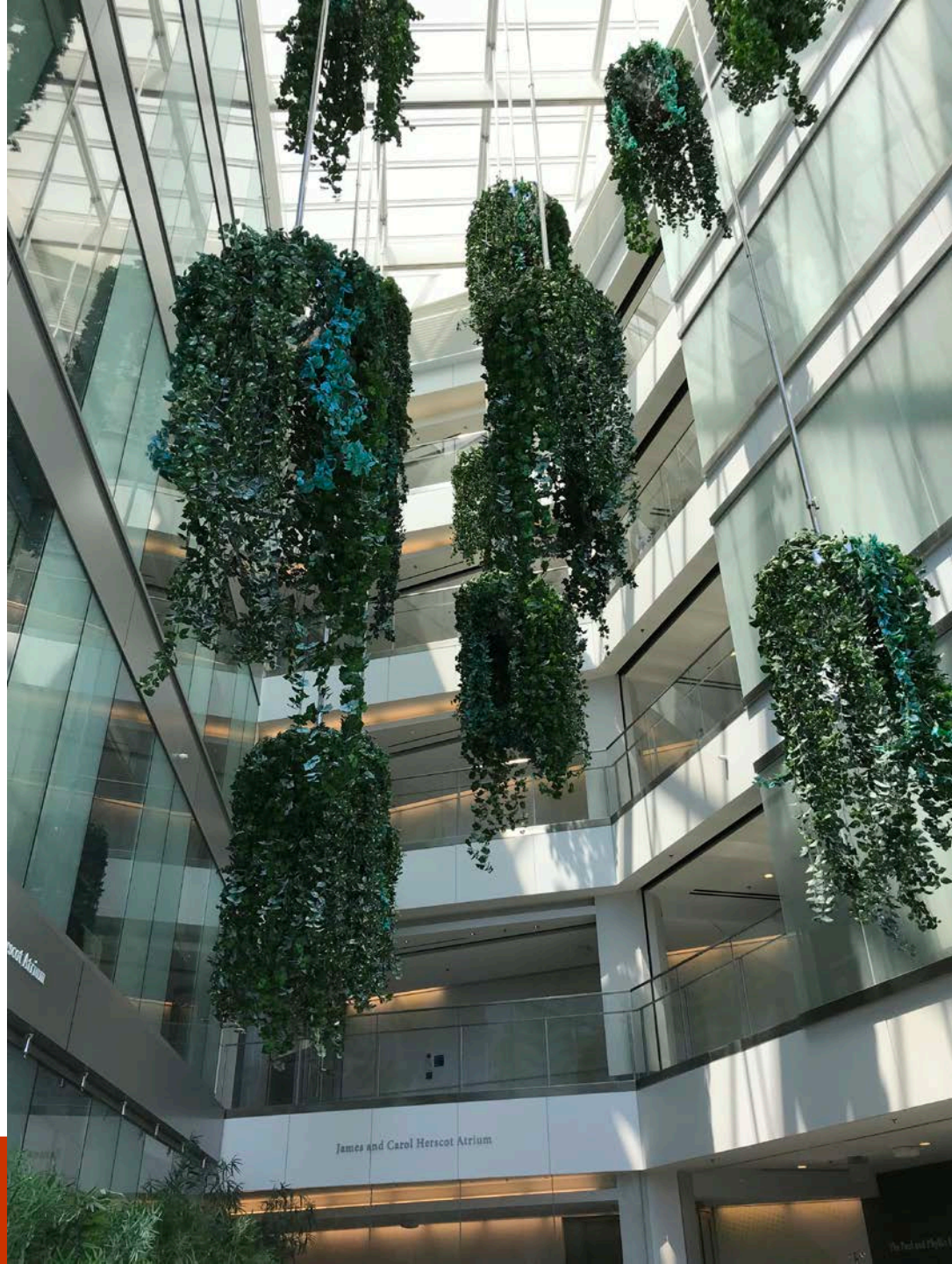




scot Atrium

James and Carol Herscot Atrium





James and Carol Herscot Atrium

James and Carol Herscot Atrium

The First and Fifth









# Green Roof Benefits:

- Planting reduces *urban heat island effects*
- planting can be used to absorb rain water and decrease water that must be processed by the urban storm sewer system
- visually pleasing
- additional insulation
- City of Toronto now has a Green Roof By-law that requires Green Roofs on new commercial buildings.

# Green Roof Drawbacks:

- Why not do a green roof?
- Additional first expense
- additional structure required to support roof
- plants must be hardy and not need watering (over the long term)
- watering essential during the first 2 or so years until roots become established
- Does not benefit insulation as materials are damp so conductive rather than insulative